



# SAMPLE PREPARATION FUNDAMENTALS FOR CHROMATOGRAPHY

The Measure of Confidence



Agilent Technologies



## Table of Contents

<b>Chapter 1</b>	Introduction.....	1
<b>Chapter 2</b>	Types of Samples and Overview of Approaches to Processing.....	9
<b>Chapter 3</b>	General Considerations in Sampling .....	17
<b>Chapter 4</b>	The Sampling and Sample Handling of Solid Materials.....	20
<b>Chapter 5</b>	Filtration .....	29
<b>Chapter 6</b>	Sample Introduction and Sample Preparation of Volatile Organic Compounds .....	35
<b>Chapter 7</b>	Sample Pre-treatment for Liquid Samples .....	55
<b>Chapter 8</b>	QuEChERS, Salting Out Liquid-Liquid Extraction, and Related Techniques .....	78
<b>Chapter 9</b>	Solid Phase Extraction (SPE).....	94
<b>Chapter 10</b>	Special Topics in SPE.....	133
<b>Chapter 11</b>	Size-Exclusion Chromatography as a Sample Preparation Technique .....	160
<b>Chapter 12</b>	Column/Flash Chromatography as a Sample Preparation Technique .....	170
<b>Chapter 13</b>	Column-Switching (On-Line SPE) as a Sample Preparation Technique .....	172
<b>Chapter 14</b>	Sample Preparation Methods for Solid Samples .....	181
<b>Chapter 15</b>	Sample Preparation for Biological Samples.....	195
<b>Chapter 16</b>	Sample Preparation in Bioanalysis .....	227
<b>Chapter 17</b>	Sample Pre-treatment for LC/MS.....	255
<b>Chapter 18</b>	Membrane Techniques in Sample Preparation .....	269
<b>Chapter 19</b>	The Role of Scavengers in Sample Preparation.....	281
<b>Chapter 20</b>	Derivatization for HPLC and GC Analysis .....	286
<b>Chapter 21</b>	<i>Just Enough</i> Sample Preparation: A Proven Trend in Sample Analysis.....	297
<b>Chapter 22</b>	Current Trends and Future Directions in Sample Preparation .....	307
<b>Chapter 23</b>	Glossary .....	310
	Index .....	343
	Matrix/Analyte Index.....	351

## Preface

Since most samples encountered in a chromatography laboratory are not in a form to be directly placed into the analytical instrument, some form of preparation is required for nearly every sample. The sample preparation could be as simple as “dilute and shoot” or as complex as multistage sample handling. The analytical cycle represents all of the steps from the point of collection to the final analysis and data output. Although sample preparation is an important part of this analytical cycle, it doesn’t always get the respect as does the separation and measurement instrumentation and the data handling aspects. Oftentimes, the task of sample preparation employs decades old technology that is often manual, time-consuming and uses a lot of glassware and other devices, and some older technologies use copious amounts of solvent that must eventually be disposed of, creating expense and safety issues. Because of the use of multiple sample preparation steps in an attempt to simplify and/or isolate the desired analytes from a complex matrix, errors tend to creep into the assay and analyte recoveries may suffer.

The purpose of this book is to outline some of the most popular sample preparation technologies in current use today. Since sample preparation technologies is represented by tens of possible sample manipulations (e.g. weighing, dissolution, extraction, trapping, etc.), I didn’t set out to cover every single sample prep category. The book started out to be a small handbook like the popular *The LC Handbook: Guide to LC Columns and Method Development* (Publication Number 5990-7595EN) but soon blossomed into a 350+ page book covering many different sample preparation technologies. Since the book was written for Agilent Technologies, many of the methodologies covered are those within Agilent’s chemistries portfolio, but for the sake of completeness, I have covered a number of technologies outside of Agilent’s immediate areas of interest. Examples of applications are provided throughout the book and many of them are web-accessible.

Since this book is primarily designed for the chromatography laboratory and to keep the length reasonable, I had to confine my coverage to organic and biological sample preparation and thus inorganic sample prep, although important in chromatographic and obviously the spectroscopic analyses of many sample types, was omitted. Many of the techniques covered, however, such as ion exchange SPE, liquid-liquid extraction and microwave-assisted extraction are equally applicable to inorganic samples for further analysis by ion chromatography or for spectroscopic measurements.

I have written the book in a slightly different format than might be typical. After an introductory Chapter 1 on the sample prep process, in Chapter 2, I decided to tabulate most of the methodologies that will be covered in the remainder of the book. That way, the reader, rather than wading through all the various chapters, can get an overview of possible sample preparation methods that are most applicable to gases, liquids, suspensions, gels and solid materials. So the reader can get directly to the sample prep methodology that may suit his/her particular sample. In subsequent Chapters, rather than repeating all the information, I refer back to these tables. The book is organized by the flow of sample preparation process (sampling, transport, storage all the way up to sample filtration and, in some cases, sample introduction).

The Chapters are further organized by sample types so that gaseous samples are first (Chapter 6) followed by liquid samples (or samples put into a liquid form) (Chapters 7-12), solid samples (Chapter 14), biological samples (nucleic acids and proteins)(Chapter 15), biological fluids/tissues (Chapter 16) and then special topics such as sample prep for mass spectrometry, membrane applications, chemical scavengers, and derivatizations. Finally, Chapter 21 covers a new concept of “Just Enough” sample preparation that seems to be today’s trend relying heavily on the increased use of hyphenated-chromatography/tandem mass spectrometry techniques. To aid the novice (and maybe some of the experts!) on the terminology associated with sample prep, the final Chapter 22 includes a Glossary.

I wish you good reading and hope that the material within provides you with a good foundation on how to best approach your sample preparation challenges.

Ronald E. Majors, Wilmington, DE

## Acknowledgements

First and foremost, I would like to thank my wife, Carol, for giving up part of our retirement time allowing me to work on this book and for her support during this process. I would also like to thank Helen Stimson, my boss at Agilent, for allowing me to work ½ time combining my pending retirement with my passion for science, especially sample preparation technologies. I would also like to thank the three Agilent Marcom ladies (Christine Cox, Anne Batchelor, and, especially Nicole Goodman who managed the bulk of the effort) for helping me get this volume to press. Special thanks go to Agilent colleagues: to Edward Elgart who proofread the entire book, to Gina Goggins for her helpful suggestions and locating some of the figures to use as examples and to Dennis Blevins who gave excellent detailed feedback on the technical aspects of most of the chapters. In addition, I would like to thank Agilent sample prep and chromatography colleagues who read specific chapters and gave their feedback. This feedback helped to shore up the usefulness of the information and with helpful suggestions on where improvements could be made: Trisa Robarge, Nigel Simpson, Christophe Deckers, Bill Wilson, Jared Bushey, Limian Zheo, Michael Woodman, Sue Cohen, Tina Chambers, Jennifer Massi, Derick Lucas and Bruce Richter and finally to Vanita Marshall who kept track of and contact with all of the reviewers.

Last but not least, I would like to thank *LCGC No. America* for allowing me to use some of the published information and artwork used in various articles over the years from my monthly columns, *Column Watch* and *Sample Preparation Perspectives*.

Ronald E. Majors, Wilmington, DE





# Introduction

The major stages of an analytical process are depicted in **Figure 1.1**. The proper choice of the measurement technique is only one step in the development of a successful application. All of the steps leading up to the measurement are as important. The sampling and sample preparation process begins at the point of collection and extends to the measurement step. The proper collection of sample during the sampling process (called primary sampling) is the initial contact with the sample and it is imperative that this sample represents the entire lot being investigated. The storage, preservation and transport of this representative sample from the point of collection to the analytical laboratory must occur without any changes in the physical and chemical makeup of the original sample. The proper selection of the laboratory sample itself (termed secondary sampling) represents another challenge since the final sample used for analysis may be a tiny fraction of the original collected sample, yet serves as a subset. Finally, the sample preparation methodology necessary to convert the sample into a form suitable for the measurement step must also be performed without loss or any unplanned modification of the secondary sample. All of these pre-analysis steps can have a greater effect in the overall accuracy and reliability of the results than the measurement itself.

Figure 1.1

## Sample Analysis Workflow Diagram

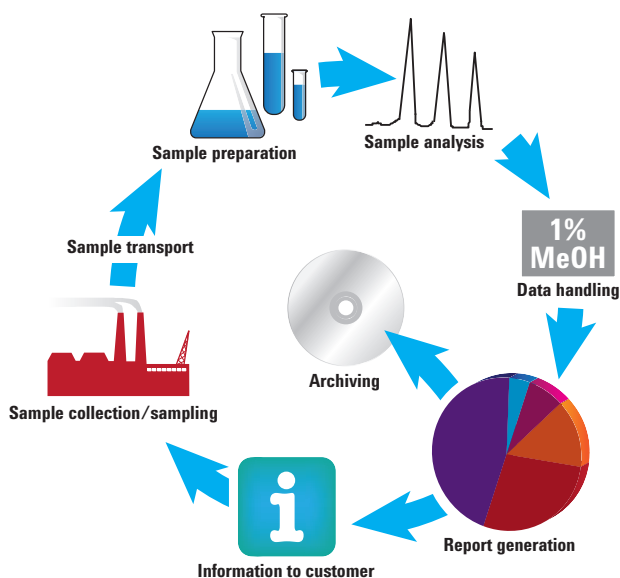

Sample preparation is an essential part of chromatographic and spectroscopic analyses. The process is intended to provide a representative, reproducible, and homogenous solution that is suitable for injection into the column for chromatographic analysis, or into an ICP-MS/atomic adsorption source, or into a cuvette or NMR tube for further characterization. The aim of sample preparation is to provide a sample aliquot that (a) is relatively free of interferences, (b) will not damage the column or instrument and (c) is compatible with the intended analytical method. In chromatography, the sample solvent should dissolve in the HPLC mobile phase or be injectable into a GC column without affecting sample retention or resolution, the stationary phase itself, and without interfering with detection. It is further desirable to concentrate the analytes and/or derivatize them for improved detection or better separation. In spectroscopy, the sample solvent should be free of particulates, compatible with the spectroscopic source, and be of the appropriate viscosity to flow into a nebulizer for on-line methods. Sometimes, depending on spectroscopic sensitivity, preconcentration is needed and chromatography or liquid-liquid extraction is sometimes used prior to introduction of the sample into the instrument.

Although many of the sample preparation protocols used in chromatography and spectroscopy are similar, it is beyond the scope of this book to address the various differences between sample preparation procedures for these diverse methods. Therefore, we will limit the topics in this handbook to the popular sample preparation methods for chromatographic analysis with emphasis on Liquid Chromatography (LC)/High Performance LC (HPLC)/Ultra HPLC (UHPLC), and Gas Chromatography (GC).

A more detailed depiction of the various operations in the analytical cycle is summarized in **Table 1.1**. If particular attention is not paid to all of these operations, sample integrity may be sacrificed and the analysis data affected, compromised, or rendered invalid. Steps 1-5, which include 1) sample collection, 2) storage and preservation, 3) sample transport, 4) preliminary processing and laboratory sampling, and 5) weighing or dilution, all form an important part of sample preparation. Although these steps in the chromatographic assay can have a critical effect on the accuracy, precision, and convenience of the final method, space limitations preclude us from addressing all of these areas in detail. Only steps 1 and 4 (sample collection and preliminary sample processing) will be briefly explained here. See References 1-4 for an explanation of steps 2, 3, and 5. The bulk of this book will be devoted mainly to Steps 6-9 of **Table 1.1**, which encompasses what is usually meant by sample pre-treatment or sample preparation ("sample prep").



Table 1.1

Sample Pre-treatment Options		
Step	Option	Comment
1	Sample collection	Obtain representative sample using statistically valid processes.
2	Sample storage and preservation	Use appropriate inert, tightly-sealed containers; be especially careful with volatile, unstable, or reactive materials; stabilize samples, if necessary; biological samples may require refrigeration or freezing.
3	Sample transport	The act of transporting the sample from the point of collection to the laboratory can be an important step. Transportation conditions should maintain its integrity, samples should not have rough handling, be dropped, or be allowed to be exposed to the elements; the timing may be important for samples – undue delays may cause sample degradation as in step 2 above.
4	Preliminary sample processing	Sample must be in form for more efficient sample pre-treatment (e.g. drying, sieving, grinding, etc.); finer dispersed samples are easier to obtain representative sample and to dissolve or extract.
5	Weighing or volumetric dilution	Take necessary precautions for reactive, unstable, or biological materials; for dilution, use calibrated volumetric glassware.
6	Alternative sample processing methods	Solvent exchange, desalting, evaporation, freeze drying, etc.
7	Removal of particulates	Filtration, centrifugation, solid phase extraction.
8	Sample extraction	Method for liquid samples (Table 2.4) and solid samples (Tables 2.2 and 2.3)
9	Derivatization	Mainly to enhance analyte detection; sometimes used to improve separation, extra step in analytical cycle adds time, complexity, and potential loss of sample (See Chapter 20).

Whereas GC and HPLC are predominantly automated procedures, sample pre-treatment is often performed manually. As a result, sample pre-treatment can require more time for method development and routine analysis than is needed for the separation and data analysis (see **Figure 1.2**). Sample pre-treatment may include a large number of methodologies, as well as multiple operational steps, and can therefore be a challenging part of chromatographic method development.

Figure 1.2

### Time Spent on Typical Chromatographic Analysis

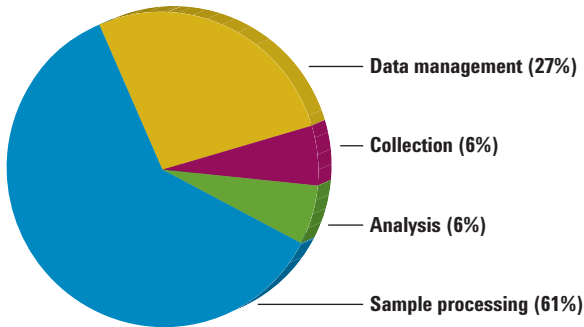

Data taken from Agilent Technologies survey

Finally, method precision and accuracy is frequently determined by the sample pre-treatment procedure (see **Figure 1.3**), including operations such as weighing and dilution. For all of these reasons, the development of a sample pre-treatment procedure deserves careful, advance planning.

Figure 1.3

### Sources of Error Generated During Chromatographic Analysis

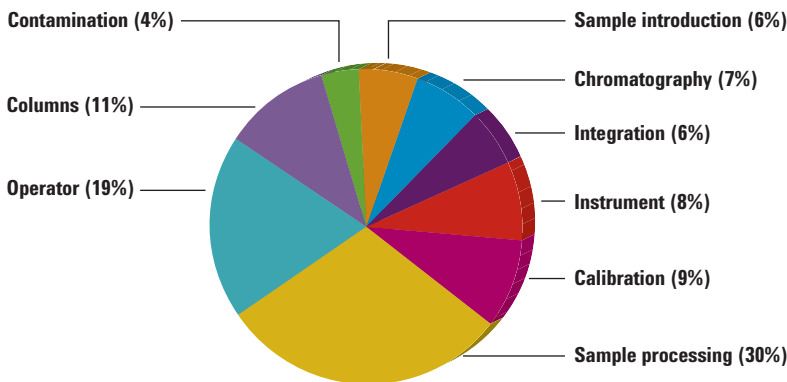

Data taken from Agilent Technologies survey

A sample pre-treatment procedure should provide quantitative recovery of analytes, involve a minimum number of steps, and (if possible) be easily automated. Quantitative (99+%) recovery of each analyte enhances sensitivity and assay precision, although this does not mean that all of the analyte present in the original sample must be included in the final injected sample. For example, in a given method, for a series of sample pre-treatment steps, aliquots of intermediate fractions may be used for further sample preparation or for an intermediate injection. If recovery is not 100%, the sample pre-treatment must be reproducible. The use of internal standards or standard addition are approaches to aid in better quantitation, when recovery is not complete. As implied in **Figure 1.3**, a smaller number of sample pre-treatment steps plus automation reduces the overall time and effort required, and decreases the opportunity for imprecision and accuracy errors by the analyst. Thus, depending on the chromatographic and detection selectivity available, one should attempt to use as few sample pre-treatment steps as possible. In other words, sufficient sample preparation should be performed to meet the goals of the analysis, dependent on selectivity available in other parts of the analysis system (e.g. chromatography, detection), sufficient sample preparation may entail multiple steps and techniques. This concept is thoroughly explained in Chapter 21.

Many sample preparation techniques have been automated, and usually appropriate instrumentation is commercially available. Approaches to automation vary from use of a robot to perform manual tasks to dedicated instruments optimized to perform a specific sample preparation technique. While automation can be expensive and elaborate, it is often desirable when large numbers of samples must be analyzed and the time or labor per sample is excessive. The decision to automate a sample pre-treatment procedure is often based on a cost justification, the availability of instrumentation to perform the task at hand, or in some cases, when operator safety is involved (i.e. to minimize exposure to toxic substances or other possible health hazards). Sample preparation instrumentation for automation will be briefly addressed here, but it is beyond the scope of this book to elaborate further on the details of commercial instrumentation. Refer to textbooks on the subject listed under references 5-7.

**Table 1.2**

As you embark on using the remainder of this book, there are many questions that you must consider before deciding which sample preparation technique may be the best for your particular sample. **Table 1.2** is a sample preparation worksheet that provides some guidance in consideration of the goals of your analytical method and sample preparation including analyte and matrix questions. Because there are so many terms associated with sample preparation, a Sample Preparation Glossary is provided in the Appendix of this book. For abbreviations and definitions that you may encounter, please refer to the Glossary.

<b>Sample Preparation Worksheet</b>		
<b>Sample Preparation Questions</b>	<b>Example/Considerations</b>	<b>Comments</b>
What is analytical measurement technique?	LC-UV, LC/MS, GC/MS, etc.	Final sample must be compatible with analytical technique.
What is your optimal analytical run time?	1 min, 10 min, .5 hour, longer	Sample prep time may exceed run time; can you batch samples?
What level of recovery is required to meet LOD/LOQ?	100% only, less than 100%	100% recovery is ideal, but the more sample prep steps you have, the greater opportunity for loss; even so, RSD may still be acceptable at lower recovery if "loss" is reproducible.
How do you plan to quantitate?	External standard or internal standards?	Are standards available? Can you find internal standard(s) that are resolved from analytes of interest? Do you need multiple internal standards?
What is your required accuracy and precision?	Consider both inter- and intra-day values	For trace levels (e.g. sub-ppb) RSDs may be greater than you expect; must determine recovery, precision and accuracy at levels expected in your samples (minimum of 3 levels).
What is the sample matrix?	Organic, biological, inorganic, solid, semi-solid, liquid, gel, gas, etc.	Must choose sample prep technique that can selectively remove analytes of interest from the matrix.
How much do you know about the sample matrix?	Oil-based vs. aqueous-based, high salt content, volatile, unstable; is the sample matrix polar or non-polar, ionic, ionizable?	Must begin early to think about sample prep technique to best differentiate the properties of your analyte and matrix.

(Continued)

## Sample Preparation Worksheet

Sample Preparation Questions	Example/Considerations	Comments
What is the sample volume/mass?	Microliter vs. liter, mg vs kg, etc.	Must have equipment and glassware available to handle size of sample required.
What key interferences are endogenous to the sample?	Are interferences more like matrix or like your analytes?	May require more than one sample prep technique for cleanup of interferences that are similar to your analytes of interest.
What functional groups on your matrix, interferences and analyte(s) of interest may influence choice of sample prep technique?	Influences solubility, polarity, ionization states (pKa)	Often don't know the actual structures of matrix and interferences to help make rational decision.
What else is already known about analyte(s) itself?	Water-octanol partition coefficients, concentration range, chemical structure	May allow you to direct your attention to capturing the analyte itself and rely upon the chromatography and/or detection step(s) to resolve it from any co-extracted interferences and matrix components.
What is level of interference removal required for analysis?	Depends on selectivity of chromatography separation and detection	Must avoid ion suppression/enhancement effects in LC/MS (and MS-MS); for UV and less selective detectors, and other, must have better sample prep and chromatography selectivity.
What sample pre-treatment steps may be required?	Dilution, clarification, filtration, pH adjustment, etc.	May be required for best overall selectivity, but each additional step can lead to analyte loss and affect accuracy/precision.
Is a concentration step required for optimal analysis?	Solvent evaporation, purge and trap, etc.	Concentration steps add time to analysis but may be required to meet LOC/LOQ.
What solvent should the analyte(s) be in for optimal analysis?	Avoid solvents that may cause UV interference, MS ion suppression, GC stationary phase compatibility, or non-volatile	Choice of solvents for sample prep final step may be limited; can always evaporate to dryness and re-dissolve in compatible solvent; increases time and number of steps.
What resources are available for method development and routine analysis?	High sample loads may require some level of automation; do you have the right sample prep tools available in your lab?	Sample prep may require more personnel since it is often more labor intensive and time consuming than the analytical measurement.

## References

---

1. Keith, L.H. (Ed.) *Principles of Environmental Sampling (ACS Professional Reference Book)*, 2nd Ed., American Chemical Society, Washington, DC, **1996**, ISBN-10: 0841231524 and ISBN-13: 978-0841231528.
2. Pawliszyn, Janusz, (Ed.) *Comprehensive Sampling and Sample Preparation: Analytical Techniques for Scientists*, Academic Press, Waltham, MA, **2012**, ISBN-10: 0123813735 and ISBN-13: 978-0123813732.
3. Svarc-Gajic, Jaroslava (Ed.) *Sampling and Sample Preparation in Analytical Chemistry, (Chemistry Research and Applications: Chemical Engineering Methods and Technology)*, Nova Science Pub Inc., Hauppauge, NY, **2011**, ISBN-10: 1621002691 and ISBN-13: 978-1621002697.
4. Conklin, Alfred R., Jr. *Field Sampling: Principle and Practices in Environmental Analysis*, Marcel-Dekker, New York, **2004**.
5. Moldoveanu, S.C.; David, V. *Sample Preparation in Chromatography (J. Chromatography Library)*, Elsevier Science, San Diego, CA, **2002**.
6. Wells, D.A. *High-Throughput Bioanalytical Sample Preparation: Methods and Automation Strategies*, Elsevier Science, San Diego, CA, **2003**, ISBN-10:044451029X and ISBN-13: 978-0444510297.
7. Nickerson, B. (Ed.) *Sample Preparation of Pharmaceutical Dosage Forms: Challenges and Strategies for Sample Preparation and Extraction*, Springer, New York, **2011**, ISBN-10:1441996303 and ISBN-13:978-1441996305.



# Types of Samples and Overview of Approaches to Processing

Sample matrices can be broadly classified as organic, biological or inorganic, and may be further subdivided into solids, semi-solids (including creams, gels, suspensions, colloids), liquids, and gases. For nearly every matrix, some form of sample pre-treatment, even if it is just simple dilution, will be required prior to chromatographic analysis.

Gaseous samples usually are analyzed by gas chromatography, rather than HPLC. Techniques such as canister collection, direct sampling via sample loops, headspace sampling and purge and trap are used to collect and inject gases. In Chapter 6, we will briefly cover those sampling/sample prep techniques primarily used for gas samples. **Table 2.1** provides an overview of typical sampling, sample introduction, and sample preparation procedures used for gaseous volatile samples.

Table 2.1

Typical Sampling and Sample Pre-treatment Methods for Gaseous Samples		
Method of Sample Pre-treatment	Principles of Technique	Comments
Grab Sampling	Gaseous sample is pulled into an evacuated glass, metal bulb or canister, or by a syringe; gas can also be pumped into plastic bag or other inert container.	Used mostly for volatile compounds in air; samples are returned to laboratory and analytes are isolated and concentrated by cold trapping techniques.
Solid Phase Trapping	Gaseous sample passed through tube packed with adsorbent (e.g. silica gel, activated carbon); trapped analytes are eluted with strong solvent.	Used for semivolatile organic compounds in air; control of gas flow rate is critical for trapping efficiency; watch for aerosol formation, adsorbent overloading, and irreversible adsorption of reactive analytes; popular sorbents include silica gel, alumina, porous polymers (Tenax, polyurethane foams), or carbon; chemical or physical complexing reagents may be useful to improve trapping efficiency.
Liquid Trapping	Gaseous sample is bubbled through solution that is a good solvent for analytes; analyte has higher affinity for solvent than it does for gas.	Flow rate should be low enough so as not to create foams or aerosols; complexing agents may be added to solvent to aid trapping; temperature can be lowered for very volatile species; sometimes process IS called "impinging."

(Continued)

Table 2.1 (Continued)

Typical Sampling and Sample Pre-treatment Methods for Gaseous Samples		
Method of Sample Pre-treatment	Principles of Technique	Comments
Headspace Sampling	Sample (solid or liquid) is placed in a closed, thermostated glass vial until equilibrium is established; at equilibrium, analytes partition themselves between a gas phase and the solid (or liquid) phase at a constant ratio; gas phase is sampled and injected into GC for analysis.	Used primarily for determination of trace concentrations of volatile substances in samples difficult to handle by conventional GC techniques; sensitivity can be increased by heating (<100 °C), salting out, adjusting pH, and other means to shift equilibrium; sometimes water or solvent is added to aid in sample dispersion and/or to free organics from the matrix, especially for soils and sediments; can be manual or automated.
Purge and Trap (Dynamic Headspace)	Sample (solid or liquid) is placed in closed, thermostated container and the headspace vapors are continually removed by means of inert gas flow with subsequent trapping of sample components by solid phase extraction or cold trapping; then thermally desorbed into GC injection port (thermal desorption).	Used when analytes are too low in concentration or have unfavorable partition coefficients in static headspace (HS) sampling (sometimes called gas phase stripping) can provide more sensitivity than static HS by accumulating the volatiles until concentration is sufficiently built up for thermal desorption and GC analysis; can be manual or automated.
Thermal Desorption	Used in conjunction with purge and trap and solid phase microextraction to concentrate volatile analytes; sorbent is rapidly heated to transfer concentrated analytes to GC by purge gas.	Typical adsorbent resins include Tenax TA, glass beads, Carbosieve, Carboxen, and Carbotrap. Sorbent choice based on specificity, breakthrough volume, water affinity, bed volume, and range of organics sorbed/desorbed from resin; can be cryogenically cooled to trap volatile organics.
Direct Thermal Extraction	A form of dynamic headspace, but the sample is heated (controlled) to much higher temperatures, up to 350 °C.	System must be constructed of fused quartz or fused silica so that extracted analytes do not react with hot metal surfaces; system cold spots should be avoided; used primarily for semi-volatile compounds.
Pyrolysis	Non-volatile large molecule sample (e.g. polymer, plant fiber) is thermally degraded to cleave linkages and produce smaller, more volatile molecules that are swept into GC or to adsorbent trap (cryogenic) for separation and identification.	Degradations often have defined mechanisms and sample may break apart in a predictable manner; can lead to structural information about starting compound or provide "fingerprints" for comparative profiles; pyrolysis can be performed in inert or reactive atmosphere.
Solid Phase Microextraction (SPME)	Fused silica fiber coated with polymeric stationary phase is placed in headspace above sample or directly into liquid sample; analytes diffuse and partition/adsorb onto stationary phase; analytes are thermally desorbed by placing fiber into GC injection port or displaced by means of a liquid to a column for HPLC analysis.	SPME is an equilibrium sampling method and can be used for gases, solids (Headspace) and liquids (direct); various polymer coating formulations available (e.g. polydimethylsiloxane (PDMS), polyacrylate, Carbowax-divinylbenzene, Carboxen-PDMS); can work with small sample sizes, is field transportable, and uses no organic solvent; very volatile analytes can sometimes be lost and quantitation is problematic.

Volatile analytes that are labile, thermally unstable, or prone to adsorb to metal surfaces in the vapor state are sometimes better handled by HPLC. Trapping is required to analyze gaseous samples by HPLC. The gas sample is either (a) passed through a solid support and subsequently eluted with a solubilizing liquid, or (b) bubbled through a liquid that traps the analyte(s). An example of the HPLC analysis of a gaseous sample is the American Society for Testing Materials (ASTM) Method D5197-03 and United States Environmental Protection Agency Method TO-11 for volatile aldehydes and ketones<sup>1,2</sup>. In this example, an air sample is passed through an adsorbent trap coated with 2,4-dinitrophenylhydrazine, which quantitatively converts aldehydes and ketones into 2,4-dinitrophenylhydrazones. The hydrazones are then eluted with acetonitrile and separated by reversed-phase HPLC.

Sample preparation for solid samples can often be more demanding. Samples that are solid (or semi-solid) must usually be put into a liquid form – unless the volatile portion only is of interest and then headspace, purge and trap, or thermal desorption techniques (covered in Chapter 6) are used to isolate, and perhaps concentrate, that portion of the sample. In some cases, the sample is easily dissolved and is then ready for injection or further pre-treatment. In other cases, the sample matrix may be insoluble in common solvents, and the analytes must be extracted from the solid matrix. There are also cases where the analytes are not easily removable from an insoluble matrix because of inclusion or adsorption. If the solvent-extractable portion of a solid sample is of interest, then techniques such as liquid-solid extraction, supercritical fluid extraction, microwave-assisted extraction, Soxhlet extraction, or pressurized fluid extraction can be used (see Chapter 14). Here, the solid material is exposed to a solubilizing liquid or supercritical fluid (usually carbon dioxide, often doped with a polar solvent such as methanol), sometimes with added heat and/or pressure. Sample components soluble in the liquid eventually are totally or partially leached out of the sample. Obviously, the more porous the sample and the more finely divided the solid sample, the easier it is to extract components.

If the entire solid sample is to be analyzed, more drastic dissolution techniques or stronger solvents may be required. For example, a rock sample or metal may require digestion with a strong acid to completely solubilize it and then the liquified sample further treated to isolate components of interest. **Table 2.2** lists some traditional methods for the recovery of analytes from solid samples, while **Table 2.3** describes additional recent procedures. Once analytes have been quantitatively extracted from a solid sample, the resulting liquid fraction can either be injected directly into the HPLC or GC instrument, or subjected to further pre-treatment. Chapter 14 provides more details on the extraction of solid samples while Chapter 16 provides information on the extraction of solid- and semi-solid-biological samples, such as tissue.

Table 2.2

Traditional Methods for Sample Preparation of Solid Samples		
Method of Sample Pre-treatment	Principles of Technique	Comments
Solid-Liquid Extraction	Sample is placed in closed container and solvent is added that dissolves/extracts/leaches the analyte of interest; solution is separated from solid by filtration (sometimes called "shake/filter" method).	Solvent is sometimes boiled or refluxed to improve solubility; sample is in finely-divided state to aid leaching process; sample can be shaken manually or automatically; sample is filtered, decanted, or centrifuged to separate from insoluble solid.
Soxhlet Extraction	Sample is placed in disposable porous container (thimble); constantly refluxing fresh solvent flows through the thimble and dissolves analytes that are continuously collected in a boiling flask (see Chapter 14).	Extraction occurs in pure solvent; sample must be stable at boiling point of solvent; slow but extraction is carried out unattended until complete; inexpensive; best for freely flowing powders; excellent recoveries (used as standard to which other solid extraction methods are compared).
Homogenization	Sample is placed in a blender or a mechanical homogenizer, solvent is added, and sample is homogenized to a finely divided state; solvent is removed for further workup.	Used for plant and animal tissue, food, environmental samples; organic or aqueous solvent can be used; dry ice or diatomaceous earth can be added to make sample flow more freely; small dispersed sample promotes more efficient extraction.
Sonication	Use of ultrasound to create vigorous agitation at the surface of a finely divided solid material; direct method: uses a specially designed inert acoustical tool (horn or probe = sonotrode) placed in sample-solvent mixture; indirect method: sample container is immersed in ultrasonic bath with solvent and subject to ultrasonic radiation.	Dissolution is aided by ultrasonic process; heat can be added to increase rate of extraction; safe; rapid; best for coarse, granular materials; for indirect method, multiple samples can be done simultaneously; efficient contact with solvent.
Dissolution	Sample is treated with dissolving solvent and taken directly into solution with or without chemical change.	Inorganic solids (e.g. minerals, metals) may require acid or base digestion to completely dissolve; organic samples can often be dissolved directly in solvent; biological samples may not fully dissolve; for many sample types, filtration may be required after dissolution.

Compared to gases or solids, liquid samples are much easier to prepare for chromatographic analysis.

Table 2.3

<b>Modern Extraction Methods for Solid Samples</b>		
<b>Method of Sample Pre-treatment</b>	<b>Principles of Technique</b>	<b>Comments</b>
Pressurized Fluid Extraction (PFE)/Accelerated Solvent Extraction (ASE)	Sample is placed in a sealed container and heated to above its boiling point causing, pressure in vessel to rise; extracted sample is removed and transferred to vial for further treatment.	Greatly increases speed of liquid-solid extraction process; may be automated; vessel must withstand high pressure; extracted sample is diluted and requires further concentration; safety provisions are required because of overpressured, high temperature solvents.
Automated Soxhlet Extraction	A combination of hot solvent leaching and Soxhlet extraction; sample in thimble is first immersed in boiling solvent, then thimble is raised for conventional Soxhlet extraction/rinsing with solvent refluxing and finally concentration.	Semi-automated and automated versions available; uses less solvent than traditional Soxhlet, solvent is recovered for possible reuse; decreased extraction time due to two-step process.
Supercritical Fluid (SF) Extraction	Sample is placed in flow-through container and supercritical fluid (e.g. CO <sub>2</sub> ) is passed through sample; after depressurization, extracted analyte is collected in solvent or trapped on adsorbent followed by desorption by rinsing with solvent.	Automated and manual versions available; to affect "polarity" of SF fluid, density (vary temperature and/or pressure) can be varied and solvent modifiers added; collected sample is usually concentrated and relatively contaminant-free because CO <sub>2</sub> volatilizes after extraction; matrix affects extraction process; thus method development may take longer than other modern methods.
Microwave-Assisted Extraction	Sample is placed in a solvent in an open or closed container and contents heated by microwave energy causing a temperature rise and extraction of analyte.	Extraction solvent can range from microwave absorbing (MA) to non-microwave absorbing (NMA); in MA case, sample is placed in high pressure container and heated well above its boiling point as in PFE/ASE; in NMA case, microwave absorbing device placed container so solvent is indirectly heated; safety provisions are required with organic solvents in microwave oven (MA/NMA) and high pressures of MA example.

(Continued)

## Modern Extraction Methods for Solid Samples

Method of Sample Pre-treatment	Principles of Technique	Comments
Gas Phase Extraction	After equilibrium, analytes partition themselves between a gas phase and the solid phase at a constant ratio; static headspace: volatiles sampled above solid; dynamic headspace (purge & trap): volatiles sampled by continuously purging headspace above sample with inert gas and trapped on a solid medium, then thermally desorbed into GC; membrane can be used as interface between sample and flowing gas stream for added specificity.	Headspace techniques used for volatile analytes in solid samples; heat (usually <100 °C) can be applied to sample to speed up volatilization process; sometimes water or solvent is added to aid in sample dispersion and/or to free organics from the matrix, esp. for soils and sediments; both static and dynamic headspace techniques have been automated; dynamic techniques are more sensitive; microwaves have been used for heating.
Matrix Solid Phase Dispersion (MSPD)	Technique uses bonded phase supports as an abrasive to produce disruption of sample matrix architecture and as a "bound" solvent to aid complete sample disruption during the sample blending process.	Solid or viscous sample (approx. 0.5 g) is placed in mortar with about 2 g of SPE sorbent (e.g. C18) and is blended to homogenized mixture; sometimes solvent is added to aid extraction process; blend is transferred to column and analytes are eluted with solvent, sometimes to an SPE layer for further cleanup prior to injection; a "solid-solid" extraction process.

Many HPLC analyses are based on a "dilute and shoot" procedure, where the solubilized analyte concentration is reduced by dilution so as to not overload the column or saturate the detector. Often, liquid samples can be directly injected into a gas chromatograph and the volatile compounds separated and detected. In some cases, non-volatile compounds of the liquid sample may deposit in the injector, retention gap, or at the head of the column. Special GC conditions may be required to remove or eliminate this possibility. An overview of popular sample preparation methods for liquids and suspensions are listed in **Table 2.4**.



Table 2.4

### Typical Sample Preparation Methods for Liquids and Suspensions

Methods of Sample Preparation	Principles of Technique	Comments
Solid Phase Extraction (SPE)	Similar to HPLC, sample is applied to, and liquid is passed through, a column packed solid phase that selectively removes analyte (or interferences); analyte can be eluted with strong solvent; in some cases, interferences are retained and analytes allowed to pass through solid phase unretained (Chapter 9).	Wide variety of stationary phases are available for selective removal of desired inorganic, organic, and biological analytes; specialty phases exist for drugs of abuse, carbohydrates, catecholamines, metal ions, trace enrichment of water, and many other classes of compounds.
Liquid-Liquid Extraction	Sample is partitioned between two immiscible phases which are chosen to maximize differences in solubility; interference-free analytes are then recovered from one of the two phases (Chapter 7).	Beware of formation of emulsions – break them with heat, addition of salt; values of $K_D$ can be optimized by the use of different solvents or additives (such as buffers for pH adjustment, salts for ionic strength, complexing agents, ion pairing agents, etc.); many published methods; continuous extractions for low $K_D$ values.
Dilution	Sample is diluted with solvent which is compatible with HPLC mobile phase or GC stationary phase; used to avoid column overload, to decrease solvent strength, or for the output signal to be within the linear range of detector.	To avoid excess peak broadening or distortion, dilution solvent should be miscible with, and preferably weaker than, the HPLC mobile phase; “dilute and shoot” is a typical sample prep method for simple liquid samples such as pharmaceutical formulations; for GC, too strong or an incompatible solvent should be avoided to protect coated stationary phases.
Evaporation	Liquid is removed by gentle heating at atmospheric pressure with flowing air or inert gas; vacuum is useful for low volatility liquids.	Do not evaporate too quickly; bumping can lose sample; watch for sample loss on wall of container; do not overheat to dryness; best under inert gas like $N_2$ ; rotary evaporator works best; automated systems evaporation systems available.
Distillation	Sample is heated to boiling point of solvent and volatile analytes in the vapor phase are condensed and collected.	Mainly for samples which can be easily volatilized; some samples can decompose if heated too strongly; vacuum distillation can be used for low vapor pressure compounds; steam distillation is rather gentle since maximum temp is 100 °C.
Microdialysis	A semi-permeable membrane is placed between two aqueous liquid phases and analytes transfer from one liquid to the other, based on differential concentration.	Enrichment techniques such as SPE are required to concentrate dialyzates; microdialysis is used for examination of extracellular chemicals in living plant and animal tissue, in fermentation broth; it has been used on-line with microLC columns; dialysis with molecular-weight cutoff membranes can also be used on-line to deproteinate samples prior to HPLC; ultrafiltration and reverse osmosis can be used in a similar manner.

(Continued)

## Typical Sample Preparation Methods for Liquids and Suspensions

Methods of Sample Preparation	Principles of Technique	Comments
Lyophilization	Aqueous sample is frozen and water removed by sublimation under vacuum.	Good for non-volatile organics; large sample volume can be handled; possible loss of volatile analytes; good for recovery of thermally unstable analytes, especially biological analytes; inorganics can be concentrated.
Filtration	Liquid is passed through paper or membrane filter or SPE cartridge/disk to remove suspended particulates.	Highly recommended to prevent HPLC backpressure problems and to preserve column life; keeps particulates out of capillary GC columns (Chapter 5)
Centrifugation	Sample is placed in tapered centrifuge tube and spun at high force (thousands to hundreds of thousands times gravity); supernatant liquid is decanted.	Centrifugation is used to remove particulates as an alternative to filtration; ultracentrifugation normally not used for simple particulate removal.
Sedimentation	Sample is allowed to settle when left undisturbed in a sedimentation tank; settling rate dependent on Stoke's radius.	Extremely slow process; manual recovery of different size particulates at different levels, depending on settling rate.
Solid Phase Microextraction (SPME)	see Table 2.1	see Table 2.1
Stir Bar Sorbent Extraction (SBSE)	Analogous to SPME except, the phase ratio is much larger; a magnetic stirring bar usually encased in glass is coated with a polymeric stationary phase. The coated stir bar is placed in a liquid or semi-liquid sample and analytes diffuse and partition/adsorb onto the stationary phase; after removal from the sample, stir bar is dried and like SPME analytes are thermally desorbed in a special desorption unit for GC or washed with an appropriate solvent for HPLC.	SBSE is also an equilibrium method, but because of the larger mass of sorbent on the coated bar, the sample capacity (and hence, sensitivity) of this technique may exceed the SPME technique by a couple of orders of magnitude; SBSE requires a special larger volume thermal desorption apparatus while SPME uses the GC injection port for thermal desorption. The technique is more difficult to automate than SPME.

### References

1. *Compendium Method TO-11A: Determination of Formaldehyde in Ambient Air Using Adsorbent Cartridge Followed by High Performance Liquid Chromatography (HPLC)*, Center for Environmental Research Information, Office of Research and Development, U.S. Environmental Protection Agency, Cincinnati, OH, **1999**.
2. Schneider, S. *Analysis of DNPH-Derivatized Aldehydes and Ketones Using the Agilent 1220 Infinity LC System with Diode Array Detector*, Agilent Application Note #5991-1545EN, **2013**.

# General Considerations in Sampling

The first stage in the analytical cycle is sampling (see **Figure 1.1**). The objective of sampling is a mass or volume reduction from the parent batch, which itself can be homogeneous or heterogeneous. Primary sampling is the process of selecting and collecting the sample to be analyzed. At first glance, the sampling of gases and liquids seems trivial, while the sampling of solids can represent a formidable task. Books have been written on the theoretical and practical aspect of the sampling process and how to collect a statistically representative sample<sup>1-4</sup>. It is beyond the scope of this chapter to provide primary sampling theory and methodology, but it suffices to say that it is one of the most overlooked sources of error in analysis.

Unfortunately, sampling is sometimes left to those unskilled in the proper methodology, and the analytical chemist in the laboratory may not be directly involved in the process, yet is left to provide a precise and accurate analysis of the provided sample. In the last several decades, sampling theory and practice have been largely ignored in the education process, especially for non-analytical chemists.

It is advisable to develop a well thought-out sampling plan as part of the overall analysis. Equally important to note is that sample information flow parallels sample flow throughout the analytical process from collection to report generation. For example, sample tracking begins at the point of collection and can be considered as part of the overall analysis process. Proper identification of the collected primary sample by handwritten labels, application of a bar code for automatic reading, writing on sample container with indelible ink, incorporation of RFI devices, or other means of documentation must be performed properly to ensure that later stages of processing can be traced unequivocally to the original primary sample. Likewise, each stage along the analytical process will require proper sample and sub-sample tracking to ensure that Good Laboratory Practices (GLP) are achieved.

# Sample Transport and Storage

Once the primary sample is taken, it must be transported to the analytical laboratory without a physical or chemical change in its characteristics. At first glance, this may seem to be a trivial task, but when the system under investigation is a dynamic entity, such as samples containing volatile, unstable, or reactive materials, the act of transportation can present a challenge, especially if the laboratory is a long distance from the point of collection. Even if a representative primary sample is taken, changes that can occur during transport can present difficulties in the secondary sampling process. Preservation techniques can be used to minimize any changes between collection and analysis. Physical changes such as adsorption, diffusion, and volatilization, as well as chemical changes such as oxidation and microbiological degradation, are minimized by proper preservation. Examples of preservation techniques that can be used between the point of collection to the point of sample preparation in the laboratory are:

- Choice of appropriate sampling container
- Addition of chemical stabilizers such as antioxidants and antibacterial agents
- Refrigeration or freezing the sample to avoid thermal degradation
- Adsorption on a solid phase

Once the sample has been brought into the laboratory, prior to analysis, storage conditions are equally important to maintain sample integrity. For thermally labile or volatile samples, the samples should be kept in sealed containers and stored in a refrigerator or freezer. Liquid samples should be kept in a cool, dark area (not exposed to sunlight) until ready for analysis. Samples that may be prone to oxidation or other chemical reaction should be stored in a vacuum desiccator until it is time for further sample handling and/or analysis.

For more information, references 4-7 address sampling and sample preparation of volatile samples, references 5-7 for water, air, and soil samples, and references 5, 8, and 9 for biological samples. Often, prepared laboratory standards, surrogate samples, and blanks are carried through the entire preservation, transport, and storage processes to ensure that sample integrity is maintained. A recent trend in both the industrial and environmental analyses has seen the analysis moving closer to the sample or the process. For example, portable field instruments are becoming more popular in the screening of environmental samples at the site of interest. Likewise, the movement of analytical measurements to at-line or on-line locations may have a profound effect on how samples are collected and analyzed in the future.

## References

---

1. Svarc-Gajic, J. (Ed.) *Sampling and Sample Preparation in Analytical Chemistry, (Chemistry Research and Applications: Chemical Engineering Methods and Technology)*, Nova Science Pub Inc., Hauppauge, NY, **2011**, ISBN-10: 1621002691 and ISBN-13: 978-1621002697.
2. Gy, P. *Sampling for Analytical Purposes*, Wiley, NY, **1998**, ISBN-10: 0471979562 and ISBN-13: 978-0471979562.
3. Pitard, F.F. *Pierre Gy's Sampling Theory and Sampling Practice, Heterogeneity, Sampling Correctness, and Statistical Process Control*, 2nd Ed., CRC Press, Boca Raton, FL, **1993**, ISBN-10: 0849389178 and ISBN-13: 978-0849389177.
4. Stoepler, M. (Ed.) *Sampling and Sample Preparation: Practical Guide for Analytical Chemists*, Springer, NY, **1997**, ISBN-10: 3642644864 and ISBN-13: 978-3642644863.
5. Pawliszyn, J. (Ed.) *Comprehensive Sampling and Sample Preparation: Analytical Techniques for Scientists*, Academic Press, Waltham, MA, **2012**, ISBN-10: 0123813735 and ISBN-13: 978-0123813732.
6. Stoepler, M. (Ed.), *Sampling and Sample Preparation: Practical Guide for Analytical Chemists*, Springer, Berlin, Germany, **2011**, ISBN-10:3642644864 and ISBN-13:978-3642644863.
7. Pawliszyn, J. *Sampling and Sample Preparation in Field and Laboratory, Volume 37: Fundamentals and New Directions in Sample Preparation*, Elsevier Science, San Diego, CA, **2002**, ISBN-10: 0444505105 and ISBN-13: 978-0444505101.
8. Ivanov, A.R.; Lazarev, A.V. (Eds.) *Sample Preparation in Biological Mass Spectrometry*, Springer, New York, **2011**, ISBN-10: 9400707584 and ISBN-13: 978-9400707580.
9. Venkatesh Lyengar, G.; Subramanian, K.S.; Woittiez, J.R.W. *Elemental Analysis of Biological Samples: Principles and Practices*, CRC Press, Boca Raton, FL, **1997**, ISBN-10: 0849354242 and ISBN-13: 978-0849354243.

# The Sampling and Sample Handling of Solid Materials

As indicated earlier, the sampling process is extremely important in order to ensure that the sample actually injected into the chromatograph represents the original sample that was collected in the field, on the production line, in the patient's body, or in the atmosphere. In this chapter, we will provide a basic review of the sampling process and discuss ways to put the sample in a form suitable for analysis.

## Sampling

Most solid materials occurring in the real world are heterogeneous. In almost every analysis, a representative sample of the solid material must be taken in order to attain a satisfactory answer of its composition. The proper sampling of such materials represents an area of great importance in analytical chemistry. Obtaining a non-representative sample initially can negate the analytical results obtained later, no matter how careful the experimental work is performed. As shown in **Figure 4.1**, how does one represent a large, non-uniform whole with a small solid sample needed for analysis? There are two approaches: 1) take minute quantities of the solid material and blend them to represent the whole, or 2) take a quantity of material large enough to be compositionally representative and reduce it to a fine homogeneous powder. In the first case, it is statistically difficult to obtain a representative sample since so many small samples must be taken to get an adequate representation of the whole material that the time required would take too long. The second approach is most often used to obtain a representative sample. During a mass-reduction stage, every particle in the sample before mass-reduction should have an equal probability of being included in the sub-sample retained after mass-reduction. A defined sampling plan is important to ensure the best possible sample of the original lot. The various techniques for particle size mass-reduction of solid materials will be covered in this section.

Figure 4.1

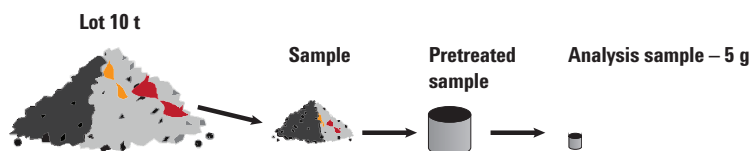

The final sample used for analysis must be representative of the original lot



# Particle Size Reduction

It is usually desirable to render solid samples into a finely divided state for the following reasons:

- Finely divided samples are more homogeneous, allowing more representative sub-sampling with greater precision and accuracy if carefully mixed.
- Finely divided samples dissolve faster and are easier to extract because of their greater surface area.

General methods for reducing the particle size or grinding of solid samples are outlined in **Table 4.1**. Sometimes, depending on the particle size, a coarse reduction may be required initially, followed by a fine particle size reduction. For example, chopping a bunch of carrots into sufficiently small pieces to place into a laboratory blender where they are reduced to a finely-divided, semi-solid is a simplistic approach for the particle size reduction of soft samples. As the material gets harder and the initial particle size gets larger, approaches that are more drastic are required. Laboratory crushers, mills, pulverizers, and grinders are more appropriate for these samples. The choice of device is determined by the following parameters:

- Type of material based on its hardness (Moh number for hard materials or degree of softness for samples such as tissue, plastics, plant material, paper, leather, etc.)
- Initial particle size (e.g., chunks or powder)
- Final desired particle size (e.g., mm or micrometer)
- Sample quantity or throughput required
- What contamination may interfere with the subsequent analysis

Table 4.1.

<b>Methods for Reducing Sample Particle Size of Solids</b>	
<b>Particle Size Reduction Method</b>	<b>Description of How Sample Reduction is Performed</b>
Blending	A mechanical blender is used to chop a semi-soft substance into smaller parts; can also refer to the process of blending a heterogeneous sample into a more consistent and uniform sample.
Chopping	Process of mechanically cutting a sample into smaller parts.
Crushing*	Tungsten-carbide variable-jaw crushers can reduce large, hard samples to smaller diameter particles.
Cutting	Cutting mills can reduce soft-to-medium hard materials (<100 $\mu\text{m}$ diameters).
Grinding*	Manual and automated mortar and pestles are the most popular; both wet and dry grinding are used; particles of approximately 10 $\mu\text{m}$ diameters can be achieved.
Homogenizing	Process of making a sample more uniform in texture and consistency by breaking down into smaller parts and blending.
Macerating	The process of breaking down a soft material into smaller parts by tearing, chopping, cutting, etc.
Milling*	Disk mills pulverize <20 mm diameter hard samples by feeding between stationary and rotating disks with adjustable gap settings; generally reduced to 100 $\mu\text{m}$ in diameter. Rotor-speed mills combine impact and shearing processes to grind soft-to-medium hard and fibrous materials down to 80 $\mu\text{m}$ ; balls mills grind material to sub- $\mu\text{m}$ fineness by developing high grinding energy via centrifugal or planetary actions using agate, tungsten carbide, or PTFE-coated stainless steel balls; a soil mill will gently pulverize dried samples of soils, sludges, clays, and similar material by rotating nylon brushes throwing a sample against a chamber wall.
Mincing	The process of breaking down a meat or vegetable product into smaller parts by tearing, chopping, cutting, dicing, etc.
Pressing	Generally, the process of squeezing liquid from a semi-solid material (e.g. plants, fruit, meat).
Pulverizing*	Electromechanically-driven rod or vibrating bases used to reduce particle size of wet or dry samples; freezer mill can be used with liquid $\text{N}_2$ to treat malleable samples or those with low glass transition temperatures.
Sieving	Process of passing a sample through a metal or plastic mesh of a uniform cross-sectional area (square openings from 3-123 $\mu\text{m}$ ) in order to separate particles into uniform sizes; both wet and dry sieving can be used.

\*The mechanical devices generate a considerable amount of heat and high shear forces that may be detrimental to the integrity of certain samples, such as polymers, which may undergo molecular weight degradation.

Another choice is whether the sample must be reduced continuously or in batches. Of course, this choice is somewhat dependent on the size of the initial sample, but there are cases where downstream continuous analytical measurement dictates continuous particle size reduction. Most size reduction techniques are performed in a dry state, but for certain samples, such as those that tend to agglomerate during grinding or may change their crystalline structure due to heating effect, wet (or slurry) grinding is an alternative. Here, the particle size reduction is carried out in the presence of water or other liquid. Obviously, to use wet grinding, the presence of liquid must not cause any chemical or physical-chemical alterations to the sample. Wet grinding is generally less convenient and more time-consuming than dry grinding and requires leak-proof grinding containers. Sometimes other additives aid the grinding process such as dry soaps, detergents, and graphite. Even special blends of an abrasive, lubricant, and binding agent are available as grinding aids for specialized applications.

Since all particle size reduction involves some sort of abrasion, contamination by the grinding tools is always a constant threat. Selection of a suitable set of grinding materials – with surfaces that are of similar composition to the sample or constructed with materials that will not interfere with the analysis – is an important decision that must be made. Typical materials that make up particle size reduction tools include stainless steel, tungsten carbide, agate, sintered alumina, hard porcelain, and zirconia. Obviously, choice of a tool with a surface hardness greater than that of the sample is desired and will minimize sample contamination. The abrasion resistance of grinding tools is important for wear. Grinding without losses of even minute amounts of sample is not possible because some of the material adheres to the grinding surface. This material is lost during the cleaning process unless the grinding surface is cleaned and washed after grinding and the solid particles suspended in the washing liquid are recovered.

Details on equipment available for reduction of particle size is beyond the scope of this section. Readers are referred to literature on the subject<sup>1-3</sup> as well as manufacturer's literature. Companies active in this area include Retsch Technology (Haan, Germany), Spex SamplePrep (Metuchen, NJ, USA), Fritsch (Idar-Oberstein, Germany), and Buehler (Lake Bluff, IL, USA), among others.

## Practical Aspects of Particle Size Reduction

If the sample contains thermally labile or volatile compounds, it is important to minimize heating during the grinding process. Sometimes, to keep the sample cool during grinding, dry ice can be added directly to a mortar or ball mill. Note that the dry ice should be prepared from carbon dioxide that is free from impurities that might contaminate the sample. Some ball mills can be fitted with a cooling block to permit the circulation of cool liquid during grinding. As mentioned earlier, when lower temperatures are required to solidify the sample, pulverizing the sample under liquid nitrogen can be carried out in a freezer mill. The material may then be sieved to further break it up and achieve a more homogeneous sample.

For air-sensitive samples, some grinding mills can be fitted with an enclosure that permits the introduction of inert gases during the grinding cycle. There are mills where the grinding process can be carried out in a vacuum, if the material warrants this condition.

Equipment that is built to crush rocks and other hard samples must have large motors and use mechanical advantage with rotating blades, rotors, wheels, belts, and gears to accomplish their task. Therefore, they always represent a safety hazard and one must be very careful, especially when loading sample into the feed hopper. Manufacturers have tried to build safe products that minimize operator exposure to hazardous conditions. Most doors and lids have safety interlocks and safety switches are installed to prevent accidental startup if they have been left open or are opened during operation. Centrifugal devices usually have a built-in electronic brake to slow down the rotor once the unit is turned off. Grinding jars/bowls and their holders are often held in place with clamps to prevent their coming loose during the grinding process.

Dust is another possible hazard. Since grinding and pulverizing generates micron and sub-micron fragments, this material might get into the air. Micron-sized particles are especially hazardous since they can easily be breathed in and can lodge in the lungs. Often, manufacturers have built protection devices such as traps, filter tubes, and covers over the areas of suspected dust generation. It is also important to prevent the loss of small particles on the surfaces of the tools used for grinding, pulverizing, etc. To recover such fines, some rinsing of the surface may be required.

When using laboratory crushers, mills, pulverizers, and grinders for hard materials, ensure that the sample is fed in small amounts rather than all at once to prevent overloading the drive motor. To prevent damage, most modern particle size reduction equipment has overload protection circuits.

## Secondary Sampling and Sample Size Reduction

Once the samples have been ground and mixed, there may be reasons to further sub-divide them for testing, evaluation, or analytical purposes. To do this, ensure that the sample portions maintain the same sample integrity as the original. Once particle size reduction has taken place, another problem arises. Although particle sizes are relatively uniform, there may be far too much sample. We may have arrived at this point by the processes described in the previous section. Whatever the source and history of our laboratory sample, the common problem is that there may be tens-, hundreds-, maybe even thousands of grams of sample. Depending on the analytical technique, only tenths of a gram to grams can be analyzed, further sample size reduction must occur.

Sample size reduction is sometimes referred to as division. As already stated, truly representative sampling for analysis has long been recognized as fundamental to the production of accurate and useful information. Understanding the importance of this step is essential when attempting to perform any statistical analyses of a sampling and analysis procedure. Of course, few of us will become involved in detailed statistical analyses of complex distributions of materials, but in the event that this does arise, references 1-3 provide a good starting point. The challenge is to divide the sample without discrimination with respect to size, density, or any other characteristic of the particles.

Coning and quartering is one of the oldest methods for sample size reduction. As depicted in **Figure 4.2**, the finely-divided solid is poured onto a clean flat surface (plastic sheet) from a fixed position and a cone of material forms in the middle while particles fall away to each side, hopefully without bias. A quartering device is then applied to the highest point of the cone and pushed down through it to the flat surface below:

Figure 4.2

### Coning and Quartering

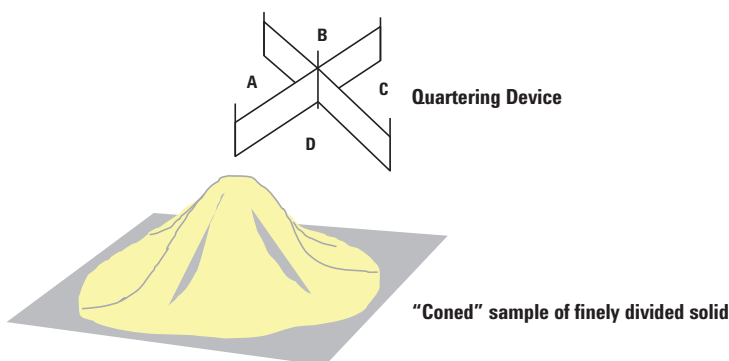

When the quartering device has been applied, again to avoid bias, diagonal sectors are retained (A and C, for example) and the sectors between (B and D) are discarded. Portions A and C are combined and the coning and quartering process is repeated, often several times, until a sufficient sample for the final analysis is obtained.

There is a very wide range of other mechanical constructs that have been devised to overcome the problems associated with sample size reduction. The most popular types of devices are called rifflers. Riffling involves the separation of free-flowing sample into equal parts using a mechanical device composed of diverter chutes. The simplest of these devices is the stationary riffle, but more complicated devices are available. Both coning/quartering and riffling approaches are effective but laborious. Therefore, automated laboratory sample dividers (e.g. proportional dividers such as straight-line samplers or spinning riffle sample dividers) have been developed to divide granular powders into samples of identical quality and quantity. These laboratory dividers accomplish the process by repeated dividing and pouring together. In this way, each particle in the sample is given an equal chance at arriving in any collecting channel and the sample is truly divided. For further reading on these devices, consult references 1-3 and manufacturers' literature.

## Further Particle Size Reduction and Classification

Once a sample is crushed and ground into smaller particles, it may be necessary to further classify the particles in the ground sample. The most popular devices for particle sizing are mechanical sieves, which are classified by mesh size or size of the square openings in millimeters. The particles are separated by using a series of sieves of known but differing mesh numbers. The mesh number of a sieve determines the diameter of the holes in the sieve. A higher mesh number indicates a smaller diameter or finer sieve. If your entire sample passes through a sieve with a particular mesh number, then you know for certain that you have no particles larger than the diameter defined by that mesh number. If you are attempting to obtain particles of a particular mesh size and the particles do not pass through a sieve of larger mesh size, you must regrind the sample until it passes. Standard sieves are of metallic construction – all brass, stainless steel screen/brass frame, and all stainless steel – are round, but come in different diameters. High tolerance, precision electroformed sieves are preferred, but much more expensive than the standard sieves. Non-metallic sieves (e.g. nylon) that contribute no metallic impurities are also available.

Both dry sieving and wet sieving may be carried out. Water-jet sieving devices, where the water is forced into each individual sieve in a stack, provides a rapid fractionation using standard testing sieves. For the tiniest particles down to 5  $\mu\text{m}$ , wet sieving, using water or solvent, can be performed in an ultrasonic sieving apparatus that is quite efficient for gentle fractionation of particulates without further crushing. Automated sieve shakers simplify the sieving process and a wide variety is commercially available.



## Sampling Error, Sampling Fraction, and Particle Size

The final key to sampling is getting a representative sample after particle size reduction. But how do we know if we have analyzed a representative sample? The only sure way to know the answer to this is to take a large number of samples, do the multiple analyses and find that – within experimental error, or some acceptable level of statistical significance – the same answer is obtained each time. Sometimes we will be forced to do this, but usually this course of action is too exhaustive, time-consuming, and expensive.

As a guide to the overall outcome of our sampling effectiveness, make sure that we are operating within the limits that are acceptable to us. **Figure 4.3**<sup>4-5</sup> provides the quantitative guidance that we need.

The first thing that **Figure 4.3** conveys is common sense, but the process is very inconvenient. The solid lines that correspond to the percentages of the original material sampled for analysis make it clear that the more sample we take, the smaller the sampling error will be. Since we cannot work with kilograms, many grams – even hundreds of grams – for analysis, we are stuck on the 1.0% line at best, and probably on the 0.1% line or worse. Therefore, we must follow the lines down to the right; that is, grind the sample up as finely as possible to maximize the number of particles and minimize the sampling error for a fixed percentage taken. But how fine is ‘as finely as possible’? To know where we are on **Figure 4.3**, we must know the particle size. Ideally, we must either measure it, or have someone determine it for us. Alternatively, the manufacturers of your particle size reduction device may be able to point you to data appropriate to your sample and procedure. With the particle size known, the number of particles may be estimated and we have a fix on the abscissa of **Figure 4.3**. Then it is necessary to decide on the tolerable sampling error and get our ‘y coordinate’. The percentage of the sample to take is then known.

Obviously, compromises will often need to be made. We may need to go up by a factor of 2-3 in analytical scale if the sampling error is unacceptably large for the minimum particle size (maximum number of particles) we are able to generate. Alternatively, for the solution to a long term problem, investment in a different particle size reduction device may be necessary. Or, perhaps a second stage of particle size reduction is justified; e.g., grinding after crushing. Data of the kind in **Figure 4.3** allows us to understand the limitations of the sample size reduction process and to be in control of the outcome.

**Figure 4.3**  
**Percentage sampled, number of particles and sampling error <sup>4</sup>**

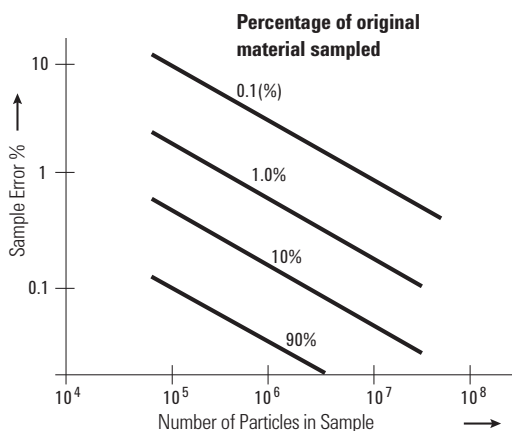

## Drying the Solid Sample

Solid samples are often received for analysis in a damp or wet state. Removal of water and/or drying the sample to constant weight is usually necessary for a reliable assay. Inorganic samples such as soil should be heated at 100-110 °C to ensure the removal of moisture. Hydrophobic organic samples seldom require heating, since water absorption is minimal. However, organic vapors also can be adsorbed by solid organic samples, and a heating step can remove these contaminants. For hygroscopic or reactive samples (e.g., acid anhydrides), drying in a vacuum desiccator is recommended. Samples that can oxidize when heated in the presence of air should be dried under vacuum or nitrogen. Biological samples generally should not be heated to >100 °C, and temperatures above ambient should be avoided to avoid sample decomposition. Sensitive biological compounds (e.g., enzymes) are often prepared in a cold room at <4 °C to minimize decomposition. Such samples should be maintained at these low temperatures until the HPLC analysis step. Freeze drying (lyophilization) is often used to preserve the integrity of heat-sensitive samples (especially biologicals). Lyophilization is performed by quick-freezing the sample, followed by removal of frozen water by sublimation under vacuum.

### References

---

1. Rhodes, M. (Ed.) *Introduction to Particle Technology*, 2nd Ed., John Wiley and Son, Chichester, U.K., **2008**, ISBN-978-0-470-01427-1 and ISBN-978-0-470-01428-8.
2. Bhatt, B.; Agrawal, S.S. *Size Reduction and Size Separation, Pharmaceutical Engineering, NISCAIR National Science Digital Library* **2008**, URL: <http://nsdl.niscair.res.in/handle/123456789/750/revise+size+reduction.pdf>.
3. Chen, B.; Nottingham, J.; Anderson, B.C. *Particle Size Reduction Studies on the Lab and Commercial Scale Using High and Low Energy Mills, American Pharmaceutical Review* **April 2012**, *15* (3).
4. Cross, R.F. *LCGC No. America* **2000**, *18* (5), pp 468-476.
5. Hodges, R.J. *Analytical Sample Preparation – Problems for the Chemist*, presented to the Analytical Chemistry Group, Royal Australian Chemistry Institute, Melbourne, **June 1978**.

# Filtration

Particulates should be removed from liquid samples prior to injection because of their adverse effect on column lifetime. In addition, particulates can also affect HPLC hardware (e.g. flow lines, rotary injection valves, and inlet frits) and GC inlets, columns, and detectors. The most common methods for removing particulates from the sample are filtration, centrifugation, and sedimentation. Approaches to filtration are given in **Table 5.1**.

**Table 5.1**

Filtration Media	Typical Products	Recommended Use	Comments
Filter Paper	Cellulose	For removal of larger particles (>40 $\mu\text{m}$ )	Beware of filter paper fibers getting into sample; ensure solvent compatibility of filter paper.
Membrane Filters	Regenerated cellulose, cellulose acetate, nylon, PTFE, polypropylene, polyester, polyethersulfone, polycarbonate, polyvinylpyrrolidone	For removal of small particles (>10 $\mu\text{m}$ )	For "dirty" samples, prefilter or depth filter may be needed to prevent plugging; porosities from 0.20 to 2 $\mu\text{m}$ are the most popular; avoid solvent incompatibility.
Functionalized Membranes	Ion exchange membranes, affinity membranes	Can remove both particulates and matrix interferences	For "dirty" samples, prefilter or depth filter may be needed to prevent plugging; avoid solvent incompatibility; primary goal is for removal of biomolecules from solution.
SPE Cartridges	Silica- and polymer-based		Particles of stationary phase may pass into filtrate; use only high-purity products with low extractables; beware of plugging.
SPE Disks	PTFE- and fiberglass-based		PTFE membranes are delicate, so handle with care; fiberglass disks are more structurally rigid; can pass large volume at higher flow rate than with cartridges; beware of plugging.

Paper filtration (**Figure 5.1A**) is a relatively straightforward technique where a semi-permeable paper barrier is placed perpendicular to the flow of liquid (and sometimes gas). In laboratories, filter paper is usually placed in a filter funnel, Hirsch, or Buchner funnel. Paper filters come in a variety of diameters, shapes, and porosities. The lower the porosity of the filter medium, the cleaner the filtrate, but the longer the filtering time. Vacuum filtration speeds up this process. Fluted filter paper (**Figure 5.1B**) allows for faster flow since the wet paper is not pressed against the walls of a filter funnel. Filter paper can be pretreated depending on its ultimate application. For example, for quantitative gravimetric analysis, ashless filter paper is used; for base-sensitive samples, acid-washed filter paper can be purchased.

Figure 5.1

## Popular Types of Filters for Particulate Removal

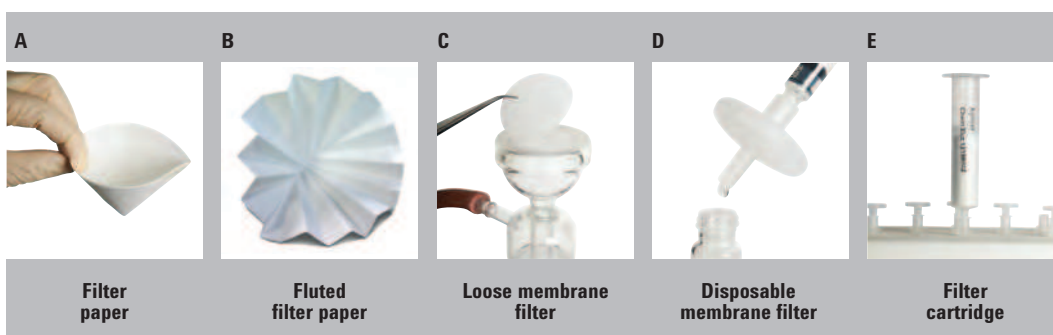

Membrane filters (**Figure 5.1C**) in a disk format can be purchased loose for placement into commercial filter holders/housings. However, most users prefer disposable syringe filters (**Figure 5.1D**) equipped with Luer or mini-tip fittings. The filter bodies are usually constructed with medical-grade polypropylene or polycarbonate housings, sterilized with gamma radiation, and are designed with low extractables in mind. Some premium syringe filters are even batch-tested by LC or LC/MS and are certified for highest purity. The last type of filter (**Figure 5.1E**) is the filter cartridge. Here, the membrane filter is placed at the base of a syringe barrel and the setup resembles the popular solid phase extraction devices (see Chapter 9).

To use a syringe filter, the liquid sample is placed in a syringe and filtered through the membrane using gentle pressure. A variety of membrane materials, nominal porosities and dimensions are available, and the manufacturers' literature provides specifications. Filter types should be selected based on sample volume, sample solvent, and size of particulates to be removed.

The large cross-sectional areas of the membrane disk type of filters allow for good flow characteristics and minimal plugging (see **Table 5.2**). Typically, for larger volumes of sample (up to 50 mL), membrane filters with a diameter of 30 mm are sufficient. The holdup volume (filtrate volume that may be lost during use) is only 50  $\mu\text{L}$ . For smaller volumes (up to 30 mL), a 25 mm filter with a moderate cross-sectional area (3.5  $\text{cm}^2$ ) and less than 50  $\mu\text{L}$  holdup volume should work. For even smaller volumes (up to 10 mL), the 13 mm diameter membrane filters with holdup volume of less than 10  $\mu\text{L}$  are highly recommended and represent the best compromise between sample volume and holdup volume. For those that have the least amount of sample (less than 1 mL), 3 mm filters are available.

Table 5.2

Diameter [mm]	Sample Volume [mL]	Hold Up Volume [μL]	Effective Filter Area [cm <sup>2</sup> ]
30	1-50	<50	5.1
25	1-30	<30	3.5
13	1-10	<10	0.75
3	<1	<7	0.0

For most samples encountered in HPLC and ion chromatography, filters in the range of 0.20-2 μm nominal porosity are recommended. The porosity values are approximate and the type of membrane can have some influence on the filtration range. The most popular for sample filtration are the 0.20 and 0.45 μm porosities. Membranes with 0.20 μm pores remove the tiniest of particulates (and large macromolecules). If the sample contains colloidal material or a large amount of fines, considerable pressure may be required to force the liquid sample through the filter. Sometimes, for these types of samples such as soil extracts or wastewater, a prefilter or depth filter bed is placed on top of the membrane to prevent plugging with samples containing these types of particulates. These dual-layer filters are sometimes called 2-in-1 filters.

Typical high recovery membrane filters for use with most common solvents include regenerated cellulose (RA), cellulose acetate (CA), cellulose nitrate, PTFE, and nylon. Regenerated cellulose is a universal filter because it can be used effectively with both aqueous and organic sample solvents. It is also a good choice for polynuclear aromatic hydrocarbons (PAHs) and aqueous bio-samples. Moreover, membrane filters such as regenerated cellulose and cellulose acetate provide the best sample performance and lowest protein adsorption, giving excellent high sample recoveries for proteins in biological samples.

For biological samples, the spin filter format is quite popular. These filters consist of polypropylene centrifuge tubes with cellulose acetate filter membranes that are used to remove particulate matter from samples such as serum, plasma, or protein samples diluted in aqueous buffers through low-speed centrifugation (maximum 16,000 x g gravity).

An important consideration in membrane filter selection is the solvent compatibility with the membrane. Manufacturers of membrane filters usually provide detailed information and tables on solvent compatibility of their products (see **Table 5.3** for a typical compatibility chart). If an inappropriate solvent is used, the filter may dissolve (or soften) and the filtrate becomes contaminated.

Table 5.3

Chemical Resistance Table for Membrane Filters					
Substances	Cellulose nitrate	Cellulose acetate	Regenerated cellulose	Nylon 66	PTFE
1-Hexanol	+	+	+	+	+
1,4-Dioxan	--	--	+	na	0
Acetic acid, 10% & 25%	+	0	+	--	+
Acetone	--	--	+	+	+
Acetonitrile	--	--	+	+	--
Aliphatic hydrocarbons	+	+	+	+	+
Ammonia, 1 M	+	+	+	+	+
Aromatic hydrocarbons	+	+	+	na	+
Benzene	+	+	+	+	+
Boric acid	+	+	0	0	+
Carbon tetrachloride	+	0	+	--	+
Carboxylic acid	+	+	+	--	+
Chloroacetic acid	--	--	0	--	+
Chloroform	+	0	+	+	0
Cyclohexane	0	0	+	+	+
Cyclohexanol	+	+	+	+	+
Diethylether	0	0	+	+	0
Dimethyl formamide	--	--	0	+	+
Dimethyl sulfoxide	--	--	0	na	+
Ethanol = or < 98%	--	+	+	+	+
Ethyl acetate	--	--	+	+	+
Ethyl chloride	0	0	+	+	+
Ethylene glycol	0	+	+	+	+
Formic acid, 25%	+	0	+	--	+
Hexane	+	+	+	+	+
Hydrochloric acid, 25%	+	+	+	--	+
i-Propanol	+	+	+	+	+
Methanol	--	+	+	0	+
Nitric acid, 25%	0	0	+	--	+
Pentane	+	+	+	+	+
Phosphoric acid, 25%	+	+	+	0	+
Phosphoric acid, 45%	0	0	0	0	+
Potassium hydroxide, 1 M	--	--	0	--	+
Salt solutions, aqueous	+	+	+	+	0
Sodium hydroxide, 1 M	--	0	--	--	+
Tetrachloroethane	+	0	+	0	+
Tetrahydrofuran	--	--	+	+	0
Toluene	+	+	+	+	+
Trichloroacetic acid, 10%	+	--	--	0	+
Trichloroethane	+	0	+	0	+
Trichloroethylene	0	0	0	0	0
Xylene	+	+	+	+	+

**Key**

+ = Resistance                      -- = Not resistant  
 0 = Limited resistance            na = Not available

Although their main purpose is not for sample filtration, the more expensive, functionalized membranes and solid phase extraction (SPE) disks and cartridges are not only used for chemical interference removal, but also serve to remove particulates.

For automation, particularly in high-throughput laboratories, a popular format is the 96-well flow-through filtration plate (see **Figure 5.2**). Basically, this format, usually of polypropylene construction, provides an 8 x 12 array of small membrane filters. Samples are usually loaded with a multi-pipette capable of handling a minimum of eight wells at a time. For very high-throughput situations, 96-pipette capability is available for the simultaneous loading of samples by an automated x-y-z liquid handling station. With the 96-well filtration plates, various membranes are also available in various porosities. For example, Agilent Technologies Captiva 96-well plate filter materials are polypropylene (0.2, 0.45, and 20  $\mu\text{m}$  porosity), polyvinylidene fluoride (PVDF), and glass fiber (10  $\mu\text{m}$ ). A particularly useful 96-well plate for removal of proteins and lipophilic substances from plasma is the Captiva ND<sup>Lipids</sup>, where ND stands for the non-drip membrane configuration. For more information on this plate, see Chapter 16.

When processing larger volumes of sample, or when an automation system is not available, Captiva filter cartridges (tubes) (see **Figure 5.1E**) are available with the same functionality of the Captiva 96-well plates, but in a standard SPE cartridge format. The 3 mL volume depth filter cartridges are available with 0.2  $\mu\text{m}$  and 0.45  $\mu\text{m}$  porosity membrane filters. A particularly useful cartridge filter design for clarifying highly particle laden samples, such as freshly thawed plasma, is the Captiva 10  $\mu\text{m}$  glass fiber filter cartridge. Such a design prevents sample transfer problems due to pipette tip clogging.

## Figure 5.2

### Captiva 96-well filtration plate mounted on vacuum manifold



The filter vial, a unique syringeless membrane filter, capable of handling 0.4-1.0 mL of sample, is pictured in **Figure 5.3A**. It is a preassembled filtration device that replaces the combination of syringe filter, syringe, autosampler vial, septum and cap with a single disposable unit. Filter vials consist of two main sections: a chamber and a plunger. The plunger design incorporates a filtration membrane on the bottom end and a pre-attached cap with a septum on the top end. The unfiltered liquid is placed in the chamber (bottom section) (**Figure 5.3B**) and, once the sample is added, the plunger is fitted into the chamber (**Figure 5.3C**). By pressing the plunger through the liquid in the chamber, the positive pressure on the plunger assembly forces the clean filtrate up into the reservoir of the plunger (**Figure 5.3D**). Air escapes through the vent hole until the evaporation seal is engaged, providing an airtight seal. The filter vial can then be placed into any autosampler carousel that accommodates 12 x 32 mm vials for automated injection into the instrument. The membranes include: PTFE, Polypropylene, Nylon, PES, Regenerated Cellulose, Cellulose Acetate, and additional depth filters for highly particulate laden samples.

Figure 5.3  
**Filter Vial in Use**

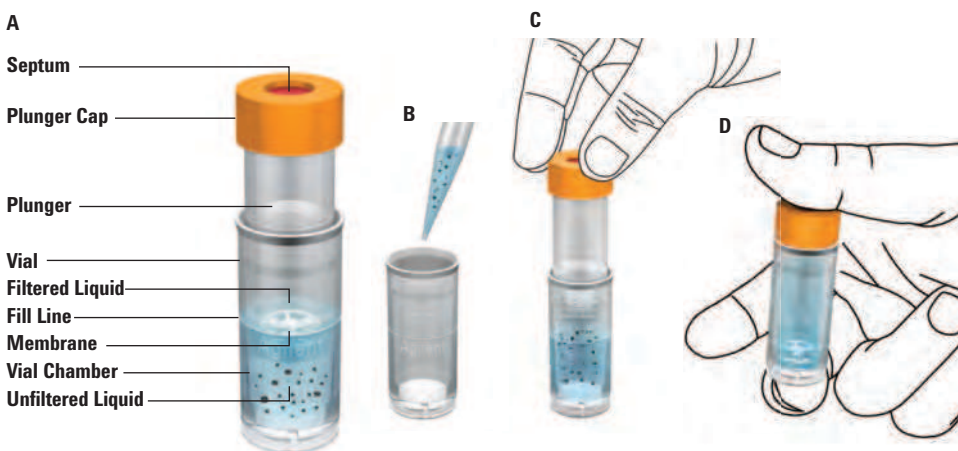



# Sample Introduction and Sample Preparation of Volatile Organic Compounds

Gaseous samples comprise a great number of the samples encountered in typical gas chromatography analyses. Volatile organics are among the compounds most often analyzed in the petroleum, petrochemical, food, flavor and fragrances, and environmental segments. In this chapter, an overview is provided of the methods that are used to collect and prepare such samples for introduction into the gas chromatographic instrument and occasionally into HPLC systems.

One can divide front end of the analysis of volatile samples into sampling (sample collection) techniques, sample preparation techniques, and sample introduction (injection) techniques. It is useful to distinguish between these three areas of sample handling prior to analysis. As discussed earlier in Chapter 3, sampling is not only the act of obtaining the sample, but preserving its integrity prior to sample introduction or sample preparation. For example, capturing a volatile sample by use of an impinger or metal canister would be a sample collection step. In this chapter, sampling techniques will be briefly covered. Sample introduction is the process of introducing the sample directly into the GC without any prior treatment. For example, the direct injection of a gas into the injection port of the GC would be a sample introduction process. Similarly, for a liquid sample, if a large injection volume was used via a programmed temperature vaporizing (PTV) inlet, this would be considered a sample introduction technique. Sampling of the headspace above a solid sample with a syringe with a direct injection into the GC, likewise, would be a sample introduction procedure. A sample preparation procedure would be a modification or treatment of the sample prior to sample introduction for the purpose of improving the introduction process into the GC. For example, performing a dynamic headspace process with an intermediate cold adsorbent trap to concentrate the analyte(s) of interest prior to sample introduction into the GC would constitute a sample preparation procedure. Derivatizing an adsorbed polar compound on a solid material, thereby releasing it into vapor phase for subsequent sampling, would be a sample preparation process. Whatever you call it, it is most important that the components of interest be transferred from the point of collection to the GC column without being lost or modified.

In Chapter 2, **Table 2.1** provided an overview of the most popular sampling and sample preparation methodologies used in GC laboratories. Sometimes these techniques are used in combination. For example, dynamic headspace is a combination of headspace sampling and adsorbent trapping where a gas is used to sweep the headspace of a solid or liquid sample to concentrate volatile analytes on a solid sorbent that is eventually heated to thermally desorb the analytes into the GC column. Solid phase microextraction (SPME) may be used to sample a headspace with subsequent thermal desorption of the analyte(s) in the injection port of a GC.

The remainder of this chapter will be devoted to the sample and introduction techniques for volatile organic compounds (VOCs). Semi-volatile organic compounds can also be handled by several of the techniques discussed in this Chapter, but can also be prepared using those techniques (e.g. liquid-liquid extraction, SPE, etc.) covered throughout this handbook.

## Sample Inlet Systems for Gas Chromatography

There are entire chapters of books<sup>1-3</sup> devoted to detailed discussions about the various inlet systems in gas chromatography. Only the highlights will be reviewed here. The most common method of introducing liquid samples into a gas chromatographic inlet is by means of a microsyringe through a self-sealing rubber septum. Gas-tight syringes are also available for injecting gases and vapors, but, in general, gas sample valves are more reproducible and are often preferred. Using a loop or a fixed internal volume, gas sampling valves can also provide a convenient method of automation or when directly analyzing gaseous streams. In all cases, the objective is to get the volatile sample into the column rapidly and in as small a volume as possible.

In GC, there are two general classes of inlets: 1) hot or vaporizing inlets or 2) cold, cool inlets. The temperature of hot inlets is generally 50 °C above boiling point of the sample solvent; while cold inlets are below the boiling point of the solvent perhaps at room temperature, or even below, to condense the sample followed by heating to completely evaporate the sample during the run. Hot inlets immediately vaporize the sample so that it quickly gets to the column entrance. Too high of a temperature, however, may degrade the sample and too big of the sample volume may generate too much vapor and overload the finite volume of the inlet system. Flashback is a phenomenon where these excess vapors may reach the top of the inlet and condense on the cool septum, back diffuse into carrier gas lines, and condense on cool services, or exit through the septum purge line, leading to undesirable sample introduction effects.

Cool inlets minimize sample degradation and sample discrimination since all the sample enters the inlet at low temperature. **Table 6.1** provides a comparison of the different types of inlets used in gas chromatography. The most popular capillary column inlet is the split/splitless inlet. It can be used in the split mode to reduce the amount of sample reaching the column and produces very narrow initial peak widths. It can also be used in the splitless mode to maximize sensitivity. Split inlets are vaporizing inlets. The sample is evaporated in the inlet, flows down the liner, and is split between the column and a split vent. The “split ratio” (e.g., the amount of gas going into the column versus the amount of gas being vented through the split line) determines the amount of sample going onto the column. At high split vent flow rates, the sample is exposed to the high inlet temperature for a short period of time and is quickly introduced to the column.

Table 6.1

## GC Inlet Comparisons

Inlet	Advantages	Disadvantages
Packed-Column Direct	Vaporizing inlet, likely used with packed columns, easiest to use, least expensive	Not compatible with capillary columns (maybe 0.53 mm id), possible degradation of sample, possible needle discrimination
Split/Splitless: Split Mode	Simple, universal capillary column inlet, rugged, ideal for auxiliary samplers, protects column	Sample discrimination and sample degradation possible
Split/Splitless: Splitless Mode	High sensitivity capillary column inlet, protects column	Highest sample degradation and flashback, sample discrimination possible, requires optimization, maintenance required
Cool On-Column	Sample deposited directly into column (therefore high sensitivity), least sample discrimination, most inert	Sample overload possible, difficult to use with columns less than 0.25 mm id, complex to automate
Programmable Temperature Vaporization (PTV)	Cool injection, most flexibility, low sample degradation, high sensitivity	Complex, many parameters to optimize, most expensive, possible loss of volatiles (venting mode)

Adapted from Reference 1

In the splitless mode of injection, the split vent of the split/splitless inlet is turned off. Normally, the entire sample vapor enters the column, but due to the low flow rate in the capillary column, initial sample bandwidth is fairly broad. Usually, some form of sample focusing at the head of the column must be used.

The cool on-column inlet allows direct deposition of liquid sample into the column. Both the inlet and the column are below the boiling point of the solvent during the injection process. Then, both temperatures are increased to vaporize the sample and begin chromatography. Cool on-column inlets typically have a low thermal mass to facilitate fast heating and cooling at the end of the run. The challenge, of course, is to deposit the sample directly inside the small diameter capillary column. As might be expected, cool on-column injection is preferred for labile compounds in samples with a large boiling point range. Sample discrimination and decomposition is minimal. Because the sample is deposited directly into the column, sensitivity is quite high. Cool on-column inlets are used for the analysis of samples with a wide boiling-point range, or those that are thermally sensitive, and for trace analysis.

Programmable temperature vaporizing (PTV) inlets are a combination of split/splitless inlet and cool on-column inlet. They combine a cool injection inlet, temperature programming, and have a split/purge vent and a timer/controller unit. Non-volatile sample components are deposited in the inlet and do not migrate to the column; thus, dirty samples tend to cause less problems with PTV injections. During sample injection, the sample is deposited into a packed liner and the inlet temperature is raised, evaporating the solvent and sample components. When evaporated, the split vent is electronically controlled to be on or off, or some sequential combination of the two. Thus, the inlet allows a split or splitless injection in combination with temperature programming to optimize sample transfer, solvent venting, and sample discrimination based on boiling point, solute degradation, and ghosting during the run.

The PTV inlet was developed by Poy and co-workers<sup>4</sup>, based on the earlier work of Vogt<sup>5,6</sup>, who first described programmed temperature sample introduction. The sample was introduced into the inlet liner at a temperature slightly below the boiling point of the solvent. The low boiling solvent was continually evaporated and vented through the inlet split line. By introducing the sample at a low initial liner temperature, many of the disadvantages of the classical hot injection technique could be circumvented. For example, discrimination due to differences in boiling point is minimized by introducing the sample onto a "cool" liner and subsequently raising the temperature of the liner to the normal temperature of a conventional hot inlet. Compared to hot inlet injections, reduced thermal degradation of sensitive compounds occurs due to the slower heating.

To illustrate the principle of the PTV inlet, **Figure 6.1** provides a schematic drawing of the Agilent Multimode Inlet. As can be seen from this figure, the PTV inlet closely resembles the classical split/splitless inlet. The present design allows several injection mode possibilities: hot split/splitless, cold split/splitless (pulsed versions of these), Large Volume Injection (LVI)-solvent vent (an extension of cold splitless, see next section) with solvent vent timing. The programmable injection slows solvent evaporation and maximizes analyte transfer into the column. The carrier gas is connected through the septumless sampling head and enters the liner at the top. Temperature control on the liner is the key to the operation of the PTV inlet. The liner can be rapidly heated (heating coil) or cooled (peltier-, liquid nitrogen- or liquid carbon dioxide-cooling). In the injection mode, the sample is introduced by a variable-speed injector at a controlled speed and the inlet conditions are arranged so that the solvent is vented via the split line while the components of interest are trapped and preconcentrated.

Figure 6.1

## Schematic of Agilent Multimode Inlet

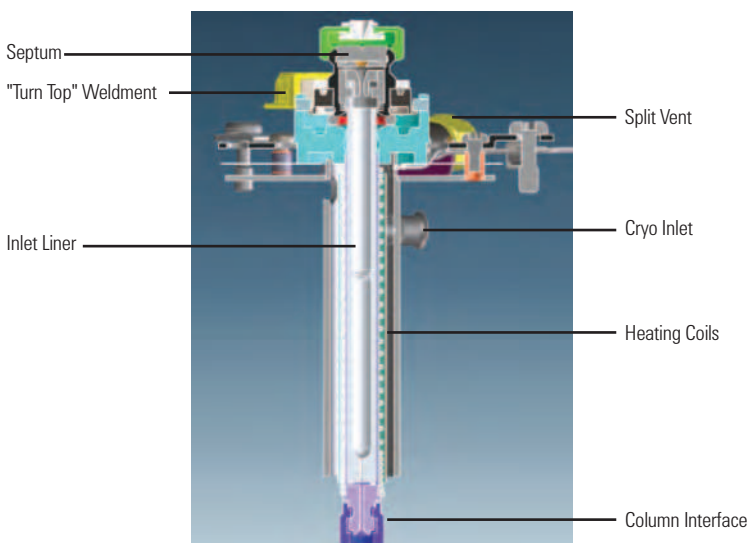

## Large Volume Injection (LVI) Techniques

The demand for lower detection limits is important in many areas of gas chromatography, particularly environmental, food, and biological analysis. Concentration of samples, by many of the techniques described in this book [e.g. liquid-liquid extraction (Chapter 7), solid phase extraction (Chapters 9-10), and pressurized fluid extraction (Chapter 14)] is one way of increasing method sensitivity by enriching analyte concentration. The development of improved and more selective GC detectors (e.g. electron capture detector, tandem mass spectrometry) is one approach in enhancing both selectivity and sensitivity. The lowering of the system background by providing more inert surfaces throughout the entire GC system can also provide lower limits of detection.

Detection limits can also be improved by injecting larger amounts of analyte solution into the GC injection port. However, typical capillary columns may only accommodate a few microliters at best. Injection principles such as "pulsed" splitless injection allow up to 5  $\mu\text{L}$  injections. Going beyond this injection volume can lead to system contamination, non-reproducible results, flashback, and sample loss.

Large volume injection (LVI) is an approach to lowering detection limits. With LVI, the bulk of the solvent is evaporated before transfer of the sample to the analytical column. There are two popular LVI techniques to eliminate solvent: programmed temperature vaporization (PTV) and cool on-column injection with solvent vapor exit (COC-SVE). Both lead to greatly improved detection limits and good chromatography with injection volumes of 500  $\mu\text{L}$  or more<sup>7</sup>.

The technique of PTV was discussed in the previous section. In some injector configurations, a controlled number of multiple injections from an autosampler can be used to provide a large sample to the column. To illustrate this approach, **Figure 6.2** provides an example of the use of multiple injections as a way of introducing larger sample volumes into the inlet<sup>8</sup>. Using a packed liner, 25  $\mu\text{L}$  of total sample containing pesticides was injected in five 5  $\mu\text{L}$  portions. Smaller portions ensure that a large volume of liquid does not run down the liner and enter the column, possibly causing overload, peak splitting, and possible damage to the stationary phase. **Figure 6.2** demonstrates that a good response is obtained from a 0.01 ppm mixture of pesticides.

In the PTV inlet, non-volatile sample components and degradation products remain behind in the inlet, minimizing column contamination. Thus, the PTV inlet is a good choice for dirty samples compared to the cool on-column and split/splitless inlets. It is not a good choice when the sample contains highly volatile analytes of interest since they may be vented with the solvent. A rule of thumb is that the compound should boil at least 100  $^{\circ}\text{C}$  above the solvent to be successfully handled with the PTV inlet.

With modern autosamplers, such as the Agilent 7693, fully programmable, controlled-speed liquid sample injection rate is now possible and is the preferred approach to perform multiple injections.

In COC-SVE, the COC inlet has a precolumn assembly consisting of a retention gap/precursor combination placed ahead of the analytical column. A vent line is attached at the juncture of the precolumn and analytical column as seen in **Figure 6.3**. Liquid sample is injected into the precolumn and the solvent evaporates and exits through the vent. Conditions are set that there is a small volume of solvent remaining in the precolumn. Sample components including volatiles are concentrated in this small volume of solvent. After evaporating the bulk of the solvent, the vent is closed and the normal oven temperature ramp is started. The remaining sample is then evaporated and transferred to the analytical column for separation. The entire process can be automated with most GC units.

Compared to the PTV inlet, with the COC-SVE there is an increased possibility to contaminate the precolumn since non-volatile compounds remain in the precolumn and may influence later separations. Thus, the precolumn may need more frequent replacement. This inlet is primarily used for trace analysis in clean matrices such as drinking water extracts. The COC-SVE inlet is useful for early eluting compounds and has minimal degradation of unstable components. Both the PTV inlet and the COC-SVE inlet show minimum sample discrimination.

Figure 6.2

## Large Volume Injection with Solvent Elimination PTV

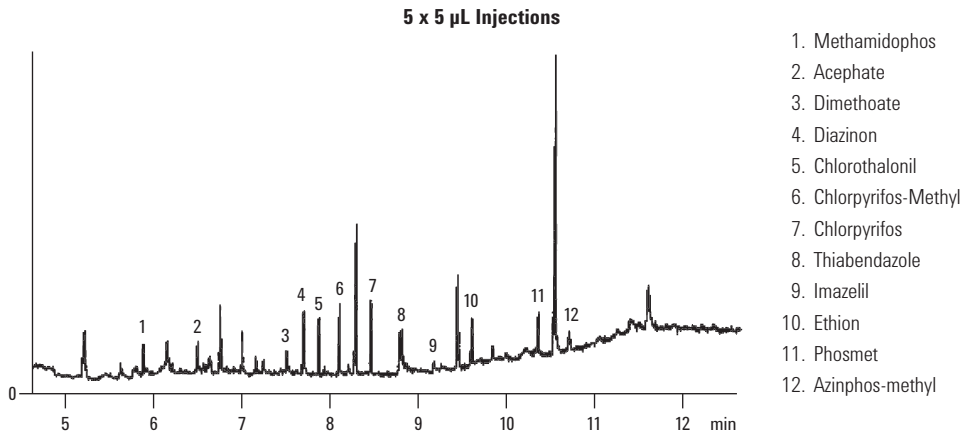

**Instrument:** HP 6890 with Electronic Pneumatics Control and PTV Inlet;  
 HP G1916A Automatic Liquid Sampler with HP G1513A Controller;  
 HP1707A Chemstation (ver.A.04.02)

**Pesticides:** 0.01 ppm

**PTV Conditions:**

Vent flow: 300 mL/min  
 Purge flow: 50 mL/min at 3.5 min (gas saver on at 4.7 min)  
 PTV initial temp: 20 °C  
 PTV initial time: 1.1 min  
 PTV rate: 700 °C/min  
 PTV final temp: 300 °C  
 Injection delay: 0.00 min  
 Injection volume: 25 µL (5 x 5 µL each)  
 Column: HP-5ms, 30 m x 0.25 mm x 0.25 µm

Figure 6.3

## COC Injection with SVE-Hardware Configuration

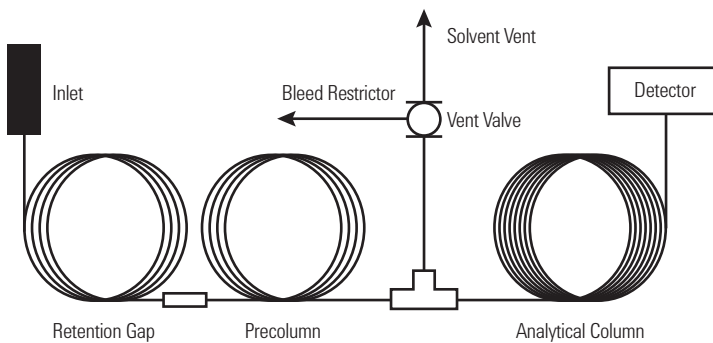

# Headspace Sampling Techniques

## Static Headspace

Headspace refers to the vapors that form over liquids and solids. If the sample is in thermodynamic equilibrium with the gas phase in a closed thermostated vessel, this method of analysis is referred to static headspace sampling. If an inert gas is passed through or over the sample and the stripped sample volatiles accumulated in an adsorbent trap or cryogenic trap, then the method is referred to as dynamic headspace or purge and trap. Since only the volatiles are sampled, headspace analysis is ideal for dirty samples (e.g. blood, plastics, cosmetics), solid materials, samples with high boilers of no interest, samples with high water content, or samples that are difficult to handle by conventional chromatographic methods. These matrices remain behind since only the volatile portion of the sample is in the headspace. In headspace sampling, calibrations are performed by preparing a solution of the analytes in a volatile solvent then injecting a small known amount into the closed headspace container so that the entire solution is vaporized.

Static headspace is basically a very simple sampling technique. The sample is placed in a glass vial of appropriate size that is closed with an inert septum. The vial is carefully thermostated until equilibrium is reached. A sample is taken either manually with a syringe or automatically with a headspace autosampler. Balanced-pressure headspace autosamplers have provision to pressurize the vial at a constant pressure equivalent to the column inlet pressure for better quantitation and an absence of baseline disturbance upon injection.

However, for valve and loop systems, such as the Agilent 7697, the pressurization option is not required nor always desired. A gas-sampling valve transfers the headspace sample to the GC instrument. With capillary columns, the sample volume injected must be limited with headspace samples just like injected liquid samples. Thus, flow splitting may be used to transfer a fraction of the sample. Cryogenic cooling is also a possible solution for larger headspace injection volume where thermal focusing will allow vapor concentration.



**Figure 6.4** illustrates a typical example of the use of headspace sampling for the analysis of blood alcohol. Blood is a difficult substance to work with and thus headspace sampling of a volatile analyte, such as ethanol, is a very convenient and simple-to-use method. In many countries of the world, an ethanol concentration of greater than 80 mg/100 mL of blood is considered to be the level of intoxication, while in some countries the allowable concentration is even lower. After headspace sampling in a 20 mL headspace vial using a headspace autosampler followed by GC analysis, the simple chromatogram in **Figure 6.4** shows the overlapped chromatograms of blank blood and ethanol-spiked blood<sup>9</sup>. The internal standard was t-butanol. A five-level calibration curve of ethanol standards showed excellent linearity over the concentration range of 10 mg/100 mL to 160 mg/100 mL. Over that concentration range, the repeatability was quite good: the average retention time %RSD was 0.03 while average peak area for ethanol gave a value of 4.6%.

Static headspace is simpler than the purge and trap method in that the headspace instruments are less complex, high concentrations of water in the sample do not affect the analysis as much, adsorbent traps are not required, there is no chance of breakthrough of volatile sample components, and repeated sampling can be done. Samples may be heated to increase the volatility of analytes. In aqueous solutions, the sensitivity can also be increased in some cases by adjusting the pH (shift equilibrium to undissociated form of an acidic or basic substance) or use salting out to increase the vapor pressure of analytes and reduce the solubility of the organic in water. For solid samples, increasing the surface area by grinding will increase diffusion of volatiles out of the matrix. For some samples, the addition of water will cause a competition for active sites and displace certain organics from the solid surfaces thereby raising their concentration of volatiles in the headspace. Sometimes, derivatization reactions are used for compounds containing reactive functional groups to generate more volatile compounds, which causes them to volatilize into the headspace. For example, the formation of methyl esters of carboxylic acids may release the acids from a solid material where they are tightly held by polar forces. For more detailed information on static headspace sampling for GC, see reference 10.

An interesting variation of the static headspace approach is the use of multiple extractions from the same vial using multiple headspace extraction (MHE) systems, which is similar but not synonymous with the purge and trap technique (see *Purge and Trap Sample Preparation*). The MHE approach is an absolute quantitative method used in static headspace GC. In principle, it is dynamic headspace extraction carried out stepwise and establishing equilibrium conditions in each step. The concentration of the analyte in the headspace decreases exponentially during the series of extraction steps; by proper mathematical extrapolation, the total peak area proportional to the total amount of analyte present in the original sample can be obtained. MHE is most often used to determine the amount of analyte present in a complex matrix where calibration standards in that given matrix are not feasible. Two examples, the determination of leachable compounds in packaging materials<sup>11</sup> and residual monomers in polymers<sup>12</sup>, illustrate the use of MHE in some actual samples. The reader is directed to references 13-15 for further information on this technique, including some of the mathematical calculations.

Figure 6.4

## Overlapped Headspace Chromatograms of Blank Blood Sample and Spiked Blood Sample

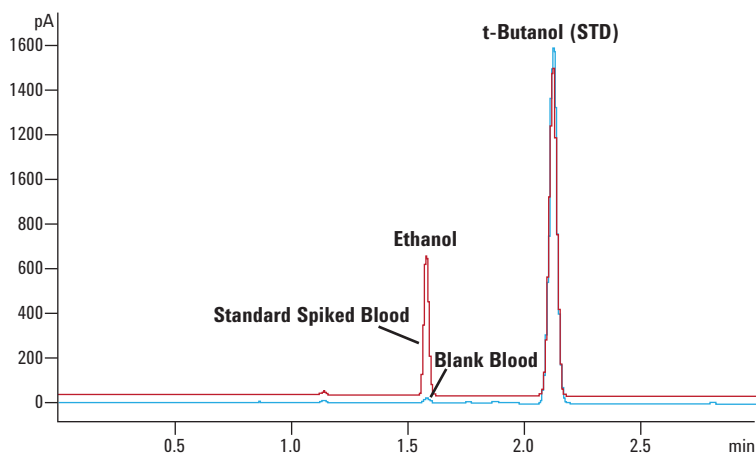

### GC Conditions:

Inlet settings: 200 °C, split ratio: 10:1  
Column: DB-ALC2 0.32 mm x 30 m,  
1.2  $\mu$ m (P/N 123-9234)  
Column flow (N<sub>2</sub>): 12 mL/min, constant flow  
Oven temp program: 40 °C (7 min)  
Temperature: 250 °C  
FID setting: H<sub>2</sub> flow: 40 mL/min  
Air flow: 400 mL/min  
Makeup (N<sub>2</sub>): 45 mL/min  
Data acquisition rate: 20 Hz

### Headspace Conditions:

Temperatures: Oven: 85 °C  
Loop: 85 °C  
Transfer line: 100 °C  
Times: GC cycle time: 15 min  
Press equil time: 0.1 min  
Vial equil time: 15 min  
Inject time: 0.5 min  
Vial: Fill mode: Flow-limited press  
Ramp rate: 20 psi/min  
Fill pressure: 15 psi  
Final pressure: 10 psi  
Fill flow: 50.00 mL/min  
Final hold: 0.05 min  
Fill mode: Advanced  
Vent after extraction: No

## Headspace Solid Phase Microextraction (HS-SPME)

In Chapter 10, the SPME technique will be explored in more detail, but an adaptation of the classical headspace experiment can be performed by its use, which will be covered here. SPME is a simple, solvent-free extraction technique that provides high sensitivity, excellent reproducibility, and low cost<sup>16,17</sup>. In this technique, a phase-coated fused silica fiber is exposed to the headspace above the liquid or solid sample. Analytes adsorb to the phase and then are thermally desorbed in the injection port of a gas chromatograph and transferred to a capillary column. In this technique, selectivity can be altered by changing the phase type or thickness according to the characteristics of the analytes. For example, the small distribution constants and low polarity of chlorinated and aromatic volatile organic compounds in environmental samples dictate the use of a thick, non-polar phase for efficient extraction. Multi-layer fibers are available for samples that contain a wide variety of analytes with varying distribution coefficients.

There are numerous examples of the use of SPME headspace sampling solving “real world” analytical problems. Investigators in a crime laboratory developed a simple, inexpensive, rapid, and sensitive method for analyzing gasoline in fire debris<sup>18</sup>. A 20 minute static headspace sampling using a 100  $\mu\text{m}$  polysiloxane-coated SPME fiber resulted in acceptable chromatograms from as little as 0.04  $\mu\text{L}$  gasoline compared to a 0.1  $\mu\text{L}$  volume required for regular headspace sampling at considerable savings in time, and at about half the cost. An example of the use of SPME headspace in forensic toxicology analysis was described by Brewer et al<sup>19</sup>. The authors investigated two traffic fatalities where in one case the conventional headspace analysis of a urine sample indicated that the driver had alcohol in his blood. However, a second unknown compound which eluted on the tail of a large air peak could not be easily ascertained by mass spectrometry. Using headspace SPME-GC/MS, a cleaner chromatogram resulted, allowing the identification of a toxic level of methylene chloride adjacent to the ethanol peak. The use of a polar fiber (85  $\mu\text{m}$  polyacrylate film) improved the sensitivity over a non-polar fiber (100  $\mu\text{m}$  polydimethylpolysiloxane) for the analysis of ethanol. In the second case, the victim had ingested lighter fluid, and headspace SPME-GC/MS of gastric juice was able to determine the presence of the lighter fluid and trace the source back to a container found in the victim’s bedroom. Since the measured compounds were straight chain alkanes, a non-polar fiber worked best in this case.

The analysis of various soils for BTEX and other volatile contaminants using SPME headspace analysis showed that each soil released these volatiles at different rates<sup>20,21</sup>. The addition of solvents and water served to release these compounds more effectively by displacing the hydrocarbons from the soil surface. SPME sampling with in-fiber derivatization was applied to the measurement of formaldehyde in the headspace of vials containing samples of commercial products known to contain formaldehyde, including hair gel and laminated particle board<sup>22</sup>. The sampling times range from 10-120 sec and resulted in very clean chromatograms and high signal-to-noise ratios. A method limit of detection of 2 ppb of formaldehyde was determined with an RSD of 6.7%.

Headspace SPME was used by chemists at a major pharmaceutical company for the determination of organic volatile impurities in drug substances as specified by the United States Pharmacopoeia (USP) Method 467<sup>23</sup>. They compared headspace SPME and immersion SPME with respect to precision, accuracy, and limits of detection, and found them to be essentially equal. Limits of detection ranged from 0.06  $\mu\text{g}/\text{mL}$  for 1,4-dioxane to 0.002  $\mu\text{g}/\text{mL}$  for benzene. Precision was generally in the 2-3% range for most of the solvents tested. The authors preferred the headspace sampling method since it prolonged the lifetime of the SPME fiber. Finally, Yang and Peppard<sup>24</sup> used SPME headspace sampling to monitor 25 common flavor components in spiked water, ground coffee, fruit juice, and butter-flavored vegetable oil.

## Headspace SDME

Single drop microextraction (SDME) has been evaluated as an alternative to SPME. In this straightforward technique, a microdrop of solvent is suspended from the tip of a conventional microsyringe and then immersed in a sample solution in which it is immiscible or suspended in the HS above the sample (see **Figure 6.5**). Headspace-single drop microextraction (HS-SDME) is similar to traditional HS sampling in that volatiles are sampled from the vapors above the sample, thus also avoiding interferences from the sample matrix. In HS-SDME, the fiber used in SPME is replaced by a liquid microdrop that can also be chosen for its selectivity. A variety of methods and specialized equipment is available for this purpose.

The extracting solvents that have been utilized for SDME are listed in **Table 6.1**. A wide range of solvents and polarities is possible. For HS sampling, the boiling point of the solvent should be high to avoid significant evaporation during sampling. To illustrate the application of HS-SDME, the analysis of residual solvents (RS) as performed in the pharmaceutical industry will be shown. Methods for the analysis of RS in pharmaceutical products are presented in the United States Pharmacopeia and include direct-liquid injection (DLI) as well as HS methods.

**Table 6.2**

### Solvents Used as Microdroplets in Headspace SDME

n-Octane	Toluene	Benzyl alcohol
n-Decane	o-Xylene	Ethylene glycol
Tetradecane	Cyclohexane	Diethylphthalate
n-Hexadecane	1-Octanol	

The International Conference on Harmonization (ICH) has classified four classes of RS that must be monitored in pharmaceutical formulations. Class 1 solvents have unacceptable toxicity and are to be avoided during pharmaceutical manufacture. They are not routinely analyzed, although confirmation of their absence could be part of the development process. Class 2 solvents are less toxic, Class 3 are "of lower risk to human health," and Class 4 are solvents for which no adequate toxicological data were found. These last three classes of solvents are the ones most commonly analyzed and have been analyzed using HS-SDME.

**Figure 6.5**  
**Configuration for Single Drop Headspace Microextraction**

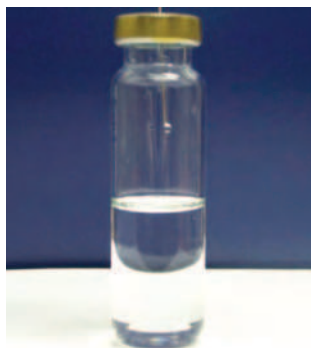

Wood and coworkers<sup>25</sup> investigated HS-SDME for the determination of RS in pharmaceutical preparations. The extraction drop ICH Class 2 solvent chosen was N-methylpyrrolidone (NMP) that has been used as a solvent for RS analysis because it is miscible with water, able to solubilize many pharmaceutical products, and elutes after most of the other residual solvents due to its relatively high boiling point (202 °C). The use of NMP precludes its determination in RS samples, as well as that of any other residual solvents that are higher boiling and elute with or after NMP. One or two  $\mu\text{L}$  of NMP was suspended approximately midway in the HS, as shown in **Figure 6.5**. After a defined period of time, usually four or five minutes, the drop was withdrawn back into the syringe, past the original volume mark, and injected into the GC. Using an internal standard, a number of ICH solvents (ethanol, acetone, 1-propanol, hexane, chloroform, tetrahydrofuran, cyclohexane, and toluene) were quantitatively analyzed by HS-SDME. RSD values for a manual method averaged around 2.7% and Limits of Detection (LOD) were estimated to be less than 1 ppm using GC/FID. With automation and GC/MS, limits of detection for HS-SDME were low parts per million and calibration curves were linear over the expected concentration range [e.g. ethanol's LOD was 0.08 ppm and its calibration curve gave R2 values exceeding 0.995 without an internal standard]. An example of a HS-SDME chromatogram is depicted in **Figure 6.6**<sup>25</sup>. It was noted that no carryover was observed.

Figure 6.6

### Determination of Residual Solvents Using Headspace SDME and GC/MS

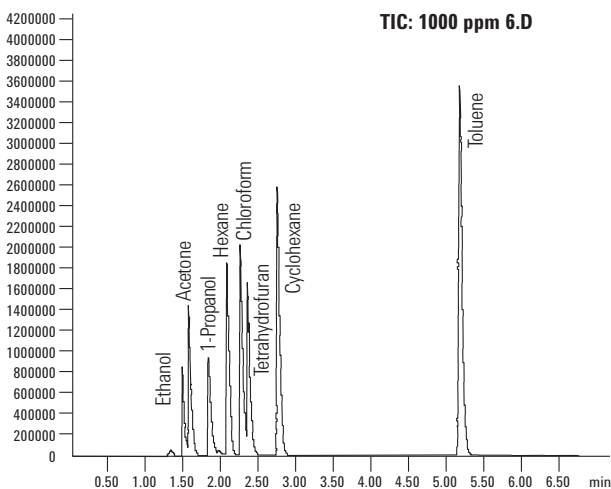

#### Experimental Conditions:

Instrument:	Agilent 6890 GC and Agilent 5973 MS
Column:	30 m HP-5ms
Data system:	Agilent ChemStation
Microsyringe:	Hamilton 1701, 10 $\mu\text{L}$ , gas-tight, needle point #2
GC temperatures (°C):	Injection: 250 Detector: 280
GC split ratio:	10:1
Sampling automation:	CTC Analytics CombiPAL
Sample vial:	20 mL
Sample size:	10 mL
	Wash with NMP, 3 times, 6 $\mu\text{L}$
Sample temp:	60 °C
Stirring rate:	750 rpm
Equilibration time:	30 min
Drop volume:	1.0 $\mu\text{L}$
Filling strokes:	3
Rate of drop expulsion:	0.2 $\mu\text{L}/\text{s}$
Extraction time:	5 min
Drop volume retracted:	1.2 $\mu\text{L}$

# Purge and Trap Sample Preparation

Dynamic headspace sampling continuously removes headspace vapors above a liquid or solid sample. The flow of gas over the sample (purging) will further volatilize analytes that can be trapped by an adsorbent or by cryogenic means. The trapping process will refocus (concentrate) the volatiles which are then re-volatilized into the gas chromatograph by thermal desorption (see *Thermal Desorption and Thermal Extraction*). The dynamic process of purge and trap is particularly useful for analytes that are too low in concentration to be measured by static headspace methods. Purge and trap (P&T), or gas phase stripping, generally refers to the process where purging gas is bubbled below the surface of a liquid sample using a fritted orifice to produce finely dispersed bubbles. Traps used in P&T are often the same as used in gas sampling. For volatile analytes, be careful to avoid breakthrough through the adsorbent trap during the P&T experiment. In addition, transfer lines and valves should be heated above the boiling points of removed analytes to prevent adsorption or condensation between the sampler and the GC instrument. There are many automated systems on the market that perform dynamic headspace extraction.

The proper selection of a trap is an important consideration in ensuring that the desired analytes are quantitatively recovered. An adsorbent trap (typically a glass tube) is filled with porous sorbent material (typically 50 mg to one gram) that could be a polymer (e.g. Tenax, polystyrene, polyurethane foams), carbon (graphitized carbon black, charcoal, carbosieves), silica gel, or alumina. Polymeric materials sometimes need to be cleaned prior to use in order to remove residual monomer. Tenax is especially useful since it is hydrophobic, water is unretained, and it has a high sample capacity. Carbon materials are excellent, high capacity traps, but sometimes irreversibly adsorb certain classes of analytes. Silica gel and alumina have high capacity but take up water. These traps containing adsorbent may also be used off-line to collect volatile organic samples from air and then transported back to the laboratory for subsequent analysis. As mentioned above, analytes are transferred to the GC by thermal desorption (see *Thermal Desorption and Thermal Extraction*), perhaps coupled with cold trapping via cryogenics to refocus the analytes.

An especially important parameter of a particular trap is the breakthrough capacity, which determines how much organic material is trapped from the gaseous sample before it elutes from the opposite end of the trap and is no longer retained. Volatile organics may pass through a trap very quickly while semi- or non-volatile organics may adsorb strongly and never elute. For volatile organics, the trap may be cryogenically cooled or a different adsorbent material may be used that has a higher breakthrough volume for the analyte.

In general, the dynamic HS methods are best when looking for minor components that are more volatile than the major component, such as fragrances in beverages. The P&T-GC techniques are especially useful for determining organic volatiles from biological fluids such as urine, plasma, saliva, and tissue homogenates. In addition, the United States Environmental Protection Agency specifies the dynamic technique for low concentrations of volatile organics in water under the SW-846 Method 5030A. Other examples where purge and trap methods are recommended in environmental analyses are for: low concentrations of halogenated volatile compounds in water, soil, and waste samples (Method 502.1), volatile aromatics in drinking water (Method 503.1), and non-halogenated volatile organics in the same environmental matrices (Method 8030A). Static and dynamic headspace may be used for the qualitative and/or quantitative determination of volatile impurities, residual monomers, and other additives in polymers. A useful application for dynamic HS in forensics has been the investigation of arson accelerants since light and medium petroleum distillates are cleanly swept away from debris, but recoveries with the higher molecular weight petroleum distillates are usually low.

In a variation of the dynamic headspace experiment called membrane extraction with a sorbent interface (MESI), Pawliszyn and coworkers<sup>26,27</sup> have inserted a silicone hollow fiber membrane in the headspace above the solid or liquid sample. The entire experimental setup is depicted in **Figure 6.7**. The membrane extraction module furnishes an interface that effectively isolates analytes of interest from their sample matrix. In the experimental setup, an inert gas passes through the inside of the membrane. Analytes that are permeable to the membrane pass from the headspace through the membrane and are swept to an adsorbent trap. The sorbent interface includes the trap, a heating coil, and a computer-controlled heater-switching device with a power supply. The module physically connects the membrane extraction module to the GC separation column.

Once a sufficient analyte concentration is accumulated on the adsorbent trap, the analytes are rapidly thermally desorbed into the GC instrument. The sorbent interface can be operated in the cryogenic mode for better absorption capacity and analyte focusing. The sensitivity of MESI is directly related to the trapping time that is limited by the breakthrough time of the analytes in the adsorbent trap. The MESI technique has been applied to a number of environmental samples such as hydrocarbons in rainwater runoff from a parking lot and BETX in various matrices.

Figure 6.7

## Schematic of a GC Setup for Membrane Extraction with a Sorbent Interface

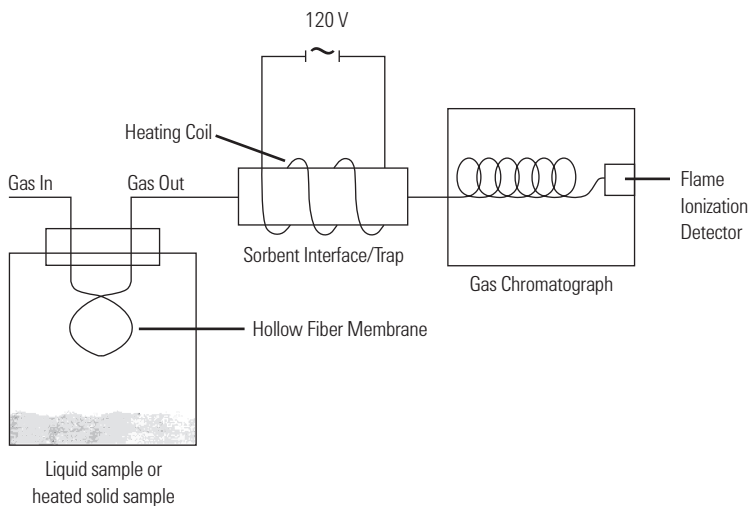

## Thermal Desorption and Thermal Extraction

Thermal desorption is a widely used technique for liberating volatile analytes from a solid sample or adsorbent. The technique can be used standalone for solid samples containing volatile compounds (e.g. petroleum hydrocarbons in soil, additives in finely ground polymers), or in conjunction with a dynamic headspace method (see section 6.4) where an inert gas transfers volatiles from liquids or solid samples to an adsorbent trap. Thermal extraction is very similar, except that there is not another trapping step in the volatiles removal (extraction) process. No sample preparation is involved nor is any solvent employed. In thermal extraction, the solid sample (1-500 mg) is placed in desorption tube between two glass wool plugs. After purging the tube to remove all traces of oxygen, a preheated heater block or a heating coil is positioned around the desorption tube and the temperature rapidly ramped up permitting the thermal extraction of volatiles and semi-volatiles from the solid sample. These compounds are swept into the GC instrument and trapped at the head of the column. Temperature programming is used to separate the compounds of interest. In thermal desorption for volatile compounds, the temperature of desorption rarely exceeds 200 °C and often lower, while in thermal extraction, temperatures up to 300 °C may be used. Beyond 300 °C, thermal cracking or pyrolysis may occur.



In thermal desorption, the time required for the complete desorption of analytes is a function of the sample matrix, sample size, strength of interaction between the analyte and the solid surface, desorption temperature, and diffusion time of the analytes out of the sample. In general, thermal desorption is a slow process and generates broad peaks. For this reason, a solute focusing technique is almost always used to ensure better chromatography. Direct (single stage) thermal desorption is the nomenclature used when the extracted volatiles are swept directly into the GC column while two stage thermal desorption is the process of using a cold trap to accumulate and focus volatile analytes on an adsorbent. In all cases, to avoid sample losses for both thermal desorption or thermal extraction, heated transfer lines, preferably of inert material, are generally used.

Thermal desorption tubes are generally used in the field to collect trace levels of volatile- or semi-volatile organic compounds or they could be packed with solid sample which are to be extracted in the laboratory. For collection of VOCs in air, the tubes may be packed with various types of adsorbents (e.g. Tenax, charcoal, inorganic materials, etc.) that are somewhat selective for the organic compounds to be analyzed. Usually some type of controlled flow system is used to push air through the tubes as a function of time.

Thermal desorption instruments are available which automate the handling of the sample-filled desorption tubes including loading/unloading the thermal tubes and heating the tubes to a sufficient temperature to remove all analytes of interest. The process has the advantage of little manual sample preparation, no solvents are used, and therefore there is no analytical interference from solvent nor solvent disposal costs to consider. Although single stage thermal desorption is possible, some re-focusing of the effluent from the tube is required. Capillary cryofocusing, cold trapping, or an electrically-cooled sorbent trap is used for this purpose. For cost reasons (liquid cryogen consumption), the latter approach is preferred. The trap can be re-heated rapidly in a backflush mode and 99+% of the analytes are desorbed in a few seconds.

Thermal desorption has been used for the analysis of a wide variety of low moisture content solid samples including vegetation, food products, pharmaceuticals, building materials, forensic samples, and packaging products. Other important application areas include environmental monitoring, flavor and fragrances, industrial hygiene, and chemical warfare agents. For general overviews of thermal desorption and its applications, refer to references 28-30.

# The Role of Pyrolysis in Sample Preparation

Pyrolysis is the next stage in thermal extraction techniques, but has one important difference compared to the other thermal techniques. The temperatures used in pyrolysis are high enough (600-800 °C) to actually break molecular bonds in the molecules of the solid sample, thereby forming smaller, simpler volatile compounds. Depending on the amount of energy supplied, the bonds in each molecule break in a predictable manner. By the identification and measurement of the fragments, the molecular composition of the original sample can often be reconstructed. Pyrolysis may not be thought of as a sample preparation technique, but more of a sample destructive technique since the actual molecular form of the sample is changed upon heating. Pyrolysis is often used for the analysis of polymer samples since they are too high of a molecular weight to analyze using gas chromatographic techniques and they often degrade in a systematic fashion.

Synthetic polymers (e.g. polyvinylchloride, polystyrene, polyesters), natural polymers (e.g. plant fibers such as cellulose and cotton, and animal fibers such as wool and silk), dried paints, and cosmetic samples are examples of samples that can be characterized by pyrolysis GC. Using pyrolysis, considerable information may be obtained on the basic structure of polymers as well as polymer defects, variations, and degradation mechanisms.

Normally pyrolysis is performed in an inert atmosphere so that there is a controlled pyrolysis and predictable degradation. However, pyrolysis can also be carried out in a reactive atmosphere such as air or oxygen. The degradation mechanisms may be quite different when compared to those in helium. These studies on materials such as polymers can be useful for combustion studies, toxicology, and in evaluating the atmospheric stability of a material. The pyrolysis is first performed in a reactive environment and the pyrolysates collected on an adsorbent trap while the reaction gas is vented. Then, to perform the GC analysis, a gas-switching valve is employed to divert the GC carrier gas through the trap and thermal desorption to desorb the collected organics to the GC instrument.

Cryogenic focusing may also be used to concentrate and focus degraded volatile fragments and compensate for system dead volume. Cryofocusing may be used in conjunction with an adsorbent trap or used with on-column concentration followed by temperature programming. For more information on pyrolysis GC, consult reference 31.

# Conclusions

Methodologies for the sampling, sample introduction, and sample preparation of volatile analytes in conjunction with GC and GC/MS analysis covered in this chapter have been around for many years and are considered to be mature. However, each year there are many practical problems solved, applications examples generated, hardware and software improvements made, and new ancillary techniques introduced to keep these methods on the forefront of analytical technologies. For example, the addition of a hollow fiber membrane to the dynamic headspace experiment provides an additional level of selectivity in the MESI technique. The introduction of automated LVI methodologies has given the analyst the ability to introduce greater amounts of liquid sample into the capillary GC instrument. Thus, there is no doubt that in the future we shall continue to see improvements in the methodology around the sample handling of volatile organic analytes.

## References

---

1. Grob, R.I.; Barry, E.F. (Eds.) *Modern Practice of Gas Chromatography*, 4th Ed., John Wiley and Sons, Hoboken, NJ, **2004**, ISBN 0-471-22983-0.
2. McNair, H.M.; Miller, J.M. *Basic Gas Chromatography*, 2nd Ed., John Wiley and Sons, Hoboken, NJ, **2009**, ISBN 978-0-470-43954-8.
3. Poole, C. *Gas Chromatography*, Elsevier, Oxford, U.K., **2012**, ISBN 978-0-12-385540-4.
4. Poy, E.S.; Visani, F.; Terrosi, F. *J. Chromatogr.* **1981**, 217, 81.
5. Vogt, W.; Jacob, K.; Obwexer, H.W. *J. Chromatogr.* **1979**, 174, 437.
6. Vogt, W.; Jacob, K.; Ohnesorge, A.B.; Obwexer, H.W. *J. Chromatogr.* **1979**, 186, 197.
7. Staniewski, J.; Rijks, J. *HRC* **1993**, 16, 182.
8. Wilson, B.; Wylie, P.L.; Klee, M.S. *Large Volume Injection for Gas Chromatography Using a PTV Inlet*, Application Note #228-374, Hewlett-Packard, Wilmington, DE, **1997**.
9. Li, X. *Analysis of Ethanol in Blood with the Agilent 7820A GC and 7697A Headspace Sampler*, Application Note #5990-9021EN, Agilent Technologies, Santa Clara, CA, **2011**.
10. Kolb, B.; Ettre, L.S. *Static Headspace-Gas Chromatography: Theory and Practice*, 2nd Ed., Wiley-VCH Inc., New York, **2006**, ISBN 0-471-74944-3.
11. Firor, R.L.; Gudat, A.E. *The Determination of Extractables and Leachables in Pharmaceutical Packaging Materials Using Headspace GC/MS*, Application Note #5989-5494EN, Agilent Technologies, Wilmington, DE, **2006**.
12. Firor, R.L. *Residual Monomers in Polymers by Multiple Headspace Extraction Using the Agilent 7697A Headspace Sampler*, Application Note #5990-0342EN, Agilent Technologies, Wilmington, DE, **2012**.
13. Kolb, B.; Ettre, L.S. *Chromatographia* **1991**, 32, 505-513.
14. Zhu, J.Y.; Chai, X.-S. *Current Analytical Chemistry* **2005**, 1, 79-83.
15. Gudat, A.E.; Brillante, S.M. *Multiple Headspace Extraction-Capillary Gas Chromatography for the Quantitative Determination of Volatiles in Solid Matrices*, Application Note #5965-0978E, Agilent Technologies, Wilmington, DE, **2000**.

(Continued)

## References (Continued)

---

16. Arthur, C.L.; Potter, D.W.; Buchholz, K.D.; Motlagh, S.; Pawliszyn, J. *LCGC* **1992**, 10, 656-661.
17. Zhang, Z.; Yang, M.J.; Pawliszyn, J. *Anal. Chem.* **1994**, 66, 844-852A.
18. Furton, K.G.; Almirall, J.R.; Bruna, J.C. J. *Forensic Sci.* **1996**, 41, 12-22.
19. Brewer, W. E.; Galipo, R.C.; Morgan, S.L.; Habben, K.H. J. *Anal. Toxicology* **1997**, 21, 286-290.
20. Pawliszyn, J. *SPME Theory and Practice*, Wiley-VCH Inc., New York, **1997**, 161-170, ISBN 0-471-19034-9.
21. Saraullo, A. Ph.D. Thesis, Univ. of Waterloo, Waterloo, Ontario, Canada.
22. Martos, P.A.; Pawliszyn, J. *Anal. Chem.* **1998**, 70, 311-2320.
23. Shaw, R.; Smith, A.-M.; Clark Nelson, L.; Scypinski, S. Hoffman-La Roche Inc., Nutley, NJ, Poster presentation, Amer. Assoc. of Pharmaceutical Sciences Conference, June, 1994.
24. Yang, X.; Peppard, T. J. Agric. *Food Chemistry* **1994**, 42, 1925-1930.
25. Wood, D.C.; Miller, J.M.; Christ, I. *LCGC No. America* **2004**, 22 (6), 516-522.
26. Pratt, K.F.; Pawliszyn, J. *Anal. Chem.* **1992**, 64, 2101-2106.
27. Yang, M.J.; Pawliszyn, J. *LC/GC* **1996**, 14, 364-376.
28. Wampler, T.P. *LC/GC* **1998**, 16 (9), 812-821.
29. *Round-the-Clock, Online and Cryogen-free Monitoring of Hydrocarbons in Ambient Air Using Thermal Desorption-Gas Chromatography*, Technical Overview #5988-9254EN, Agilent Technologies, **2003**.
30. *Optimizing Analytical Performance and Extending the Application Range of Thermal Desorption for Monitoring Air Indoors and Inside Vehicle Cabins*, Technical Overview #5988-9255EN, Agilent Technologies, **2003**.
31. *Introduction to Pyrolysis-Capillary Gas Chromatography*, *CDS Analytical Solutions*, Publication Number 178, <http://www.cdsanalytical.com>.

# Sample Pre-treatment for Liquid Samples

Previously, in Chapter 2, Table 2.4 provided an introduction to sample preparation methods for liquid samples. Most laboratories need only a few of these procedures. For example, distillation is limited to volatile compounds, although vacuum distillation for high boilers in environmental samples can extend the application of this technique. Lyophilization is usually restricted to the purification and handling of biological samples through the removal of water. This chapter will cover liquid-liquid extractions in more common use in most chromatography laboratories.

## Liquid-Liquid Extraction (LLE)

Liquid-liquid extraction (LLE) is useful for separating analytes from interferences by partitioning the sample between two immiscible liquids or phases (**Figure 7.1**). One phase in LLE will usually be aqueous and the second phase an organic solvent. The more hydrophilic compounds prefer the polar aqueous phase, while more hydrophobic compounds will be found mainly in the organic solvent. Analytes extracted into the organic phase are easily recovered by evaporation of the solvent, while analytes extracted into the aqueous phase often can be injected directly onto a reversed-phase HPLC column. In some cases, the aqueous-containing phase must undergo solvent exchange to a solvent more compatible with the chromatographic approach. The most popular approach to LLE uses a separatory funnel (**Figure 7.2**), which has an opening on the top to add the two phases and a stopcock at the bottom to selectively remove the bottom layer after the partitioning process takes place. A separatory funnel is preferred if the organic solvent has a higher density than water (e.g. dichloromethane), and thus is the bottom layer.

Figure 7.1

## Typical Liquid-Liquid Extraction

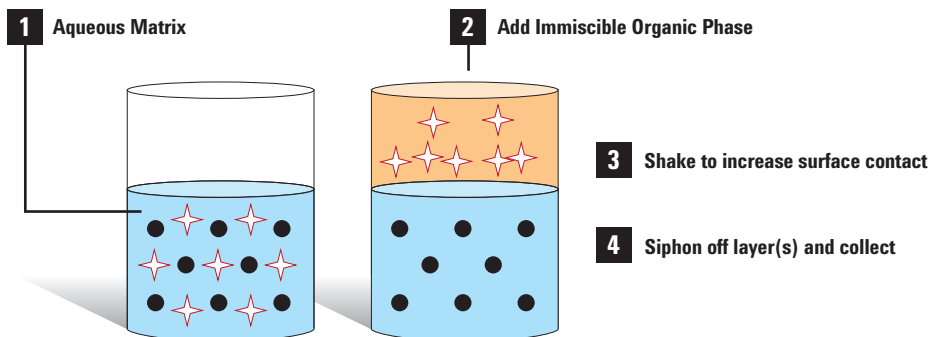

The following information assumes that an analyte is preferentially concentrated into the organic phase, but similar approaches are used when the analyte is extracted into an aqueous phase.

Figure 7.2

## LLE Performed in Separatory Funnel

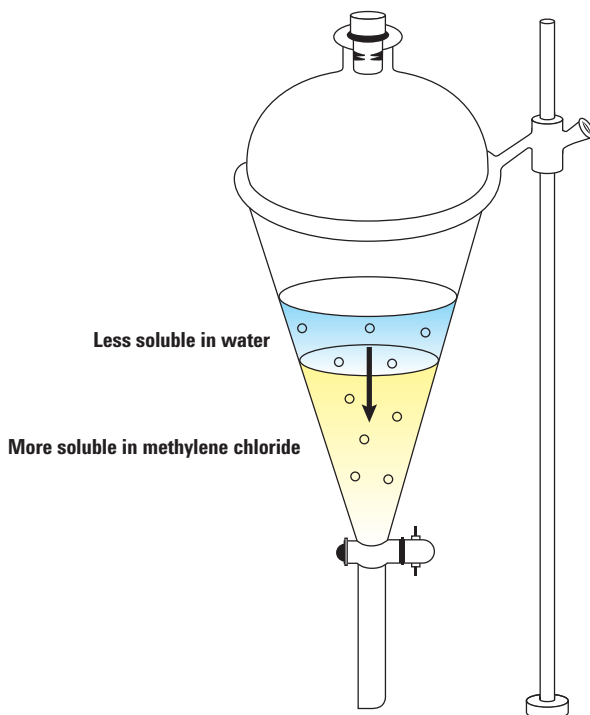

**Figure 7.3** summarizes the workflow steps involved in a LLE separation. Since extraction is an equilibrium process with limited efficiency, significant amounts of the analyte can remain in both phases. Chemical equilibria involving changes in pH, ion-pairing, complexation, etc. can be used to enhance analyte recovery and/or the elimination of interferences.

Figure 7.3

### Summary of Steps Involved in Liquid-Liquid Extraction (LLE)

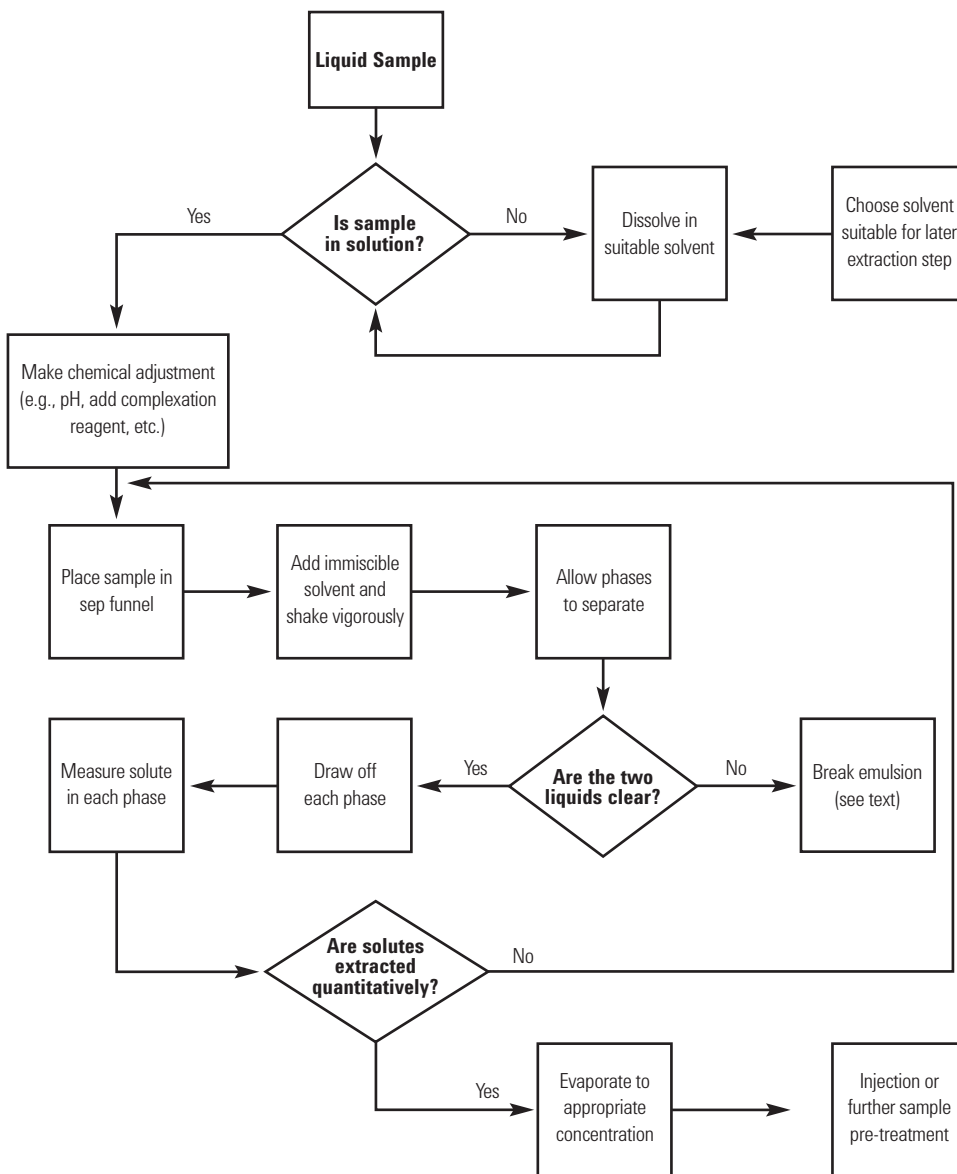

The LLE organic solvent is chosen for the following characteristics:

- A low solubility in water (<10%).
- Volatility for easy removal and concentration after extraction.
- Compatibility with the HPLC or GC detection technique to be used for analysis (avoid solvents that are strongly UV-absorbing or that may cause GC detection problems, such as chlorinated solvents in conjunction with electron capture detector).
- Polarity and hydrogen-bonding properties that enhance recovery of the analytes in the organic phase.
- High purity to minimize sample contamination.

## Theory

The Nernst Distribution Law states that any neutral, non-dissociating species will distribute between two immiscible solvents so that the ratio of the concentrations (or for the purist, activities) remains constant.

$$K_D = C_o / C_{aq} \quad \text{Equation 7.1}$$

where  $K_D$  is the distribution constant,  $C_o$  is the concentration (activity) of an analyte in the organic phase, and  $C_{aq}$  is the concentration (activity) of the analyte in the aqueous phase.

A more useful expression is the fraction of analyte extracted (E) given by Equation 7.2:

$$E = C_o V_o / (C_o V_o + C_{aq} V_{aq}) = K_D V / (1 + K_D V) \quad \text{Equation 7.2}$$

where  $V_o$  is the volume of organic phase,  $V_{aq}$  the volume of aqueous phase, and  $V$  is the phase ratio  $V_o / V_{aq}$ .

Many LLE procedures are carried out in separatory funnels, and for environmental samples (e.g. water) typically require tens or hundreds of milliliters of each phase. For clinical samples, sometimes only a few mL (e.g. 1-3 mL) are required.



For 1-step extractions,  $K_D$  must be large (e.g.,  $>10$ ) for the quantitative recovery of an analyte in one of the two phases, since the phase-ratio  $V$  must be maintained within a practical range of values; e.g.,  $0.1 < V < 10$  (see **Equation 7.2**). In most separatory funnel LLE procedures, quantitative recoveries ( $>$  than 99%) require two or more extractions. For successive multiple extractions, with pooling of the analyte phases from each extraction,

$$E = 1 - [1/(1 + K_D V)]^n \quad \text{Equation 7.3}$$

where  $n$  = the number of extractions. For example, if  $K_D = 5$  for an analyte and the volumes of the two phases are equal ( $V=1$ ), three extractions ( $n=3$ ) would be required for  $>99\%$  recovery of the analyte. Several approaches can be used to increase the value of  $K_D$ :

- The organic solvent can be changed to increase  $K_D$ .
- If the analyte is ionic or ionizable, its  $K_D$  can be increased by suppressing its ionization to make it more soluble in the organic phase.
- The analyte also can be extracted into the organic phase by ion pairing, provided that the analyte is ionized and an ion-pair reagent is added to the aqueous phase.
- "Salting out" by addition of an inert, neutral salt (e.g. sodium sulfate) can be used to decrease an analyte's concentration in the aqueous phase. See Chapter 8 for an explanation of the use of salting out extraction.

## Practice

**Table 7.1** provides examples of typical extraction solvents, as well as some unsuitable (water-miscible) extraction solvents. Apart from miscibility considerations, the main selection criteria is the polarity index  $P^1$  of the solvent in relation to that of the analyte. Maximum  $K_D$  occurs when the polarity of the extraction solvent matches that of the analyte (like dissolves like). For example, the extraction of a non-polar analyte from an aqueous sample matrix would be best accomplished with a non-polar (small  $P^1$ )<sup>1-2</sup> organic solvent. An optimum-polarity organic solvent can be conveniently selected by blending two solvents of different polarity (e.g., hexane and chloroform), and measuring  $K_D$  vs. the composition of the organic phase<sup>3</sup>. A solvent mixture that gives the largest value of  $K_D$  is then used for the LLE procedure. Further changes in  $K_D$  can be achieved, while improving the separation of analytes from interferences, by varying organic-solvent selectivity. Solvents from different regions of the solvent-selectivity triangle<sup>4</sup> are expected to provide differences in selectivity; see also the discussion of<sup>4</sup>. Note that further discussions on the polarity index  $P^1$  and the solvent-selectivity triangle are beyond the scope of this book and the reader is referred to the original reference cited above.

Table 7.1

Extraction Solvents for LLE		
Aqueous Solvents	Water-Immiscible Organic Solvents	Water-Miscible Organic Solvents (Unsuitable for Conventional LLE)
Pure water	Aliphatic hydrocarbons (hexane, isooctane, petroleum ether, etc.)	Alcohols (Low molecular weight)
Acidic solution	Diethyl ether or other ethers	Ketones (Low molecular weight)
Basic solution	Methylene chloride	Aldehydes (Low molecular weight)
High salt (salting out effect)	Chloroform	Carboxylic acids (Low molecular weight)
Complexing agents (ion pairing, chelating, chiral, etc.)	Ethyl acetate and other esters	Acetonitrile
Combination of two or more above	<ul style="list-style-type: none"> <li>• Aliphatic ketones (C6 and above)</li> <li>• Aliphatic alcohols (C6 and above)</li> <li>• Toluene, xylenes (uv absorbance!)</li> <li>• Combination of two or more above</li> </ul>	Dimethyl sulfoxide Dioxane

\*Any solvent from column 1 can be matched with any solvent of column 2; water-miscible organic solvents (column 3) should not be used with aqueous solvents to perform conventional LLE. However, the addition of high concentration of salts (salting out) or sugars (see Chapter 8) may decrease miscibility of certain solvent pairs (e.g. water and acetonitrile) so that they may form two layers.

In solvent extraction, ionizable organic analytes often can be transferred into either phase, depending on the selected conditions. For example, consider the extraction of an organic acid analyte from an aqueous solution. If the aqueous phase is buffered at least 1.5 pH units above its  $pK_a$  value, the analyte will be ionized and prefer the aqueous phase; less polar interferences will be extracted into the organic phase. If the pH of the aqueous solution is lowered ( $\ll pK_a$ ), so that the analyte is no longer ionized, the analyte will be extracted into the organic phase, leaving more polar interferences in the aqueous phase. Successive extractions at high pH followed by low pH are able to separate an acid from both more- and less-polar interferences. Note that the principles of acid-base extraction as a function of pH are the same for LLE and reversed-phase HPLC.

If the analyte  $K_D$  is unfavorable, additional extractions may be required for improved recovery (**Equation 7.3**). For the case of an organic-soluble analyte, a fresh portion of immiscible organic solvent is added to the aqueous phase in order to extract additional solute; all extracts are then combined. For a given volume of final extraction solvent, multiple extractions with smaller volumes are generally more efficient in removing a solute quantitatively than use of a single extraction volume.

Back extraction can be used to further reduce interferences. For example, consider the previous example of an organic-acid analyte. If the analyte is first extracted at low pH into the organic phase, polar interferences (e.g., hydrophilic neutrals, protonated bases) are left behind in the aqueous phase. If a fresh portion of high pH aqueous buffer is used for the back-extraction of the organic phase, the ionized organic acid is transferred back into the aqueous phase, leaving non-polar interferences in the organic phase. This latter procedure is similar to successive extractions at high pH followed by low pH described above. Thus, a two-step back-extraction with a change in pH allows the removal of both basic and neutral interferences, whereas a one-step extraction can eliminate one or the other of these interferences, but not both.

If  $K_D$  is very small (not much greater than 1) or the required quantity of sample is large, it becomes impractical to carry out multiple extractions for quantitative recovery of the analyte. Too many extractions are required, and the volume of total extract is too large (**Equation 7.3**). Also, if extraction is slow, a long time may be required for equilibrium to be established. In these cases, continuous liquid-liquid extraction can be used, where fresh solvent is continually recycled through the aqueous sample.

Continuous extractors using heavier-than-water and lighter-than-water solvents have been described<sup>5</sup>. These extraction devices can run for extended periods (12-24 hours); quantitative extractions (>99% recovery) can be achieved, even for small values of  $K_D$ .

For more efficient LLE, a countercurrent distribution apparatus can provide a thousand or more equilibration steps (but with more time and effort). This allows the recovery of analytes having extremely small  $K_D$  values; countercurrent distribution also provides a better separation of analytes from interferences. Small-scale laboratory units are commercially available. For further information on these devices, see reference 6.

In some cases, LLE can enhance analyte concentration in the extract fraction relative to its concentration in the initial sample. According to **Equation 7.2**, by choosing a smaller volume of organic solvent, the analyte concentration can be increased by the volumetric ratio of organic-to-aqueous phases (assuming near complete extraction into the organic phase or large  $K_D$ ). For example, assume 100 mL of aqueous sample, 10 mL of organic solvent, and a large  $K_D$  (e.g.,  $K_D > 1000$ ). The concentration of the analyte in the organic phase will then increase by a factor of 10. For large ratios of aqueous-to-organic solvent, a slight solubility of the organic solvent in the aqueous phase can reduce the volume of the recovered organic solvent significantly; this problem can be avoided by presaturating the aqueous solvent with organic solvent. Note that when the solvent ratio  $V_o/V_{aq}$  is small, the physical manipulation of two phases (including the recovery of organic phase) becomes more difficult.

## Problems

Some practical problems associated with LLE include:

- Emulsion formation
- Analytes strongly adsorbed to particulates
- Analytes bound to high molecular weight compounds (e.g. protein-drug interactions)
- Mutual solubility of the two phases

## Emulsion Formation

Emulsions are a problem that can occur with certain samples (e.g. fatty matrices) under certain solvent conditions. If emulsions do not "break" with a sharp boundary between the aqueous and organic phases, analyte recovery can be adversely affected.

Emulsions can be broken by:

- Addition of salt to the aqueous phase
- Heating or cooling the extraction vessel
- Filtration through a glass wool plug
- Filtration through phase-separation filter paper
- Addition of a small amount of different organic solvent
- Centrifugation

## Analyte Adsorption

If particulates are present in a sample, adsorption onto these particulates can result in a low recovery of the analyte. In such cases, washing the particulates after filtration with a stronger solvent will recover the adsorbed analyte; this extract should be combined with the analyte phase from LLE. A "stronger" solvent for recovering adsorbed analytes may involve a change in pH, an increase in ionic strength, or the use of a more polar organic solvent.

## Solute Binding

Compounds that normally are recovered quantitatively in LLE may bind to proteins when plasma samples are processed, resulting in low recovery. Protein binding is especially troublesome when measuring drugs and drug metabolites in physiological fluids. Techniques for disrupting protein binding in plasma samples include:

- Addition of detergent
- Addition of organic solvent, chaotropic agents, or strong acid
- Dilution with water
- Displacement with a more strongly binding compound

## Mutual Phase Solubility

"Immiscible" solvents have a small but finite, mutual solubility, and the dissolved solvent can change the relative volumes of the two phases. Therefore, it is a good practice to saturate each phase with the other, so that the volume of phase containing the analyte can be known, accurately allowing an optimum determination of analyte recovery. The simplest procedure for saturation is to equilibrate the two phases in a separatory funnel without the sample, thereby saturating each phase. Aliquots of either phase can then be used for LLE. For values of the solubility of a solvent in water (or of water in the solvent), see reference 7.

## Supported Liquid Extraction (SLE)

Earlier, under *Problems*, some of the problems associated with traditional LLE were addressed. An alternative approach that gets around some of these disadvantages has been available for some time, yet is relatively unknown – supported liquid extraction (SLE, sometimes referred to as solid-supported liquid extraction, supported liquid-liquid extraction, or simply, solid-liquid extraction). Its principles are relatively simple – a chemically inert, high surface area support, highly purified, graded diatomaceous earth serves as a stationary vehicle for the aqueous phase of the LLE experiment. Water very easily adsorbs onto the surface of diatomaceous earth particles. The dry solid sorbent (**Figure 7.4A**) is placed into a cartridge, column, or well of a 96-well plate, the same devices used for solid phase extraction (SPE). As depicted in **Figure 7.4B**, the aqueous-based sample (e.g. diluted plasma, drinking water, etc.) is added to the dry sorbent and allowed to wet (disperse by capillary action and absorb) the diatomaceous earth, a process that only takes 5-15 minutes under gravity. Oftentimes, the aqueous sample is pretreated (i.e. pH adjustment, ion pairing agent added, buffered, etc.) such that the analyte(s) of interest is/are in a suitable form to be extracted into an organic solvent, just as performed for conventional LLE. Pre-buffered SLE cartridges are also commercially available.

Next, a small volume of immiscible organic extraction solvent is added to the top of the cartridge and allowed to percolate by gravity (or sometimes with gentle vacuum or pressure) through the supported aqueous phase. Because the aqueous sample has been widely dispersed throughout the solid support, the organic solvent has intimate contact with the thin film of aqueous phase and rapid extraction (equilibration) occurs (**Figure 7.4C**). This intimate contact also occurs in LLE due to vigorous shaking of the separatory funnel. This shaking causes the immiscible organic solvent to disperse into tiny droplets that provide a closer contact to the surrounding aqueous solvent. The downside of this dispersion process in LLE is that emulsions can form and/or a long time is needed for the two phases to separate. In addition, as pointed out in Emulsion Formation, it may take some additional time to break the emulsion.

Figure 7.4

## Supported Liquid Extraction Process

Figure 7.4A

### Step 1 Before extraction

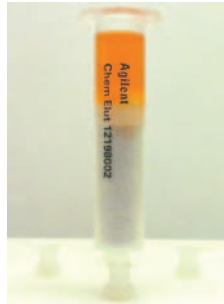

Aqueous sample being applied

Figure 7.4B

### Step 2 Apply sample

- Analyte of interest
- ▲ Undesired matrix compounds or interferences

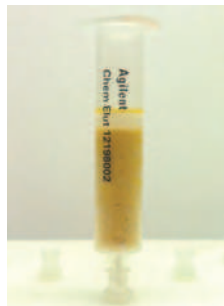
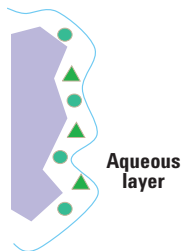

Solid support adsorbs aqueous-based sample onto high surface area particles

Allow 10-15 min for aqueous phase to spread out over diatomaceous earth

The final step in the process is collection of the organic effluent containing the analyte(s) of interest from the outlet of the SLE device (**Figure 7.4C**). The aqueous phase remains behind. A phase-separation filter is incorporated into the outlet frit of the device to ensure that organic effluents remain uncontaminated by aqueous matrix.

Figure 7.4C

### Step 3 Extract with organic solvent

- Analyte of interest
- ▲ Undesired matrix compounds or interferences

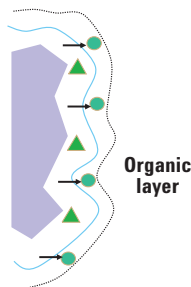

Organic extraction solvent

Collected organic effluent



With SLE, there is no vigorous shaking and therefore emulsions cannot be formed. In addition, the intimate contact between the aqueous and organic phases allows very efficient partitioning, thus analyte recoveries can sometimes be higher than in conventional LLE. Furthermore, the SLE process is more technique independent than conventional LLE, thus, experiments are often more reproducible. Obviously, the glassware involved in SLE is greatly reduced compared to classical LLE and no cumbersome washing of the soiled separatory funnel is required. The entire SLE process can be more easily automated than using separatory funnels in traditional LLE. The 96-well plate SLE format (Combitute) is especially amenable to automation using x-y-z robotics systems. Prepacked SLE products such as Agilent's Chem Elut are available in all automation formats. In addition, bulk sorbent such as Agilent's Hydromatrix can be purchased for those who wish to make their own customized SLE devices.

The SLE approach can basically duplicate any developed LLE method with a few minor adjustments. In general, 1 g of diatomaceous earth sorbent is needed for each 1 mL of aqueous sample. Cartridge size is determined by the total volume of sample that needs to be extracted. The volume extracted is dependent on the concentration of the analyte(s) of interest, the total volume of sample available, and the sensitivity of the analytical system that will make the downstream measurement. For an environmental sample (e.g. for screening pesticides in water), cartridge volumes of up to 100 mL aqueous capacity are available. For biological samples (e.g. plasma or urine), in conjunction with LC-MS/MS (triple quadrupole analysis), the excellent sensitivity would dictate a smaller sample volume. For example, for 96-well plates with a 2 mL well volume, 200-400  $\mu$ L (max 500  $\mu$ L) of plasma can be extracted with pg/mL sensitivity. For the organic extraction, the volume of organic solvent should be at least equivalent to the volume of aqueous sample. As a rule of thumb, at least two column volumes of organic extraction solvent are recommended for maximum recovery.

Almost any non-polar solvent can be used as the immiscible organic phase. The organic solvent should be spectroscopic grade or above, since often the collected fraction is evaporated to dryness. Any solvent containing non-volatile impurities will be unsuitable for performing clean extractions. Pure organic solvents or organic solvent mixtures can be employed. **Table 7.2** provides a list of solvent mixtures compatible with SLE. The column to the right of each solvent pair indicates the maximum percentage of polar solvent tolerated. Exceeding the maximum water-miscible solvent percentage may have a detrimental effect on cleanup since some of the aqueous phase containing impurities may be stripped from the diatomaceous earth.

Table 7.2

## Solvent Mixtures Compatible with SLE

Mixture	Max % Water-Miscible Solvent	Mixture	Max % Water-Miscible Solvent
CH <sub>2</sub> Cl <sub>2</sub> /MeOH	20% MeOH	Toluene/THF	70% THF
CH <sub>2</sub> Cl <sub>2</sub> /Acetone	20% Acetone	Toluene/DMF	30% DMF
CH <sub>2</sub> Cl <sub>2</sub> /DMF	10% DMF	EtOAc/DMF	10% DMF
CH <sub>2</sub> Cl <sub>2</sub> /DMA	10% DMA	EtOAc/THF	70% THF
CH <sub>2</sub> Cl <sub>2</sub> /NMP	20% NMP	EtOAc/IPA	60% IPA
CH <sub>2</sub> Cl <sub>2</sub> /THF	70% THF	EtOAc/MeOH	10% MeOH
CH <sub>2</sub> Cl <sub>2</sub> /CH <sub>3</sub> CN	10% CH <sub>3</sub> CN	Et <sub>2</sub> O/THF	50% THF

Adapted from Breitenbucher, J.G. et al. *J. Comb. Chem.* **2001**, 3, 528-533.

To illustrate an application of SLE compared to LLE, consider the multiresidue confirmation of pesticides in honey<sup>8</sup>. This application is very important in the area of food safety. Bees gathering pollen from blossoms treated with various pesticides carry the contaminated pollen back to their hives. This contaminated pollen could result in the decline of bee populations or in the development of contaminated honey. Since bees can gather pollen from many different sources, a multiresidue approach is needed to test honey for possible contamination. The study by Picard investigated 17 pesticides and metabolites from a variety of chemical classes. The extraction of pesticides was performed by SLE and compared to the results obtained by traditional LLE.

Initially, classical LLE was used to extract pesticides from honey. A 1 g sample of honey was dissolved in 2 mL of water. Next, 6.5 mL of acetonitrile was added and the mixture mechanically shaken for 30 min. The high concentration of sugar in the honey sample was analogous to the salting out effect, or in this case, a sugaring out effect (see Chapter 8 for explanation) that caused the two solvents to layer. The organic and aqueous layers were separated by centrifugation. The organic layer was evaporated down to 100  $\mu$ L and added to 100  $\mu$ L of water. This extract was filtered and injected into an LC-MS/MS system. For the SLE approach, a 1 g sample of honey was spiked with a surrogate standard before mechanical agitation with 1.25 mL of water and 2.5 mL of acetone for 1 hr. After adding 1.25 mL of a 20% NaCl solution, the mixture was then loaded onto a 5 mL Chem Elut SLE cartridge. After waiting for 15 min, analytes were eluted by gravity twice with 10 mL of ethyl acetate. Extracts were evaporated to dryness under a gentle stream of nitrogen and 200  $\mu$ L transferred to an acetonitrile-water solution (10:90) in vials for LC-MS/MS analysis. The extracts were analyzed by LC-MS/MS in the ESI mode without further purification. The 17 pesticides were separated by optimizing the LC gradient. The co-eluted pesticides with different masses were identified using the MRM mode.

**Figure 7.5** shows a comparison between recoveries obtained after SLE on Chem Elut and classical LLE. The comparison showed that the SLE extraction procedure provided similar or higher extraction efficiency than LLE for most compounds. Note in particular the surprisingly poor recovery results for Ch, Ri, and TOH for the LLE. For the SLE method, linearity was demonstrated from the range of 0.1-20 ng/g of raw honey with correlation coefficients ranging from 0.921 to 0.999 depending on the pesticide. Recovery rates were well above the range specified in the official methodology<sup>9</sup>. Reproducibility was found to be between 8 and 27%, acceptable within the concentrations studied. Over 100 samples of raw honey were analyzed to test the method robustness. More details on the method can be obtained in reference 11.

Figure 7.5

### Comparison of Recovery of Pesticides: LLE vs SLE



### Pesticides and Their Levels in Recovery Study

Pesticide Name	Abbreviation Used	Level (ng mL <sup>-1</sup> )	Pesticide Name	Abbreviation Used	Level (ng mL <sup>-1</sup> )
Amidosulfuron	Am	0.4	Linuron	Li	2.0
Atrazine	At	0.4	Methiocarb	Mh	10.0
Carbofuran	Ca	0.4	Methiocarb sulfoxide	MhS	20.0
Chlorotoluron	Ch	20.0	Metosulam	Mo	2.0
Diethofencarb	De	2.0	Pirimicarb	Pi	0.4
Dimethoate	Dm	2.0	Rimsulfuron	Ri	0.4
Fipronil	Fi	10.0	Simazine	Si	2.0
Imidacloprid	Im	2.0	2-Hydroxyterbuthylazine	TOH	1.0
Isoxaflutole	Is	2.0			

# Techniques Related to LLE

The technique of liquid-liquid extraction (LLE) is still among the most popular in routine sample preparation. Classical LLE uses copious amounts of solvent that are often hazardous and it is time-consuming to perform. Recently, there has been a developing interest in miniaturization of analytical methods with resultant solvent and sample savings; newer miniaturized approaches to liquid extraction have been reported. Compared to classical LLE, these approaches have resulted in more efficient sample enrichment, more rapid sample preparation, and easier automation.

## Microextraction

Microextraction is another form of LLE in which extractions are performed with the organic:aqueous phase ratio values in the range of 0.001-0.01. Using comparatively small volumes of organic solvent decreases analyte recovery, but the analyte concentration in the organic phase is greatly enhanced. In addition, solvent usage is greatly reduced. The extractions are carried out in volumetric flasks. The organic solvent is chosen to have a lower density than water so that this small volume of organic solvent accumulates in the narrow neck of the flask for convenient removal. The salting out effect can be used to enhance analyte concentration in the organic phase. Internal standards should be used and extractions of calibration standards performed along with the samples. Remember, as discussed in Mutual Phase Solubility, in order to ensure that the extraction solvents are saturated with the opposite solvent, the organic and aqueous solvents should be equilibrated with each other before placing the sample into the flask.

A new variation of microextraction, called dispersive liquid-liquid microextraction (DLLME) has been successfully applied to a variety of analyte-matrix pairs<sup>11</sup>. The technique is based on a three-component solvent system. In DLLME, the container is usually a centrifuge tube and the appropriate mixture of immiscible organic extraction solvent (usually a few microliters such as ~8  $\mu$ L of tetrachloroethylene) and a dispersive solvent (e.g. ~1 mL of acetone) is rapidly injected into an aqueous solution (approximately 5 mL), containing the analytes of interest, with a syringe (see **Figure 7.6**). The role of the dispersive solvent is to ensure miscibility between the organic phase and the aqueous phase. When the solvents are rapidly mixed, a cloudy solution is formed, consisting of fine particles (droplets) of extraction solvent which is entirely dispersed into the aqueous phase. Since the solution is already finely dispersed, no vigorous shaking is required. Extraction time is almost instantaneous and much faster than solid phase microextraction (SPME) and liquid phase microextraction (LPME), which often can require 30 min or longer. Next, the entire mixture is centrifuged (1.5 min at 6000 rpm), resulting in sedimentation of fine droplets of organic extraction solvent. They are subsequently removed with a microsyringe or micropipette. The organic solution containing the analyte of interest can be directly injected or evaporated and taken up in a more appropriate solvent for the chromatographic technique. In the original work<sup>11</sup>, the authors were able to achieve enrichment values of approximately 600-1100 for polynuclear aromatic hydrocarbons from a water sample with excellent recoveries. For further reading, a review article<sup>12</sup> is recommended.

Figure 7.6

## Workflow for Traditional DLLME

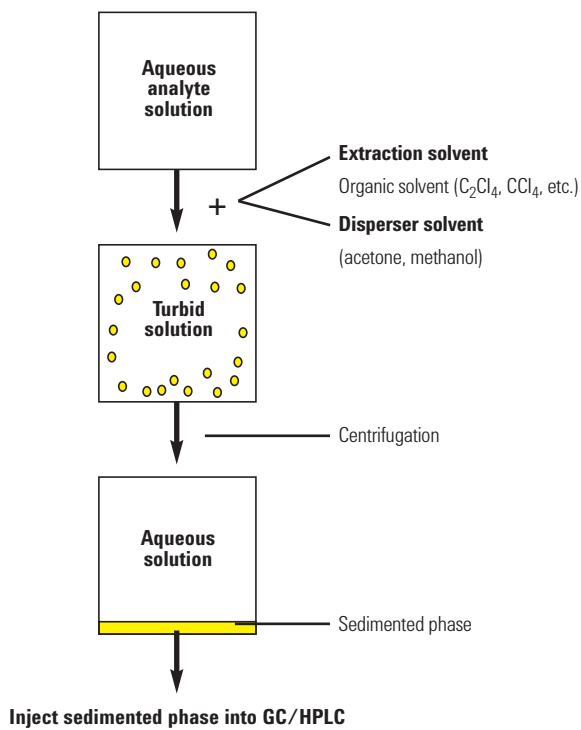

(Courtesy of Jared Anderson, U. Toledo)

An example of an application of DLLME by Caldas and coworkers<sup>13</sup> was able to show excellent extractions of pesticides (carbofuran, clomazone, and tebuconazole) in aqueous samples using DLLME along with LC-MS/MS analysis. In their work, they found that a 60  $\mu\text{L}$  portion of extraction solvent (carbon tetrachloride), 2 mL of dispersive solvent (acetonitrile) for a 5 mL sample of fortified water acidified with phosphoric acid at pH 2.0 gave the best results. Since acetonitrile was too strong of a solvent for their LC column, they evaporated the solvent to dryness and dissolved the residue in HPLC grade methanol. The variables in DLLME method development included: choice of dispersion solvent (**Figure 7.7**) and its volume, choice of extraction solvent and its volume (**Figure 7.8**), pH (if necessary), and centrifuge speed. For all three pesticides, the linear range was found to be 0.001-1.0 mg/L and the limit of quantitation (LOQ) was 0.02 mg/L. Overall, the DLLME technique is simple, fast, provides good recovery, is low cost, and provides good enrichment factors.

Figure 7.7

**Comparison of Dispersive Solvents in DLLME of Pesticides**

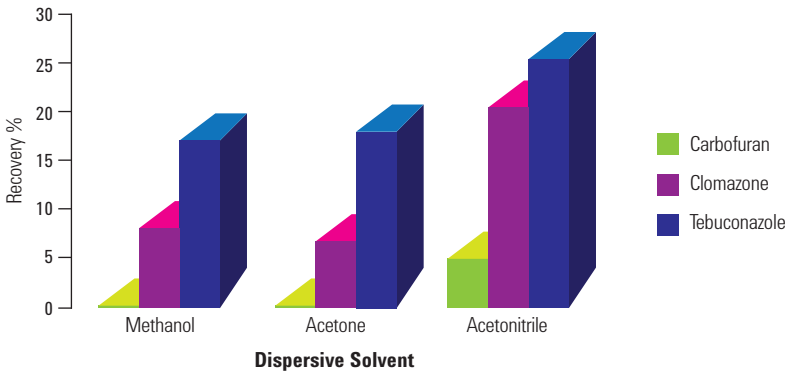
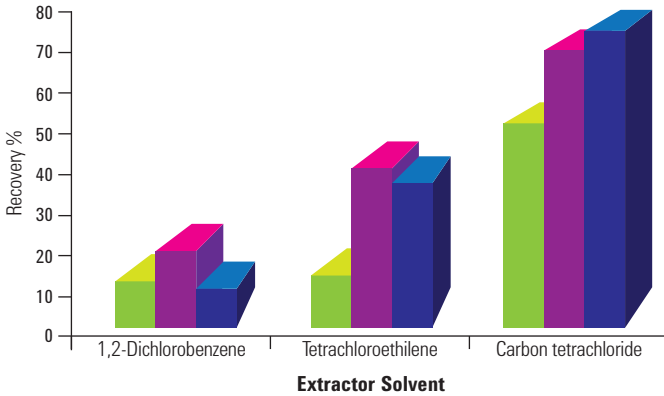

Figure 7.8

**Comparison of Extraction Solvents in DLLME of Pesticides**



## Single Drop Microextraction (SDME)

The simplicity and relatively low cost of solid phase microextraction (SPME), developed by Pawliszyn and co-workers<sup>15</sup> in 1990, has made it a popular sampling and sample preparation technique for gas chromatography, and to a lesser extent, for liquid chromatography (see Chapter 10, *Solid Phase Microextraction*). In SPME, a fiber coated with a stationary phase is placed into a solution or headspace and analytes diffuse and/or are moved by convection into the stationary phase. The concentrated analytes are transferred to the chromatography column by thermal desorption (GC) or liquid extraction (LC). The popularity of the technique has spurred the development of similar technologies.

One such technology termed "single drop microextraction" (SDME) describes a configuration where a droplet of solvent contained at the end of a PTFE rod or GC syringe needle replaces the coated fiber. The analytes diffuse into this droplet in a similar manner as the SPME fiber. The original work first described by Cantwell and Jeannot<sup>15</sup> was based on the experiments of Liu and Dasgupta<sup>16</sup>. The latter investigated gas molecules partitioning into liquid droplets.

Single drop microextraction has also been referred to as solvent microextraction, liquid phase microextraction, and liquid-liquid microextraction. In the original experiments of Cantwell and Jeannot<sup>16</sup>, the droplet size was 8  $\mu\text{L}$  of an immiscible organic solvent (n-octane) contained in a rod-shaped PTFE probe hollowed out at one end. The probe was immersed in an aqueous sample contained in a 1 mL vial that was agitated with a magnetic stirrer. Since the 8  $\mu\text{L}$  volume was too large to directly inject into a GC, the authors took an aliquot that limited sensitivity. However, in their next publication<sup>17</sup> as well as the similar work of He and Lee<sup>19</sup>, the droplet size was reduced to 1-2  $\mu\text{L}$  by using the tip of a GC syringe needle as the drop holder. The entire droplet was then injected into the GC. A schematic of the single drop microextraction experiment is shown in **Figure 7.9**.

Figure 7.12

### Experimental Setup for SDME

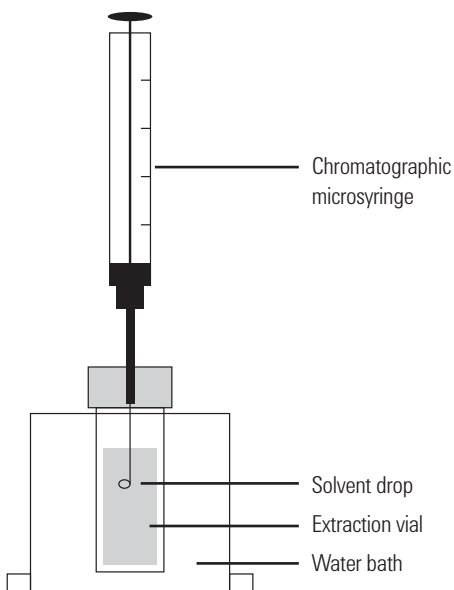

In the SDME there are a few experimental parameters that should be precisely controlled in order to have reproducible results. Similar to SPME, the partition equilibrium is not reached during the procedure, so precise timing is essential for good reproducibility. Cantwell and Jeannot<sup>15</sup> found that they could achieve relative standard deviations in the 1.5 percentile, even when the extraction was only 38% of the way to equilibrium. Note that enrichment factors are generally less than 100 in the SDME experiment. **Table 7.3** lists some of the organic solvents that have been successfully applied to SDME.

### Experimental Setup for Headspace-SDME

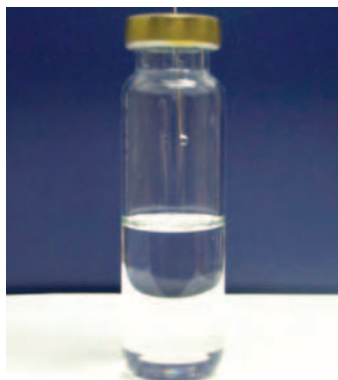

Table 7.3

#### Typical Extracting Solvents for SDME

n-Hexane
n-Octane
i-Octane
Cyclohexane
n-Hexadecane
Toluene
Chloroform
Butylacetate
Diisopropyl ether



The techniques of SDME to SPME were compared for the analysis of trace organic pollutants<sup>19</sup> and nitroaromatic explosives<sup>20</sup> from aqueous samples. In summary, the authors found that the techniques are comparable in terms of precision and analysis time. The small amount of solvent used in SDME is an advantage and the use of various solvents or solvent mixtures allows some degree of selectivity in the extraction of different organic species. In SPME, selectivity is governed by the selection of the polymeric coating on the fiber. In contrast to the rapid solvent evaporation of SDME, thermal desorption in SPME (desorption from the polymer in a hot injector) is a slow process and resulting peaks may tail. While SPME fibers must be replaced occasionally, SDME uses only standard syringes. Sometimes the stirring or sonication of samples in SDME can cause problems with the suspended drop. A static or dynamic extraction could be employed as an alternative approach. If the droplet is too large, it can be dislodged from the syringe tip when stirring. Unlike SPME, the liquid organic drop in SDME may dissolve slightly in the aqueous sample. This dissolution is dependent on the aqueous solubility of the solvent used for extraction. The longer the extraction time, the more the droplet size decreases. Most of the extraction experiments are less than 15 minutes and as a result, dissolution may not be a problem. Additionally, some care must be taken to avoid carryover in the syringe needle.

One advantage of SDME is that the extracted sample contained in a small volume (1 or 2  $\mu\text{L}$ ) of organic solvent could potentially be injected directly into an HPLC injector. Interfacing SPME to HPLC involves a complex instrumental arrangement. The rate of dissolution of many analytes from the SPME fiber is quite slow resulting in initial band spreading during the displacement to the HPLC column. A publication described single drop liquid phase microextraction followed by HPLC for the analysis of hypercins in deproteinated plasma and urine<sup>21</sup>. Rather than attempting to inject the droplet directly into an HPLC injector, the authors transferred the droplet to a microvial and diluted the sample to 30  $\mu\text{L}$  with an aqueous compatible solvent (methanol) for injection into a reversed-phase HPLC column.

In Chapter 6, the technique of Headspace-SDME was introduced. Similar to Headspace-SPME, the fiber is replaced by a microdrop at the base of a syringe needle and the drop is exposed to the headspace of a solid- or liquid-sample in a vial or other closed container. At the right hand side of Figure 7.9, the experimental setup for Headspace-SDME is depicted. The reader is referred to Chapter 6 to get more details of the technique.

## Flow Injection Extraction (FIE)

The FIE technique was first described by Karlberg and Thelander<sup>22</sup> and was designed to overcome the disadvantages of conventional liquid-liquid extraction. In FIE, an aqueous sample is injected into an aqueous flowing stream. Segments of immiscible organic solvent are then continuously inserted into this stream. After the segmented streams pass through a coil in which the partitioning occurs, the organic phase is then separated from the aqueous phase and directed to a flow-through cell for measurement. In some cases, air segments are introduced between segments to allow the smooth solvent passage without undue mixing. Systems have also been developed where final phase separation is not necessary. Compared to conventional LLE, the amount of solvent used in FIE is greatly reduced to several hundred microliters per analysis. The technique has been applied extensively in on-line trace enrichment of metal ions when coupled to atomic absorption or inductively-coupled plasma spectrometers. Other continuous flowing liquid-liquid extraction techniques appear to have more appeal and provide enhanced enrichment factors.

## Other Techniques Involving LLE Concepts

There has been an increasing interest in combining porous membranes of different configurations (e.g. hollow fiber, cylindrical, and flat) with the various liquid-liquid extraction techniques. The polymer-based membranes serve as a barrier between the sample and the extraction solvents. Only certain species are allowed to pass through the membrane pores resulting in increased selectivity in extractions. These techniques will be thoroughly described in Chapter 18, which is devoted to the use of membranes in sample preparation.

QuEChERS and related salting out extractions have recently gotten a great deal of attention, especially for the extraction of pesticides from fruit and vegetable samples.

The QuEChERS technique combines liquid-liquid extraction with dispersive solid phase extraction, somewhat different than classical LLE approaches outlined in this chapter. Chapter 8 will be devoted to QuEChERS and other salting out techniques for sample extractions.

## References

---

1. Snyder, L.R. *J. Chromatogr. Sci.* **1978**, *16*, 223.
2. Snyder, L.R.; Kirkland, J.J.; Dolan, J.W. *Introduction to Modern Liquid Chromatography*, 3rd Ed., Chapter 2 and Appendix I.2, John Wiley and Sons, Hoboken, NJ, **2010**.
3. Snyder, L.R. *Chemtech* **1979**, *9*, 750.
4. Snyder, L.R. *Chemtech* **1980**, *10*, 188.
5. Ma T.S.; Horak, V. *Microscale Manipulations in Chemistry*, Wiley, New York, **1976**.
6. Mandava N.B.; Ito, Y. (Eds.) *Countercurrent Chromatography: Theory and Practice*, Dekker, New York, **1988**.
7. Riddick, J.D.; Bunger, W.B. *Organic Solvents*, Wiley-Interscience, New York, **1970**.
8. Pirard, C. *Mass Spectrometry Laboratory*, University of Liege, Belgium, published in Agilent Technologies Application Note Si-01002, **August 2010**.
9. REF: Commission Decision 2002/657/EC, Off. *J. Eur. Commun.* **August 12, 2002**.
10. Pirard, C.; Widart, J.; Nguyen, B.K.; Deleuze, C.; Heudt, L.; Haubruge, E.; De Pauw, E.; Focant, J.-F. *J. Chromatogr. A* **2007**, *1152* (1-2), 116-123.
11. Rezaee, M.; Assadi, Y.; Hosseini, M.-R. M.; Aghaee, E.; Ahmadi, F.; Berijani, S. *J. Chromatogr. A* **2006**, *16*, 1-9.
12. Rezaee, M.; Yamini, Y.; Faraji, M. *J. Chromatogr. A* **2010**, *1217*, 2342-2357.
13. Caldas, S.S.; Costa, F.P.; Primel, E.G. *Anal. Chim. Acta* **2010**, *665* (1), 55-62.
14. Arthur, C.L.; Pawliszyn, J. *Anal. Chem.* **1990**, *62*, 2145.
15. Jeannot, M.A.; Cantwell, F. F. *Anal. Chem.* **1996**, *68*, 2236-2240.
16. Liu, S.; Dasgupta, P.K. *Anal. Chem.* **1995**, *67*, 2042-2049.
17. Jeannot, M.A.; Cantwell, F.F. *Anal. Chem.* **1997**, *69*, 235-239.
18. He, Y.; Lee, H.K. *Anal. Chem.* **1997**, *69*, 4634-4640.
19. Buszewski, B.; Ligor, T. *LCGC Europe* **2002**, *15* (2), 92-97.
20. Psillakis, E.; Kalogerakis, N. *J. Chromatogr. A* **2001**, *938* (1-2), 113-120.
21. Gioti, E.M.; Skalkos, D.C.; Fiamegos, Y.C.; Stalikas, C.D. *J. Chromatogr. A* **2005**, *1093*, 1-10.
22. Karlberg, B.; Thelander, S. *Anal. Chim. Acta* **1978**, *98*, 1-7.

# QuEChERS, Salting Out Liquid-Liquid Extraction, and Related Techniques

## Salting Out Extraction

Liquid-liquid extraction (LLE) has long been an effective method of separating compounds having different solubilities in two immiscible liquids (see Chapter 7). The two liquids are typically water, perhaps with some additives or pH adjusted, and a non-polar organic solvent, such as isooctane or ethyl acetate. Typically, polar compounds prefer the aqueous layer while non-polar compounds are extracted into the organic layer. A drawback of the use of non-polar, water-immiscible organic solvents is, due to their low dielectric constants, they are relatively poor at the extraction of very polar or highly charged solutes, particularly for highly water-soluble pharmaceuticals that may require extractions at very low or very high pH values. More polar solvents, such as acetonitrile that provides solubility for these more polar compounds, are frequently water-miscible and thus cannot be used for conventional LLE.

It has long been known that the addition of an inorganic salt into a mixture of water and a water-miscible organic solvent causes a separation of the solvent from the mixture and the formation of a two-phase system<sup>1</sup>. Observations of this “salting out” phenomenon were made for a number of water-miscible organics such as acetone, methanol, ethanol, and acetonitrile. Different salts caused different degrees of phase separation. The high polarity, water-miscible solvents used in salting out systems have been investigated for extraction or concentration of many analytes that cannot be extracted by conventional LLE solvents. This salting out effect usually occurs at high salt concentrations. In some cases, the “salting out” (or perhaps better termed as “sugaring out”) effect can also be achieved with high concentrations of saccharides<sup>2</sup>. Since extracts are not particularly clean, relative to other sample preparation procedures, this simple extraction process is especially useful when very selective detection is used in GC or HPLC.

Salting out extraction has been used for the preconcentration of neutral polar organics from water. Leggett and coworkers showed that high recoveries of trace explosive compounds can be achieved from water using acetonitrile/NaCl salting out extraction<sup>3</sup>. They initially tried conventional LLE with methylene chloride as an extraction solvent, and for some nitroamines such as HMX and RDX, extraction efficiency was rather poor. Addition of sodium chloride to the water improved the situation a bit, but the salting out extraction with acetonitrile gave the greatest overall recoveries. In fact, the U.S. Environmental Protection Agency Method 8330A for the isolation of nitroaromatic and nitramine explosives from water at the ng/L level is based on a salting out extraction method<sup>4</sup>. The method involves the addition of 251 g of sodium chloride to a 1 L volumetric flask containing 770 mL of water sample. The addition of 164 mL of acetonitrile with stirring is followed by a phase separation step. Removal of the acetonitrile upper layer is followed by some additional small volume extractions and a back extraction. Finally, an aliquot is injected into a reversed-phase HPLC column with a further confirmation on a cyano column.

Extractions using the salting out effect began to be used more extensively in the area of pesticide analysis. First, non-ionic pesticides in various vegetal food samples were extracted using water-miscible organic solvents like acetonitrile and methanol. The Luke method showed that acetone-water (65:35, v/v) could also be used for this purpose<sup>5</sup>. A multi-class, multiresidue method (MRM) was used by Mills and co-workers to extract non-polar pesticides from various food samples of vegetal origin using acetonitrile<sup>6</sup>. The addition of NaCl and water to the acetonitrile extract allowed partitioning into a very non-polar solvent, petroleum ether. The use of acetonitrile followed by salting out proved to be better suited for the extraction of non-polar and polar pesticides from vegetable samples and has been adopted today by several regulatory bodies<sup>7</sup>. However, the extracts were still rather "dirty".

In 1993, Anastassiades, Lehotay, and co-workers at the U.S. Department of Agriculture in Wyndmoor, PA<sup>8</sup> further refined the acetonitrile extraction by using NaCl salting out plus the addition of a drying agent ( $MgSO_4$ ) to remove the water and force the pesticides into the acetonitrile phase. Termed the "QuEChERS" technique (pronounced "catchers") standing for Quick, Easy, Cheap, Effective, Rugged, and Safe, has quickly received widespread attention since its development<sup>9</sup>. The QuEChERS technique will be covered on the following pages.

# QuEChERS, A Simple Yet Effective Extraction Technique

Since its inception in 2003, the QuEChERS technique has grown in popularity, especially for the sample cleanup for the multi-class, multiresidue analysis of pesticides in fruits and vegetables. The technique has expanded beyond these traditional samples to include meat products, fish, blood, and even soil. The simple two-step extraction technique is based on salting out extraction followed by dispersive solid phase extraction (dSPE) cleanup. Although NaCl was used for salting out in the original QuEChERS method<sup>8</sup>, refinements were made when it was discovered that some base-sensitive compounds, such as the fungicides chlorothalonil and captan, gave poor recovery. This discovery led to the development of two buffered methods for the initial extraction step. One new method uses a 1% acetic acid/sodium acetate buffer, rather than NaCl<sup>10</sup> and forms the basis for the American Association of Analytical Chemists (AOAC) QuEChERS 2007.01 Method<sup>11</sup>. The second new method, EN-15662 EU Method uses a weaker buffering system consisting of 1 g sodium citrate and 0.5 g disodium citrate sesquihydrate (pH 5.5) and, in most cases, is equally effective as the AOAC Method<sup>12</sup>. There are slight variations in the two extraction methods, such as slightly different sample weights, solvent volumes, etc.

Following the acetonitrile extraction step, the introduction of a dSPE step, in which a portion of the raw extract is mixed with bulk SPE sorbent such as C18, primary-secondary amine (PSA), and graphitized carbon that helps to further clarify the extract, and after centrifugation, allows the supernatant to be injected directly into a GC/MS, LC/MS, or MS/MS system. In dSPE, the sorbent is chosen to retain the matrix and undesired components and to allow the analyte(s) of interest to remain in the liquid phase. This is the opposite from the normal mode of operation of solid phase extraction bind-elute method (see Chapter 9) where the sorbent is chosen to retain the analytes of interest and not the matrix.

Hundreds of pesticide residues in a wide variety of fruits and vegetables are now isolated routinely using QuEChERS cleanup. Although one can easily assemble the necessary materials from a general laboratory catalog to perform QuEChERS, many users prefer to buy pre-packaged kits. Most companies selling QuEChERS extraction products carry all three kits to cover the original unbuffered method, the AOAC Method, and the EU Method. These kits provide pre-weighed salts and dispersive SPE sorbents in the proper size centrifuge tubes. Some vendors, such as Agilent Technologies, provide specific dSPE kits depending on the nature of the fruit and/or vegetable sample (e.g. fatty vs highly pigmented matrices). Individual dSPE sorbents sold in bulk are available for those who would like to customize their QuEChERS experiments.

**Figure 8.1** shows how this simple procedure is performed.

Figure 8.1

## QuEChERS

### Step 1: Salting Out Extraction



1 Weigh sample



2 Add water and QC spikes if needed and spike with internal standard



3 Add acetonitrile



4 Vortex or shake

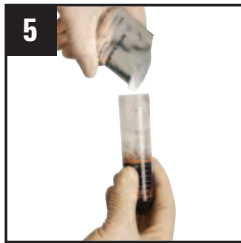

5 Add salt packet



6 Shake 1 minute



7 Centrifuge at 4000 rpm for 5 minutes

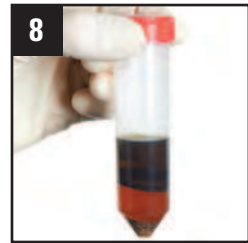

8 Phase separation of acetonitrile and aqueous layer

### Step 2: Dispersive Solid Phase Extraction (dSPE)

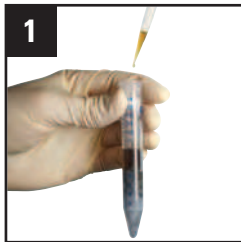

1 Choose the dispersive cleanup kit and add acetonitrile extract



2 Vortex for 1 minute

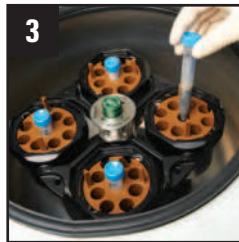

3 Centrifuge at 4000 rpm for 5 minutes



4 Take aliquot of supernatant and dry down or dilute as necessary



5 Place in autosampler vials for GC or LC analysis

## Initial Sample Preparation (Figure 8.1.1)

Into a 50 mL centrifuge tube, weigh a 10 g (AOAC) or 15 g (EN) portion of the homogenized sample. Because this sample mass is reduced compared to more traditional extraction approaches, it is of utmost importance to ensure that the original sample, that can be up to kilograms in weight, be extremely homogeneous. Thus, a powerful chopping device is recommended to homogenize the sample to maximize surface area and to ensure better extraction efficiency. Such a homogenization procedure would help to ensure that the 10 or 15 g subsample is representative of the original. To prevent loss of more volatile pesticides during the homogenization step, two additional steps are recommended: pre-freezing chopped samples and dry ice addition. Since water is one of the two solvents used in the initial extraction procedure, there must be a presence of water at this point of the experiment. Many fruit and vegetable samples contain between 80-95% water, which is required for the partitioning to take effect. For dry samples such as beans or grain, an appropriate portion of water should be added.

## Extraction – Partitioning Solvent (Figure 8.1.2)

Next, 10 mL (EN Method) or 15 mL (AOAC Method ACN) is added to the centrifuge tube containing the solid sample. Although other non-halogenated solvents such as acetone and ethyl acetate may be used, acetonitrile is the recommended solvent for QuEChERS because, upon the addition of salts, it is separated more easily from water than acetone. The polarity of acetonitrile is higher than that of acetone and ethyl acetate. According to “like dissolves like” theory, the medium to high polarity pesticides have much better solubility in acetonitrile than in the other two solvents. As a result, the extraction recoveries of polar pesticides are significantly improved by the use of acetonitrile.

Ethyl acetate has the disadvantages of: 1) a partial miscibility with water (but it could extract lipids and waxes); 2) lower recoveries for acid/base pesticides; and 3) provides less cleanup in dSPE. However, acetonitrile extracts less of the lipophilic materials. Compared to acetone, the use of acetonitrile allows for better removal of residual water with magnesium sulfate. It is compatible with HPLC mobile phases and GC applications, although it tends to give a relatively large solvent expansion volume during sample vaporization in the GC inlet, interferes with nitrogen specific GC detectors, and is less volatile than other common GC solvents. Thus, if evaporative concentration steps are required for HPLC solvent reconstitution, or for an increase in concentration (of non-volatiles, of course), the process is more time-consuming. Prior to the addition of salt (**Figure 8.1.4**), the sample-acetonitrile mixture is shaken to wet the entire sample (**Figure 8.1.3**). This process will also prevent potential labile pesticide loss due to temporary heat produced when the salts are added (in the next step).



## Addition of Salts (Figure 8.1.4)

The purpose of salt addition is to induce phase separation. The salting out effect also influences analyte partition, which is dependent on the solvent used for extraction. The concentration of salt can influence the percentage of water in the organic phase and can adjust its "polarity". In QuEChERS, acetonitrile alone is usually sufficient to achieve excellent extraction efficiency without the need to add non-polar co-solvents that dilute the extract and make them too non-polar. In some cases, the pH of the extraction must be controlled.

Most, but not all, pesticides are more stable at lower pH values. For certain problematic pesticides, such as those that are strongly protonated at low pH, the extraction system must be buffered in the pH range 2-7 for successful extractions<sup>13</sup>. Of course, the pH at which the extraction is performed can also influence the co-extraction of matrix compounds and pesticide stability. For this step, it is important that the salt be added after the acetonitrile-sample mixture is shaken. If the sample is added to the salt mixture, exothermic heating may occur which could cause loss of volatile pesticides or cause degradation of labile pesticides. For the salt addition, handy pre-weighed, pourable packets of the appropriate composition of a salt mixture (anhydrous, packed under nitrogen) are commercially available. It is advisable to avoid using salt pre-filled centrifuge tubes due to this localized heating effect.

## Internal Standard Addition (Figure 8.1.2 and Figure 8.1.5)

To minimize error generation in the multiple steps of the QuEChERS method, an internal standard is often added somewhere in the process, sometimes earlier in the salting out extraction step. In the original development work, the authors<sup>8</sup> used triphenylphosphate (TPP), which had the right properties to undergo quantitative extraction from low-fat matrices. However, it was later found that the use of more than one internal standard as a quality control measure enable recognition of errors due to mis-pipetting or discrimination during partitioning or cleanup<sup>14</sup>. After shaking the sample- internal standard-acetonitrile-salt mixture for 1 min, the centrifuge tube is placed in a centrifuge (**Figure 8.1.6**) and spun for 5 min at 4,000 rpm to ensure phase separation and to allow excess salts and matrix to be separated from the supernatant liquid (**Figure 8.1.7**).

To aid in the thorough mixing between the solids and the liquid phases, and to cut down on the shaking time, the use of Agilent ceramic homogenizers in the 50 mL centrifuge tube during the initial extraction step is recommended. These inert, non-porous, solid rods have an angled cutting surface that helps to ensure that there is intimate contact with the sample and extraction chemicals and helps to break up salt agglomerates, if any are present. They have been shown to cut the shaking time considerably<sup>15</sup> and reduce variance between people, since manual shaking by hand can be a variable in the QuEChERS process. The RSDs were found to be improved.

## dSPE (Figure 8.1.8)



Traditionally, SPE cleanup uses plastic cartridges containing various amounts of sorbent material. In dSPE, an aliquot of sample extract (for example, 1, 6, or 8 mL) is added to a vial containing a small amount of SPE sorbent (**Figure 8.1.8**) and the mixture shaken by hand (1 min) or mixed on a vortex mixer to evenly distribute loose SPE material and facilitate the cleanup process. The sorbent is then separated by centrifugation (**Figure 8.1.9**), an aliquot of the supernatant (**Figure 8.1.10**) is subjected to analysis (**Figure 8.1.11**). The sorbent is chosen to retain matrix components, and not the analytes of interest. In some cases, mixed sorbents can be used. For samples with a high fat matrix, primary-secondary amine (PSA) mixed with C18 sorbent is recommended. For samples with high levels of chlorophyll and carotenoids (for example, spinach, and carrots), PSA is mixed with graphitized carbon black to reduce these colored compounds. Although the addition of graphitized carbon black helps with the removal of pigment, there is an accompanying low recovery of certain structurally planar pesticides, such as Carbendazim and Cyprodinil. The planar pesticide recoveries can be increased by the addition of toluene in the extraction step<sup>16</sup>. Newer sorbents that remove chlorophyll without adsorbing planar pesticides have become available.

**Table 8.1** provides some guidance on how to match the dSPE sorbent with the fruit and vegetable sample matrix based on sample matrix: fat content, waxiness, and the presence and level of pigments. For convenience, the Agilent part numbers for the various QuEChERS dSPE kits are provided.

Table 8.1

## Selection of dSPE Sorbent Based on Food Matrix



### QuEChERS Dispersive Kits, Fruits and Vegetables

Kit	Size	Unit	AOAC 2007.01 Method	European Method EN 15662
			Kit Contents Part No.	Kit Contents Part No.
 <p><b>General fruits and vegetables:</b> Removes polar organic acids, some sugars and lipids</p>	2 mL	100/pk	50 mg PSA 150 mg MgSO <sub>4</sub> 5982-5022 5982-5022CH	25 mg PSA 150 mg MgSO <sub>4</sub> 5982-5021 5982-5021CH
	15 mL	50/pk	400 mg PSA 1200 mg MgSO <sub>4</sub> 5982-5058 5982-5058CH	150 mg PSA 900 mg MgSO <sub>4</sub> 5982-5056 5982-5056CH
 <p><b>Fruits and vegetables with fats and waxes:</b> Removes polar organic acids, some sugars, more lipids and sterols</p>	2 mL	100/pk	50 mg PSA 50 mg C18EC 150 mg MgSO <sub>4</sub> 5982-5122 5982-5122CH	25 mg PSA 25 mg C18EC 150 mg MgSO <sub>4</sub> 5982-5121 5982-5121CH
	15 mL	50/pk	400 mg PSA 400 mg C18EC 1200 mg MgSO <sub>4</sub> 5982-5158 5982-5158CH	150 mg PSA 150 mg C18EC 900 mg MgSO <sub>4</sub> 5982-5156 5982-5156CH
 <p><b>Pigmented fruits and vegetables:</b> Removes polar organic acids, some sugars and lipids, and carotenoids and chlorophyll; not for use with planar pesticides</p>	2 mL	100/pk	50 mg PSA 50 mg GCB 150 mg MgSO <sub>4</sub> 5982-5222 5982-5222CH	25 mg PSA 2.5 mg GCB 150 mg MgSO <sub>4</sub> 5982-5221 5982-5221CH
	15 mL	50/pk	400 mg PSA 400 mg GCB 1200 mg MgSO <sub>4</sub> 5982-5258 5982-5258CH	150 mg PSA 15 mg GCB 885 mg MgSO <sub>4</sub> 5982-5256 5982-5256CH

Part numbers ending in CH indicate tubes containing ceramic homogenizers.

(Continued)

## QuEChERS Dispersive Kits, Fruits and Vegetables

Kit	Size	Unit	AOAC 2007.01 Method	European Method EN 15662
			Kit Contents Part No.	Kit Contents Part No.
 <p><b>Highly pigmented fruits and vegetables:</b> Removes polar organic acids, some sugars and lipids, plus high levels of carotenoids and chlorophyll; not for use with planar pesticides</p>	2 mL	100/pk		25 mg PSA 7.5 mg GCB 150 mg MgSO <sub>4</sub> 5982-5321 5982-5321CH
	15 mL	50/pk		150 mg PSA 45 mg GCB 855 mg MgSO <sub>4</sub> 5982-5356 5982-5356CH
 <p><b>Fruits and vegetables with pigments and fats:</b> Removes polar organic acids, some sugars and lipids, plus carotenoids and chlorophyll; not for use with planar pesticides</p>	2 mL	100/pk	50 mg PSA 50 mg GCB 150 mg MgSO <sub>4</sub> 50 mg C18EC 5982-5421 5982-5421CH	
	15 mL	50/pk	400 mg PSA 400 mg GCB 1200 mg MgSO <sub>4</sub> 400 mg C18EC 5982-5456 5982-5456CH	

Part numbers ending in CH indicate tubes containing ceramic homogenizers.

(Continued)

### QuEChERS Dispersive Kits: Other Food Methods

<b>Other Food Methods</b>	2 mL	100/pk	25 mg C18
Removes biological matrix interferences, including hydrophobic substances (fats, lipids) and proteins			150 mg MgSO <sub>4</sub> 5982-4921 5982-4921CH
	15 mL	50/pk	150 mg C18 900 mg MgSO <sub>4</sub> 5982-4956 5982-4956CH
<b>All Food Types</b>	2 mL	100/pk	50 mg PSA 50 mg C18 7.5 mg GCB 150 mg MgSO <sub>4</sub> 5982-0028 5982-0028CH
Removes all matrix interfering materials including polar organic acids, lipids, sugars, proteins, carotenoids and chlorophyll			
	15 mL	50/pk	400mg PSA 400 mg C18 45 mg GCB 1200 MgSO <sub>4</sub> 5982-0029 5982-0029CH
<b>Animal Origin Food</b>	15 mL	50/pk	50 mg PSA 150 mg C18EC 900 mg Na <sub>2</sub> SO <sub>4</sub> 5982-4950
Removes matrix interferences such as polar organic salts, sugars, lipids and proteins			

Part numbers ending in CH indicate tubes containing ceramic homogenizers.

## “Analyte Protectants” (Optional):

An optional step, mainly used for GC analysis, is found to be very useful for pesticides that are unstable at intermediate pH values and for sensitive analytes that behave poorly in the GC system, such as response loss, peak tailing, etc. due to GC flow path surface activities, including active sites on inlet liners, GC capillary column and other interior surfaces. In this case, analyte protectants are added to the extracts before sample injection into the GC system. The protectants compounds do not interfere with the analysis of pesticides of interest yet they will reduce the interactions of these sensitive pesticides with the GC flow path active sites, thus protecting these pesticides from poor chromatographic performance. Thorough studies were devoted to selecting the appropriate analyte protectants<sup>17-18</sup>. The results demonstrated that errors in GC analysis caused by matrix effects were also reduced dramatically with the help of the analyte protectants. Of course, with LC and LC/MS, the protectants are not recommended.

## Analysis

After centrifugation (**Figure 8.1.9**), and ensuring that any sorbent or excess salts are not in the supernatant, the sample aliquot from the dSPE step can be injected directly into a GC or HPLC system without further workup. For LC/MS analysis, it might be necessary to dilute properly with acidic water to provide MS chromatographic integrity. For GC/MS analysis, if the instrument is not equipped with a programmable temperature vaporizer, evaporation of the supernatant with reconstitution in a GC-compatible solvent might be needed. In general, extracts from the simple QuEChERS process are not as clean as from other more work-intensive sample preparation procedures such as SPE. Thus, the use of selective detection is highly recommended.

## Applications of QuEChERS

Although the main emphasis of the QuEChERS approach has been the analysis of pesticides in foods and other agricultural products, the range of applications is expanding greatly. **Table 8.2** lists typical published applications of different analytes and different matrices that show the versatility of this growing sample preparation technique.

Table 8.2

<b>Selected QuEChERS Application Notes</b>		
<b>Analyte(s)</b>	<b>Matrix</b>	<b>Reference Agilent Application Note</b>
Acrylamide	Cooking oil	5990-8988EN
	French fries	5990-5940EN
Amino acids	Spinach, apples	J.W. Henderson, T. Faye, U. Wittek, and J. Stevens, poster paper presented at RAFA 2009, Prague, Czech Republic
Hormones	Shrimp	5990-6589EN
PAHs	Fish	5990-5441EN, 5990-4248EN, 5990-6668EN, 5990-7908EN, 5990-7714EN
	Soil	5990-5452EN (AOAC), 5990-6324EN 5990-6324EN, 5990-5452EN
PCBs	Fish	5990-6263EN, 5990-7908EN, 5990-7714EN
Pesticides	Apple	5990-4468EN, 5990-6558EN, 5990-3937EN
	Rice	5990-8034EN
	Green tea	5990-6400EN
	Lemon oil	5990-6432EN
	Spinach	5990-4305EN (AOAC), 5990-4395EN, 5990-4247EN, 5990-4248EN, 5990-9317EN
	Lettuce	5990-6558EN
	Baby food	5990-5028EN
	White flour	5990-9317EN
	Pepper	
	Orange	
	Carrot	5990-Si-02213
	Green pepper	5990-8067EN, 5989-8614EN
	Cucumbers	5990-8067EN, 5990-6323EN
	Tomato	5990-8067EN, 5990-6323EN, 5989-8614EN
	Tea (green & black)	5990-9865EN
	Beans	Si-02213
	Avocados	Avocado_poster_EPRw2006.pdf
	Fish	5990-7908EN, 5990-7714EN, 5990-6595EN
	Olive oil	5990-5553EN, 5990-7722EN
	Strawberry	5990-7706EN, 5990-9317EN
Pear		
Banana		
Pharmaceuticals	Whole blood	5990-8789EN
Quinolone antibiotics	Bovine liver	5990-5085EN
Sulphonamide antibiotics	Bovine liver	5990-5086EN
	Chicken muscle	5990-5395EN
Veterinary drugs	Animal origin foods	5991-0013EN

To illustrate the application of this technique, we will show some results obtained for the extraction and analysis of 16 “representative” pesticides in apples using the AOAC methodology<sup>19</sup>. The representative list chosen by Lehotay et al<sup>20</sup> included nine different pesticide classes, including acidic, basic, neutral, base-sensitive, and acid-labile pesticides suitable for LC-MS/MS analysis. **Figure 8.2** illustrates the QuEChERS workflow used in this study.

Figure 8.2

### Workflow for Pesticides in Apple QuEChERS Extraction

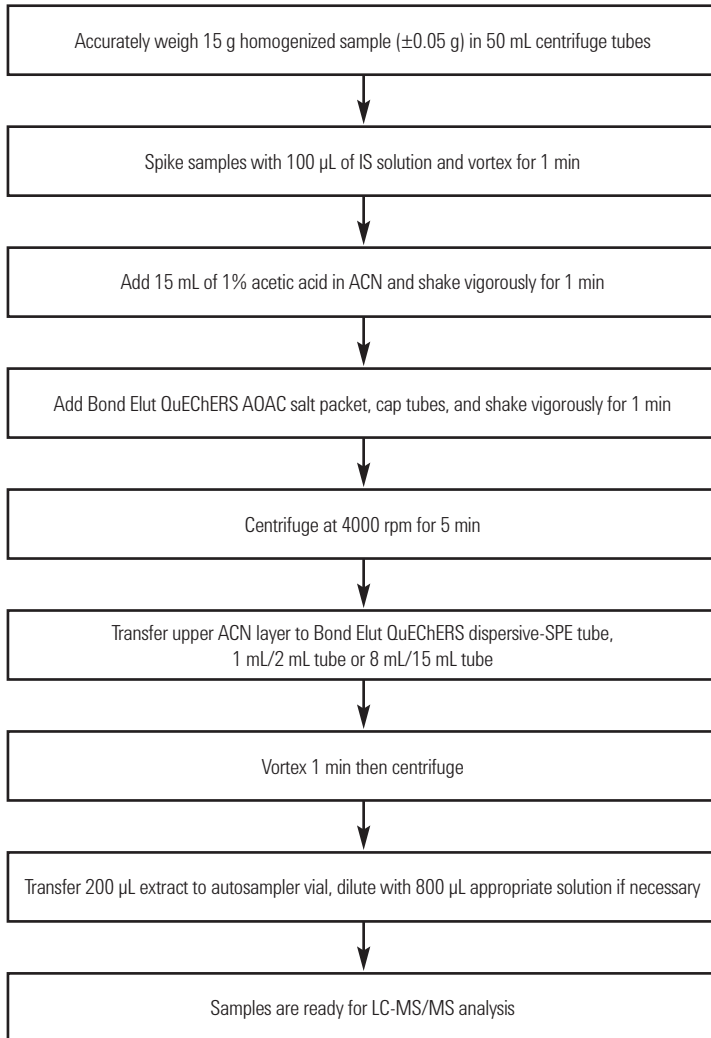



In order to get the most reliable statistical results, the initial sample preparation is an extremely important part of the QuEChERS process. A large enough sample must be used in order to obtain a representative portion and this large sample must be finely comminuted since only 15 g is required for the QuEChERS extraction. A 15 g sample of comminuted apple (from 3 pounds of organically grown apples) was placed into a 50 mL centrifuge tube and an internal standard added, followed by vortexing. Next, 15 mL of 1% acetic acid in acetonitrile was added followed by an Agilent AOAC Buffered Extraction packet containing 6 g of anhydrous  $\text{MgSO}_4$  and 1.5 g of anhydrous sodium acetate. As noted earlier, it is important to add the buffer salt after the addition of acetonitrile since the addition of salt is an exothermic reaction and can cause localized heating in the sample, potentially causing thermal decomposition. Next, the entire mixture was sealed tightly and shaken vigorously by hand followed by centrifugation. This operation represents the salting out extraction step. Acetonitrile forms a separate upper layer from the water layer that results from the apple matrix.

The next step was a further clarification using dSPE. A 1 mL aliquot of the upper acetonitrile layer was transferred into a 2 mL dispersive SPE tube containing pre-weighed 50 mg of primary secondary amine (PSA) and 150 mg of anhydrous  $\text{MgSO}_4$ . The tube was tightly capped, vortexed, and finally centrifuged. A 200  $\mu\text{L}$  aliquot was transferred to an autosampler vial and diluted with 800  $\mu\text{L}$  of water. The sample was then analyzed by LC-MS/MS.

The HPLC separation was performed by gradient reversed-phase chromatography on a phenyl-hexyl column. The operating conditions are given in reference 19. The LC-MS/MS chromatograms of an apple blank carried through the entire QuEChERS procedure is shown in **Figure 8.3A**. The final QuEChERS prepared sample will contain food matrix impurities because it is a simple sample extraction and cleanup procedure. With the powerful selectivity of LC-MS/MS operated in the multiple reaction monitoring (MRM) mode (see instrument data acquisition settings in reference 19), the extract apple blank did not contribute any interferences with the target compounds. **Figure 8.3B** shows the chromatogram of a 10 ng/g (10 ppb) fortified apple extract at the limit of quantitation (LOQ). This LOQ for the pesticides in apple shown was well below the maximum residue levels (MRLs). Even though some of the pesticide peaks showed poor chromatographic resolution, the selectivity of electrospray ionization tandem mass spectrometry permitted the accurate quantitation. Mean recoveries ranged between 76-117% (95.4% on average) with RSD values below 15% (4.3% on average). Such values are acceptable when performing trace pesticide analysis in food matrices.

Figure 8.3

## LC-MS/MS Chromatograms of Blank Apple Extract and Spiked Pesticide Extract

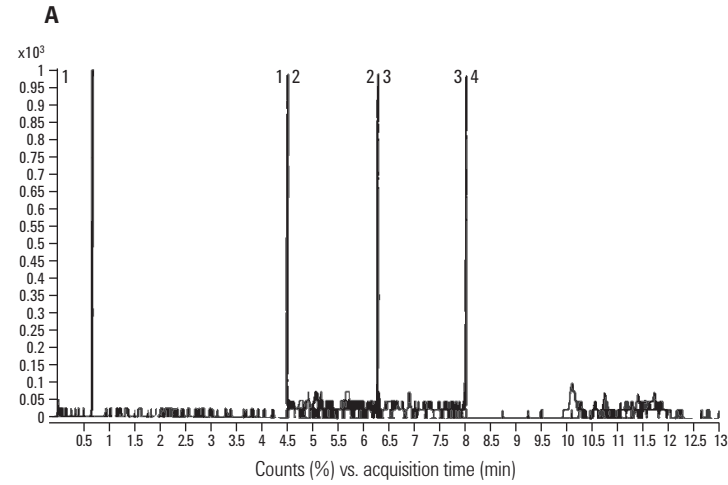

### Chromatogram of 10 ng/g fortified apple extract.

1. Methamidophos
2. Acephate
3. Pymetrozine
4. Carbendazim
5. Imidacloprid
6. Thiabendazole
7. Dichlorvos
8. Propoxur
9. Thiophanate methyl
10. Carbaryl
11. Ethoprophos
12. Penconazole
13. Cyprodinil
14. Dichlofluanid
15. Kresoxim
16. Tolyfluanid

### Chromatogram of Apple Extract Blank

No interference was found in the blank

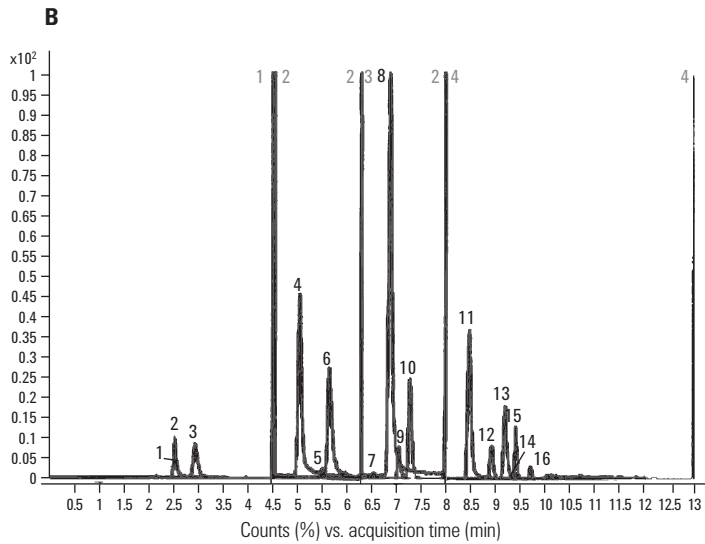

## References

---

1. Frankforter, G.B.; Cohen, L. *J. Am. Chem. Soc.* **1914**, *36*, 1103-1134.
2. Wang, B.; Ezeji, T.; Feng, H.; Blaschek, H. *Chemical Engineering Journal* **2008**, *63*, 2595-2600.
3. Leggett, D.C.; Jenkins, T.F.; Miyares, P.H. *Anal. Chem.* **1990**, *62*, 1355-1356.
4. *Method 8330A Nitroaromatics and Nitramines by High Performance Liquid Chromatography*, Rev. 1, U.S. Environmental Protection Agency, **January 1998**.
5. Luke, A.; Doose, G.M. *Bull. Environ. Contam.* **1983**, *30*, 110.
6. Mills, P.A.; Onley, J.H.; Gaither, R. A. *J. Assoc. Off. Anal. Chem.* **1963**, *46*, 186.
7. Schenck, F.J.; Wong, J.W.; J.L. Tadeo (Ed.) *Analysis of Pesticides in Food and Environmental Samples*, CRC Press, Boca Raton, FL, **2008**, 154.
8. Anastassiades, M.; Lehotay, S.J.; Stainbahr, D.; Schenk, F. *J. AOAC Int.* **2003**, *86*, 412-431.
9. Majors, R.E. *LCGC No. America* **2007**, *25 (5)*, 436-446.
10. Lehotay, S.J.; Mastovska, K.; Lightfield, A.R. *J. AOAC Int.* **2005**, *88*, 630-638.
11. *AOAC Official 2007.01 Method: Pesticide Residues in Foods by Acetonitrile Extraction and Partitioning with Magnesium Sulfate*, **2007**.
12. *EN 15662, Foods of Plant Origin – Determination of Pesticide Residues Using GC/MS and/or LC-MS/MS Following Acetonitrile Extraction/Partitioning and Cleanup by Dispersive SPE – QuEChERS Method*, **2008**.
13. Lehotay, S.J.; Mastovska, K.; Lightfield, A.R. *Use of buffering to improve results of problematic pesticides in a fast and easy method for residue analysis of fruits and vegetables*, *J. AOAC Int.* **2005**, *88*, 615-629.
14. <http://www.quechers.com/> (follow link to QuEChERS – A Mini-Multiresidue Method for the Analysis of Pesticide Residues in Low-Fat Products)
15. Stevens, J.; Bertin, L.; Rothermich, M. *Increasing Efficiency and Pesticide Recovery from the QuEChERS Approach for Fruit and Vegetable Products Using Ceramic Homogenizers*, European Pesticides Residue Workshop, Strasbourg, Poster 24, **June 20-24, 2010**.
16. Zhao, L.; Stevens, J. *Optimizing Recoveries of Planar Pesticides in Spinach Using Toluene and Agilent Bond Elut QuEChERS AOAC Kits with Graphitized Carbon*, Agilent Technologies Application Note #5990-4247EN, **2012**.
17. Anastassiades, M.; Masrovska, K.; Lehotay, S.J. *J. Chromatogr. A* **2003**, *1015 (1-2)*, 163-184.
18. Masrovska, K.; Lehotay, S.J.; Anastassiades, M. *Anal. Chem.* **2005**, *77 (24)*, 8129-8137.
19. Zhao, L.; Schulz, D.; Stevens, J. *Analysis of Pesticide Residues in Apples Using Agilent SampliQ QuEChERS Kit by LC-MS/MS Detection*, Application Note #5990-3937EN, Agilent Technologies, Wilmington, DE, **2009**.

# Solid Phase Extraction (SPE)

Solid phase extraction is one of the more widely used sample preparation techniques for liquid samples or solid samples that have been put into a liquid form by dissolution or extraction. SPE can also be used for certain gaseous sample by trapping them on a sorbent or by in situ derivatization using reactive chemicals.

## SPE vs. LLE

Solid phase extraction is an important technique used in sample pre-treatment for chromatographic analysis. SPE can be used in similar fashion as liquid-liquid extraction (LLE). Whereas LLE is a one-stage separation process, SPE is a chromatographic procedure that resembles HPLC and has a number of potential advantages compared to LLE:

- More complete extraction of the analyte
- More efficient separation of interferences from analytes
- Increased separation selectivity
- Reduced organic solvent consumption
- Easier collection of the total analyte fraction
- A trace-enrichment process offering inherent concentration potential
- More convenient manual procedures
- Removal of particulates
- More easily automated

Because SPE is often a more efficient isolation process than LLE, it is easier to obtain a higher recovery of the analyte. LLE procedures that may require several successive extractions to recover 99+% of the analyte often can be replaced by one-step SPE methods. With SPE, it is also possible to provide a more complete removal of interferences from the analyte fraction. Reversed-phase SPE techniques (commonly called non-polar SPE or RP-SPE) are the most popular as only smaller amounts of organic solvent are required, maintaining a high concentration of analyte. Because there is no need for phase separation (as in LLE), the total analyte fraction is easily collected in SPE, eliminating errors associated with variable or inaccurately measured extract volumes. In SPE, there is no chance of emulsion formation. Finally, larger particulates are trapped by the SPE cartridge or other device (see Chapter 5) and do not pass through into the analyte fraction. Thus, SPE has a dual function of cleanup and particulate removal and may eliminate the need for filtration prior to injection. In most cases, non-polar SPE offers concentration as an added benefit.

However, there are some disadvantages of SPE vs. LLE that include:

- Mixed mechanisms in SPE can occur
- Irreversible adsorption of some analytes on SPE cartridges
- More complex method development is required (3 or more steps involved)

The solvents used in LLE are usually pure and well defined, so that LLE separations are quite reproducible. On occasion, SPE phases can result in multiple mechanisms (e.g. reversed-phase and ion exchange) and may confuse the operator. The surface area of an LLE device (e.g., separatory funnel) is quite small compared to an SPE cartridge, and especially its packing. For this and other reasons, irreversible binding of analyte (with lower recoveries) is less likely with LLE vs. SPE. There are four steps in a typical non-polar SPE: conditioning, loading, washing, and elution – each of which requires some degree of optimization while solvent selection in LLE may be more straightforward.

## SPE vs. HPLC

In its simplest form, SPE employs a small plastic disposable column or cartridge, often the barrel of a medical syringe packed with 0.1-10.0 g sorbent. The sorbent is commonly a reversed-phase material, e.g., C18-silica, and reversed-phase SPE (RP-SPE) and resembles both LLE and reversed-phase HPLC in its separation characteristics. More selective SPE phases (e.g. ion exchange, affinity) can sometimes be a better choice than RP-SPE, which mainly distinguishes analytes and matrix in terms of their relative hydrophobicity.

For simplicity, in the following explanations, we will assume that RP-SPE is being used, unless noted otherwise. Although silica gel-based bonded phase packings are the most popular, polymeric sorbents have become available in recent years and have been gaining in popularity. Compared to silica-based SPE packings, polymeric packings have the advantage of higher surface area (thus higher capacity), chemical balance of hydrophilic-hydrophobic properties (better wettability and can dry out somewhat after the conditioning step without affecting recovery and reproducibility), absence of silanols (less chance of irreversible adsorption of highly basic compounds), and wide pH range (more flexibility in adjusting chemistries).

In its most popular configuration, the SPE packing is held in the syringe barrel by frits, just like an HPLC column. The particle size (40  $\mu\text{m}$  average) is typically much larger than that in HPLC (1.5-10  $\mu\text{m}$ ). Because of shorter bed lengths, larger particles, and less well packed beds, SPE cartridges are much less efficient ( $N < 100$ ) than an HPLC column. For cost reasons, irregularly-shaped packings (rather than spherical particles) are usually used in SPE. Recently, spherical silicas for SPE have come onto the marketplace but have not impacted the sale of the most popular products. Polymeric sorbents are generally spherical but usually more expensive than silica-based packings. Some of the SPE disks do, however, use the more expensive spherical SPE packings with particle diameters in the 7  $\mu\text{m}$  range.

Overall, the principles of separation, phase selection, and method development for SPE are similar to those for HPLC. One major difference between SPE and HPLC is that the SPE cartridge is generally used once and discarded, since potential interferences may remain on the cartridge. Of course, HPLC columns are used over and over again.

# Uses of SPE

SPE is used for six main purposes in sample preparation:

- Removal of interferences
- Concentration or trace enrichment of the analyte
- Desalting
- Phase exchange
- In situ derivatization
- Sample storage and transport

## Interference removal

Interferences from matrix or undesired compounds in the sample that overlap analyte bands in the HPLC or GC separation complicate method development and can adversely affect assay results. In some cases, especially for complex samples (e.g. natural products, food, protein digests), a large number of interferences in the original sample may make it almost impossible to separate these from one or more analyte bands with only one HPLC or GC separation. SPE can be used to reduce or eliminate those interferences. Some samples contain components, e.g., hydrophobic substances (e.g. fats, oils, greases), proteins, polymeric materials, particulates that can either plug or deactivate the HPLC column. These detrimental compounds can often be removed by RP-SPE. In GC, high boilers can lodge at the head of the column and slowly bleed off giving extraneous peaks and baseline drift. SPE can help remove these interferences prior to injection as well.

## Trace enrichment/analyte concentration

SPE can often be used to increase the concentration of a trace component. If an SPE cartridge can be selected so that  $k \gg 1$  for the analyte – a relatively large volume of sample – can be applied before the analyte saturates (overloads) the stationary phase and begins to elute from the cartridge. The net result is a considerable increase in the concentration of analyte when eluted with a strong solvent ( $k < 1$ ), which implies an increase in detection sensitivity (called trace enrichment). An example of trace enrichment is the use of SPE to concentrate sub-parts per billion concentrations of polynuclear aromatic hydrocarbons<sup>1</sup> or pesticides<sup>2</sup> from environmental water samples using an RP-SPE cartridge. A strong solvent (e.g., ACN or MeOH) elutes these analytes from the cartridge in a small concentrated volume, which also saves on evaporation time. If taken to dryness, the sample residue can then be redissolved (reconstituted) in a solvent compatible with the subsequent HPLC or GC separation. Alternatively, a miscible weak solvent can be added to the SPE eluant to dilute the stronger solvent and perhaps allow direct injection of the resulting sample into an HPLC column.

## Desalting

RP-SPE is often used to desalt biological and other high-salt samples, especially prior to ion exchange HPLC. Conditions of pH and %-organic are selected to retain the analyte initially, which allows the inorganic salts to be washed from the cartridge with water. The analyte can then be eluted (salt-free) with organic solvent<sup>3</sup>.

## Phase exchange

Although used less frequently than the previous uses, phase exchange can be performed by isolating the analyte of interest on the SPE cartridge, then by flowing air or dry nitrogen through the cartridge to remove the initial liquid. Next, a second non-compatible solvent can be used to elute the analyte into a collection device for further sample preparation or injection into a chromatograph.

## In situ derivatization

In one of the procedures of in situ derivatization, an active derivatizing reagent is sorbed onto an SPE cartridge and a sample containing an active analyte is passed through the cartridge. Depending on the reaction kinetics, the analyte can be simultaneously derivatized and concentrated. A strong solvent can then be used to elute the derivatized compound which can then be handled chromatographically. One example of such a procedure in practice is the in situ derivatization of carbonyl-containing compounds with 2,4-dinitrophenylhydrazine<sup>4</sup>. Another approach to in situ derivatization involves the in-solution derivatization in the presence of a SPE sorbent that isolates the derivatized analyte in solution. Subsequently, the derivatized compound is eluted for analysis. An example of this approach involved the thermal hydrolysis and direct methylation of bacterial fatty acids with tetramethylammonium hydroxide from a sample of bacterial lipids. The derivatized fatty acid methyl esters were then subjected to GC-ion mobility mass spectrometry for analysis<sup>5</sup>. Another example of this approach is the in situ derivatization of acidic pesticides that were reacted with butylchloroformate in an aqueous environment and then extracted using on-line SPME cleanup using a PDMS fiber with subsequent thermal desorption into a GC/MS<sup>6</sup>.

## Sample storage and transport

Sample storage and/or transport is an interesting application of SPE cartridges. Oftentimes, analytes adsorbed to a solid support are stabilized relative to their stability in solution. This observation allows samples to be stored on a cartridge sorbent allowing for storage and for transport (through the mail, for example). Before using this approach, individual set of analytes should be tested in terms of longterm stability when sorbed to a solid support.



# SPE Devices and Formats

There are several designs that are used for SPE:

- Cartridge (**Figure 9.1**)
- Disk (**Figure 9.2**)
- Pipette tip (**Figure 9.3**)
- 96-well plate (**Figure 9.4**)
- Coated fiber (solid phase microextraction, SPME, **Figure 9.5**)  
or coated stir bar (stir bar sorbent extraction, SBSE, **Figure 9.6**)

Figure 9.1

## Typical Syringe Barrel Cartridge Design

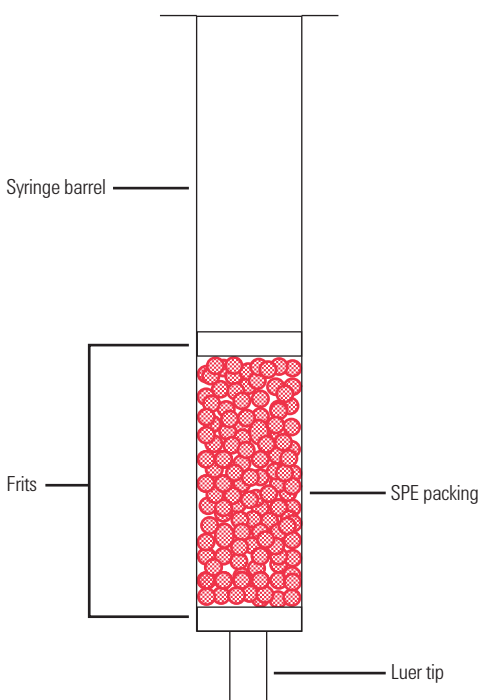

## SPE cartridges

The most popular configuration for an SPE device is the cartridge. A typical SPE disposable cartridge (syringe barrel format) is depicted in **Figure 9.1**. The syringe barrel is usually medical-grade polypropylene, chosen for its purity. If trace levels of impurities such as plasticizers, stabilizers, or mold release agents are present in the plastic used for cartridges, they may be extracted during the SPE process and contaminate the sample, perhaps giving improper results or causing ion suppression in mass spectrometry. The outlet of the syringe barrel normally has a Luer tip so that a needle can be affixed to direct effluent directly into a small container or vial.

The frits maintaining the particle bed in the cartridge are of PTFE, polyethylene, stainless steel, or titanium (rarely) construction with porosity of 10-20  $\mu\text{m}$  that offers little flow resistance. SPE cartridges may vary in design to fit an automated instrument or robotics system. More expensive but more inert cartridges of glass or virgin PTFE are available for ultratrace analyses (sub-parts per billion) when the standard syringe barrel plastics may produce unacceptable concentrations of extractable interferences or adsorption on the plastic walls.

With the exception of special cartridges referred to above, in general, SPE cartridges packed with bonded silica or sorbent packings are relatively inexpensive. They are generally used a single time and discarded because of the potential of sample cross-contamination.

To accommodate a wide range of SPE applications, standard cartridges are also available with reservoir volumes (the volume above the packing in the cartridge) of 0.5-10 mL with packing weights of 35 mg-2 g. For very large samples, "mega" cartridges have up to 75 g of packing and a 150 mL reservoir. These cartridges can also be considered for use in flash chromatography applications (see Chapter 12), although flash chromatography and "true" SPE differ in theory as well as in practice. Cartridges with a larger amount of packing should be used for dirty samples that can overload a low capacity cartridge. However, cartridges containing 100 mg of packing or less are preferred for relatively clean liquid samples where cartridge capacity is not an issue, or for trace analysis and small sample volumes. Due to the higher surface areas of polymeric SPE packings and potentially greater retentive capacity per unit area, packed bed masses are typically in the 5-60 mg range, which leads to smaller volumes of sample and solvent. In most cases, it is desirable to collect the analyte in the smallest possible volume, which means that the SPE cartridge generally should also be as small as possible. Smaller volumes also take less time to evaporate the elution solvent when reconstituting to a solvent that is more compatible with the analytical method.

## SPE disks

Another popular configuration is the SPE disk (**Figure 9.2**). SPE disks combine the advantages of membranes (see Chapter 18) and solid phase extraction. In their appearance, the disks closely resemble membrane filters: they are flat, usually one mm or less in thickness, with diameters ranging from 4-96 mm. The SPE packing in these disks generally comprises 60-90% of the total membrane weight. Some disks are sold individually and must be installed in a reusable filter holder. However, the most popular disks are sold pre-loaded in disposable holders or cartridges with Luer fittings for easy connection to syringes. The physical construction of the SPE disks differs from membrane filters (see Chapter 18). SPE disks consist of:

- Flexible- or expanded-PTFE networks that are filled with silica-based or resin packings
- Rigid fiberglass disks with embedded packing material
- Packing-impregnated polyvinylchloride
- Derivatized membranes

Figure 9.2

### Typical SPE Disk Configuration

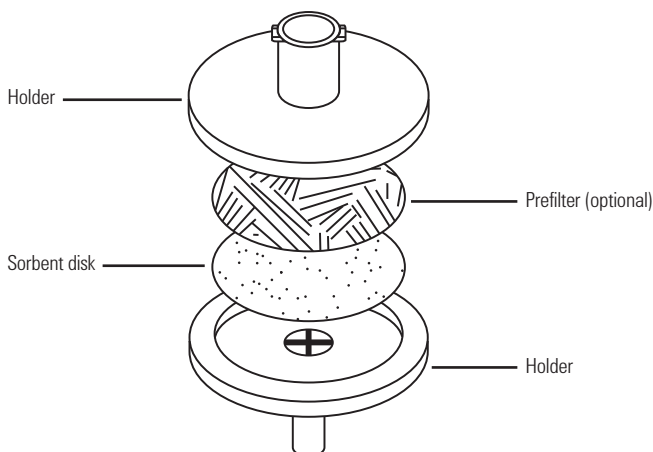

SPE disks and cartridges differ mainly in their length/diameter ratio ( $L/d$ ): disks have  $L/d < 1$  and cartridges have  $L/d > 1$ . Compared to SPE cartridges, this characteristic of the disk enables higher flow rates and faster extraction. For example, one liter of relatively clean water can pass through a 45 mm diameter disk in approximately 15-20 min, but may require 2 h when using a 15 mm x 8 mm cartridge bed. "Dirty" water, or water containing particulates, such as wastewater, can plug the porous disks, just as in the case of cartridges. In either case, a prefilter should be used prior to the SPE treatment if the samples contain substantial particulates. Some disk products come with a prefilter already built-in. Because the packing material is embedded in the disk matrix, channeling, which can cause uneven flow characteristics with subsequent lower analytes recovery with poorly-packed cartridges, is absent. However, due to the thinness of the disk (typically 0.5-2 mm), compounds with low  $k'$  values tend to have lower breakthrough volumes than for SPE cartridges.

SPE disks have been found to be useful for environmental applications such as the analysis of trace organics in surface water, which often require a large sample volume to obtain the necessary sensitivity. The United States Environmental Protection Agency has approved SPE disk technology (Method 3535A) as an alternative for LLE<sup>7</sup> in the preparation of water samples for HPLC analysis. A major advantage of SPE vs. conventional LLE is the reduced consumption of organic solvents. SPE disks and cartridges require only a few milliliters of solvent per assay, compared to hundreds of milliliters for comparable multi-step LLE separations.

Low-bed-mass, rigid fiberglass disks with 1.5-30 mg of embedded packing material are useful for pretreating small clinical samples (e.g. plasma or serum). Here, the reduced sorbent mass and small cross-sectional area reduces solvent consumption. An advantage of this type of disk is cleaner extracts due to reduced elution solvent volume, less interference from weakly retained compounds, and an absence of frits that are a possible source of contamination. Examples of such disks are the high capacity SPEC phases (Agilent Technologies) which are available in cartridges or 96-well plates (see **Figure 9.4**). Reversed-phase (C2, C8, C18, C18AR, and Phenyl), normal phase (NH<sub>2</sub>, CN, Si), ion exchange (SAX, SCX) and mixed-mode (non-polar and SCX) are available in the SPEC disk format.

Although packing-impregnated polyvinylchloride (PVC) and derivatized membranes available in disk or cartridge format are used in biological sample isolations, they are used very little in SPE applications and will not be further discussed here.

## SPE pipette tip

The move towards miniaturization in analytical chemistry has prompted the development of new formats for SPE. The micropipette tip (MPT) format (**Figure 9.3**) permits the handling of sub-microliter amounts of sample such as biological fluids. Solid phase extraction (SPE) has been performed with various phases packed, embedded, or coated on the internal walls of the pipette. The open flow architecture allows liquid samples to be moved and transferred without undo pressure drop or plugging. Many popular SPE techniques have been demonstrated including reversed-phase-, ion exchange-, hydrophobic interaction-, hydrophilic interaction-, immobilized metal affinity-, and affinity-chromatography. Micropipette tip-based SPE (MPT-SPE) has mainly been used for purification, concentration and selective isolation (affinity, metal chelate) of proteins and peptides. A unique pipette tip design is based on monolithic sorbent technology. OMIX tips (Agilent Technologies) are of a small volume (10  $\mu\text{L}$  and 100  $\mu\text{L}$ ) and small mass (0.25-2 mg) primarily designed for proteomics applications. Reversed-phase (C4, C18) and a strong cation exchange phase (SCX) are available. MPT formats are available for specific automated robots such as the Hamilton Microlab Star Series (300  $\mu\text{L}$  tip volume) and the Tomtec Quadra (450  $\mu\text{L}$  tip volume).

**Figure 9.3**  
**Solid Phase Extraction Pipette Tip**

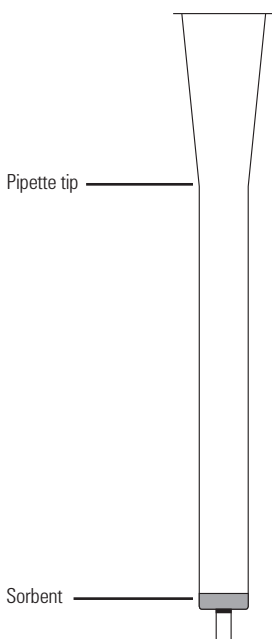

In recent years, interfacing the small volume MPT-SPE devices to MS or LC/MS has been a popular isolation/cleanup and identification technique in proteomics. Two techniques for the mass spectrometric (MS) analysis of proteins include electrospray ionization (ESI) and matrix-assisted laser desorption/ionization (MALDI)<sup>8, 9, 10</sup>. ESI is used to ionize biomolecules in solution, while MALDI is used to sublimate and ionize a sample in a crystalline, dry matrix via a laser pulse. MPT-SPE is now an essential tool for MALDI and for other advanced MS techniques<sup>11, 12</sup>. One of the main advantages of micropipette tips is that they can be used with micropipettors or in liquid handling automation. This has resulted in the routine use of MPT-SPE in bioanalytical labs and it is easily adapted for use in high-throughput screening applications with commercially available x-y-z liquid handling systems.

## SPE 96-well plates

The 96-well plate configuration (**Figure 9.4**) consists of an 8x12 array of small, flow-through SPE wells with the packing contained by top and bottom frits. These plates are quite amenable to automation and most modern liquid handling equipment will accommodate the various steps required for the SPE operation. There are three types of 96-well SPE plates, mostly based on a standard external dimension: 1) fixed round well, 2) fixed square well, and 3) removable square well. The round well configuration comes in fixed volumes (usually 0.5-1.0 mL) with various amounts of SPE packing (silica: 25-100 mg; polymer: 2-25 mg). The packing in each well is generally the same material. The square well configuration can accommodate larger volumes of sample (up to 2.0 mL) and usually contains fixed packing material in each well. The removable square well plates, such as the Agilent Technologies VersaPlate, are suited to those who wish to assemble their own 96-well phase configurations. Using a universal base plate, small cartridges with the same or different stationary phases and with different masses of packing can be placed in any order. This type of plate allows one to match the number of cartridges to the number of samples, so an entire plate isn't sacrificed for fewer than 96 samples. The unused "holes" can be plugged with available stoppers so that a vacuum can be applied. Such plates are quite useful for method development when one is attempting to find the optimum stationary phase and/or sorbent mass.

96-well SPE plates for method development are also available. These fixed wells are filled with various sorbents or disks with different stationary phases. The user can set up various loading, washing, and elution conditions with a series of phases to come up with the best combinations to isolate analytes from matrix compounds. For example, Agilent's SPEC method development plates contain the following silica-based stationary phases: C2, C8, C18, C18AR (acid resistant), cyano, phenyl, MP1 (mixed mode C8 + SCX), and MP3 (similar to MP1 but with additional polar retention).

Figure 9.4

### 96-Well SPE Plate



## Solid phase microextraction (SPME)

Coated fibers are used for SPME. In this design (**Figure 9.5**), a fine, solid fused silica fiber is coated with a polymeric stationary phase, such as a polydimethylsiloxane (PDMS) or a polyacrylate<sup>13</sup>. The fiber is dipped into the solution to be analyzed, and analytes diffuse to and partition into the coating as a function of their distribution coefficients. Once equilibrium is achieved, which may take tens of minutes to occur, the fiber is removed from solution and placed into the injection port of a GC inlet where analytes are displaced by thermal desorption. The SPME-GC technique has proven to be very versatile and has been used for many applications in environmental and food areas for volatile analytes. For non-volatiles, an HPLC version where analytes are desorbed from the fibers by solvent desorption (elution) is available, but this method has proven to be less useful than the GC version. For a more complete coverage of SPME, refer to Chapter 10 of this book or to a general textbook by the inventor<sup>14</sup>.

Figure 9.5

### SPME Syringe Assembly

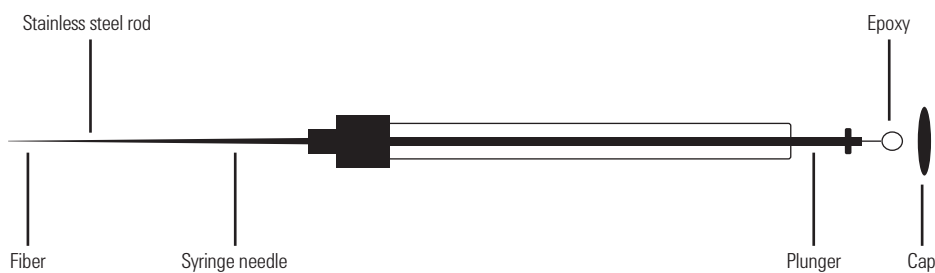

## Stir bar sorbent extraction (SBSE)

The concept of a coated stirring bar<sup>15,16</sup> is similar to that of a coated SPME fiber but the greatly increased surface area allows for greater mass sensitivity (see **Figure 9.6**). The stir bar, with a polymeric sorptive coating, is placed into an aqueous liquid and the solution stirred while analyte/matrix partitioning takes place. After equilibrium, again requiring tens of minutes, the stir bar is removed, dried to remove traces of water, and then transferred to a thermal desorption device where the analytes are displaced into the GC column. For HPLC, off-line solvent desorption is the preferred approach for analyte release from the stir bar.

Figure 9.6

### Coated Stir Bar

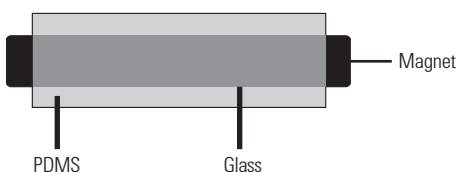

Both coated fiber and stir bar devices are more popular in gas chromatography where thermal desorption is more efficient in volatilizing sorbed analytes into the gas phase than solvent desorption in the liquid phase. In both devices, very volatile analytes can be lost due to evaporation during the transfer process.

For the purposes of brevity, the SPE separation device described in the remainder of the SPE section will be referred to as a typical "SPE cartridge". In most cases, the other SPE devices will perform in a similar manner.



# SPE Apparatus

The equipment needed to perform the SPE experiment can be very simple (**Figure 9.7**). Gravity can be used as the driving force, but flow-through the cartridge with "real" samples is sometimes extremely slow and impractical for general use. Thus, the most useful basic system (**Figure 9.7A**) employs a syringe to manually push solvent or sample through the cartridge. This method may be difficult if the sample is viscous or contains particulates. In this case, a vacuum flask that can handle one cartridge at a time can be used instead (**Figure 9.7B**). However, when several samples must be processed simultaneously, a vacuum manifold or positive pressure system for processing multiple cartridges at a time is recommended (**Figure 9.7C**). Systems are available that can accommodate up to 24 SPE devices. These manifold systems are constructed of chemically-resistant, vacuum-safe, see-through glass. The see-through glass allows monitoring of the entire sample collection process. A removable, height-adjustable, solvent-resistant rack is located inside the vacuum manifold to hold various sizes of test tubes or vials for eluant collection or waste containers for conditioning, loading, and wash solvents. Delivery needles connecting the cartridges to the collection tubes/vials are constructed of inert, polypropylene, PTFE, or stainless steel, and are aligned so that solvent is directed to the appropriate collection device. In this manner, cross-contamination during the analyte elution step can be avoided.

Figure 9.7  
Apparatus of SPE

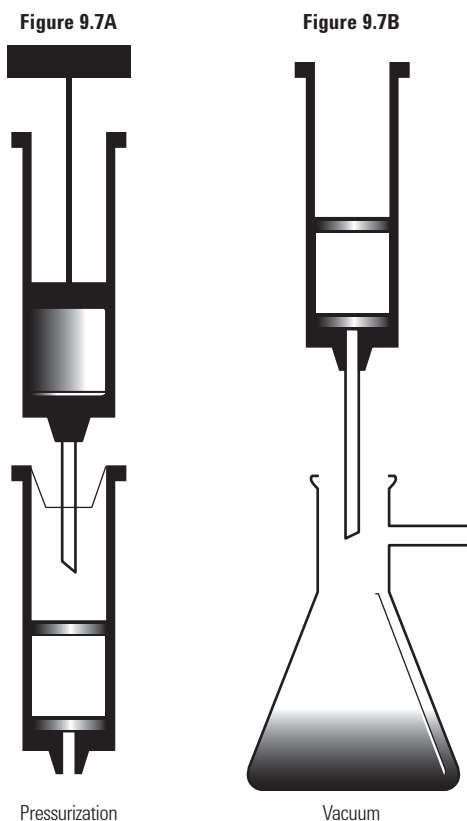

In some units, a vacuum bleed valve, a vacuum control valve, and a vacuum gauge are incorporated to allow better control of the solvent flow. In the more sophisticated units, individual controls for each cartridge are provided to ensure that there is an even flow distribution among all of the cartridges. Finally, a sidearm vacuum flask is placed between the vacuum manifold and the vacuum source to collect overflow rinse and wash solvent and prevent liquids from contaminating the vacuum pump. There are also positive pressure manifold and constant flow systems on the market that provide individual flow control for each of the cartridges. As the degree of sophistication goes up, so does the price of the apparatus. Centrifugation has been less commonly used to drive liquid through the cartridge (**Figure 9.7D**).

If 96-well SPE plates are used, a special vacuum manifold is required. **Figure 9.7E** shows such a manifold system; in the bottom figure, an actual 96-well SPE plate is mounted on the manifold, and a 96-well collection plate is used to collect the final eluants. Special waste containers are also available for the loading and rinsing steps.

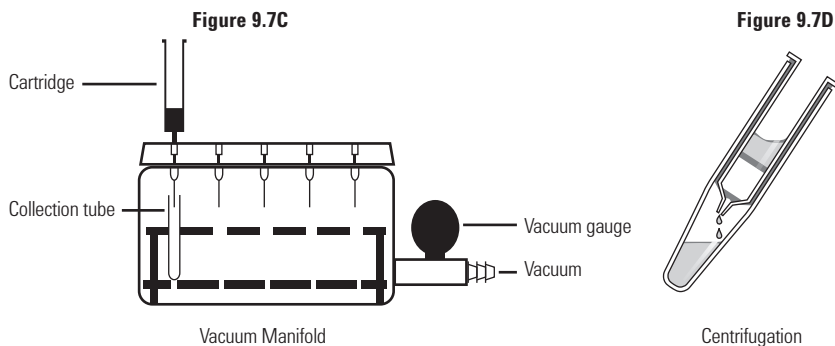

**Figure 9.7E**



CaptiVac Vacuum Manifold for 96-Well Plates



96-Well SPE Plate Mounted on CaptiVac Vacuum Manifold

Regardless of the method used to push sample solution through the SPE cartridge or other SPE device, the flow rate should not be too fast. Otherwise, there may be an insufficient amount of time for interaction of the sample with the stationary phase; the kinetics of mass transfer in SPE is the same as in HPLC. For typical SPE applications, it is recommended that a flow rate be 10 mL/min or less for a 6 mL cartridge and 50 mL/min for a 90 mm disk. Otherwise, sample losses may occur due to the slow sorption kinetics.

# SPE Automation

When the number of samples increases such that SPE sample preparation becomes the “bottleneck”, it becomes feasible to automate the entire process. There are three basic approaches to SPE automation:

1. Dedicated SPE equipment
2. Modified x-y-z liquid handling systems
3. Robotic workstations

The simplest and least expensive instrumentation is a dedicated SPE device that performs conditioning, loading, washing, and elution. Such systems may use standard syringe barrel cartridges, special cartridges that are designed to fit the apparatus, or SPE disks. Gilson’s ASPEC, Thermo Fisher Scientific’s AutoTrace 280, and Horizon Technologies’ SPE-DEX fall into this dedicated category.

Modified x-y-z liquid handling systems are mainly used to perform liquid handling functions such as dilution, mixing, and internal standard addition. Systems such as the Agilent Technologies Bravo, Agilent PAL sample injectors, Hamilton Microlab Star, Tomtec Quadra, and Gerstel Multipurpose Sampler (MPS) are very versatile in performing and assisting in various sample preparation functions. Such units can not only perform up to several sample preparation steps, but can also inject the final cleaned-up sample into the chromatograph. Solid phase extraction can be performed using SPE micropipette tips (for small volume samples), 96-well SPE plates and, in some cases, SPE cartridges and disks. This modified liquid handling approach seems to be in favor these days.

Although a full laboratory robotic system can be interfaced to devices which perform all of the steps of the SPE experiment, it may be more time and cost effective to interface the robot to a dedicated SPE workstation. The robot serves to move sample containers to and from the SPE workstation, as well as to and from other sample preparation devices (e.g. balances, mixers, dilutors, autosamplers, etc.) located on the laboratory bench. There are several system integration companies who can assemble a full robotic system which will fulfill this more fully automated laboratory system. At one time, this approach was more widely used, but full robotic laboratories are currently less frequent.

# Practice of SPE

An overview of SPE separation: In its most popular form of experimentation, the application of SPE generally involves four steps (Figure 9.8):

1. Conditioning the packing (Figure 9.8.1)
2. Sample application (loading) (Figure 9.8.2)
3. Washing the packing (removal of interferences) (Figure 9.8.3)
4. Elution and recovery of the analyte (Figure 9.8.4)

Each of these steps must be optimized during the process of method development. First, an overview of this 4-step process will be provided, and then under the section *Practical Guidelines for Method Development*, more details will be provided.

Figure 9.8

## Steps in SPE Process

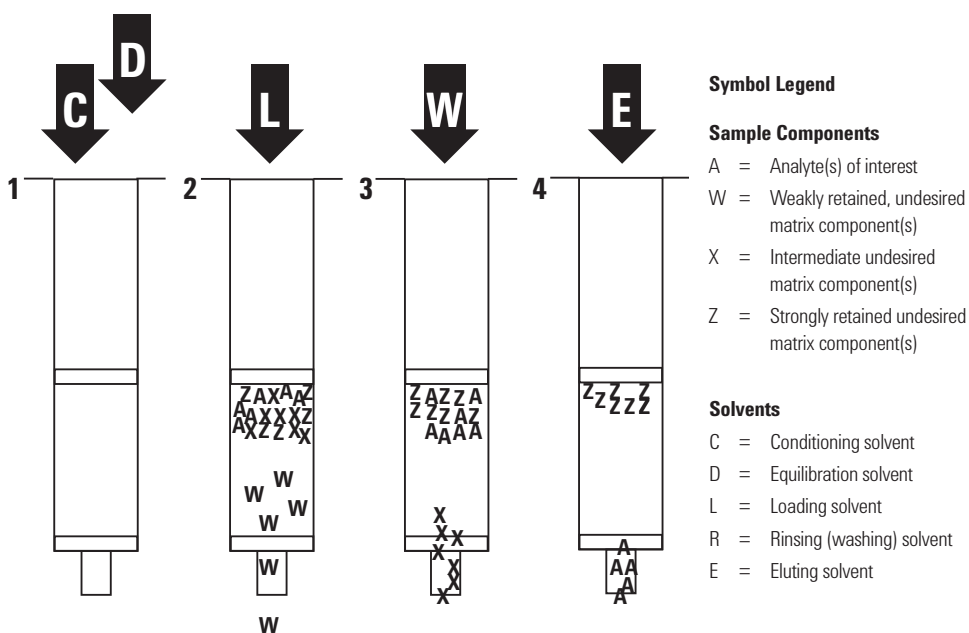

We sometimes call this SPE operational mode the “bind-elute” mode. Since the SPE conditions are selected to bind the analyte and either allow the matrix and interferences to be less bound (passing through the cartridge unretained) or more bound (remaining on the cartridge for the rest of the SPE experiment). Then, a suitable solvent system is selected to elute the analyte, but not the more strongly retained interferences/matrix compounds in the smallest possible volume, ideally in a solvent compatible with the next step in the analysis. In this initial explanation, it is assumed that RP-SPE is used and the analyte is to be retained initially. In Chapter 10, other SPE modes such as ion exchange and complexation will be addressed.

## Step 1 – Conditioning

In this step (**Figure 9.8.1**), performed prior to addition of sample, the packing is “conditioned” by the passage of a few bed-volumes of solvent “C”, typically methanol (MeOH) or acetonitrile (ACN), through the cartridge. The role of the conditioning step is two-fold: (a) it removes any impurities that may have randomly collected while the cartridge was exposed to the laboratory environment or present in the cartridge supplied by the manufacturer, and (b) it allows the sorbent to be solvated. Solvation is important since reversed-phase silica-based packings (especially C8, C18, or phenyl) that have been allowed to dry out often exhibit a considerable decrease in sample retention of hydrophobic analytes. In addition, varying states of phase dryness lead to non-reproducible analyte recoveries. In this respect, polymeric packings, such as Bond Elut Plexa (Agilent Technologies) with a balance of hydrophobic-hydrophilic surface character, can dry out slightly and still maintain their performance. Plexa is a spherical SPE sorbent with monodisperse particles allowing very reproducible flow and a hydroxylated surface that displays less binding of matrix interferences.

Following conditioning, it is desirable to flush excess conditioning solvent with an equilibration solvent “D”. In RP-SPE, this is usually water or aqueous buffer, thus equilibrating the SPE device before sample loading. For very low volume SPE devices such as SPECK disk cartridges, however, where the void volume is far smaller than the sample size, this equilibration step is less important and may be eliminated.

## Step 2 – Sample Loading

This step (**Figure 9.8.2**) in the SPE experiment involves sample application (loading) where the sample, dissolved in a weak solvent “L”, is added to the cartridge. This weak solvent allows strong retention of the analyte. For RP-SPE operation, a weak solvent is water or buffer, with up to 10% of added organic. For ion exchange, a similar solvent is acceptable, but the ionic strength of the sample solution should be as low as possible. See **Table 9.1** for further information on loading solvents.

The sample for SPE can be applied with a pipette or syringe (manually or automatically with an autosampler or liquid handling robot), or pumped into the cartridge. The latter method is more convenient for large sample volumes (> 50 mL) such as when isolating trace organics from environmental water samples. The sample and cartridge sizes must be matched so as not to overload the capacity of the cartridge. Remember, the capacity of the cartridge must be sufficient to handle the total mass of sample (e.g., analytes, matrix, and interferences) that may all be retained during the loading step. The sample solution should be passed through the cartridge without allowing it to dry out. In most SPE setups, the flow rate is not precisely controlled as in HPLC, but it can be adjusted by varying the vacuum, the rate at which the contents from a syringe or from a pump is delivered. Flow rates of 2-4 mL/min are usually acceptable. Because of their larger cross-sectional area, disks can handle higher flow rates, but one should conduct a study on flow rate versus recovery for the analyte(s) of interest.

Table 9.1

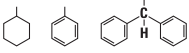
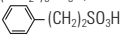
Typical SPE Phases and Conditions					
Mechanism of Separation	Typical Phases	Structure(s)	Analyte Type	Loading Solvent	Eluting Solvent
Normal Phase (Adsorption)	Silica, Alumina, Florisil	-SiOH, Al <sub>2</sub> O <sub>3</sub> , Mg <sub>2</sub> SiO <sub>3</sub>	Slightly to moderately polar	Small $\epsilon^0$ , e.g. hexane, CHCl <sub>3</sub> /hexane	Large $\epsilon^0$ , e.g. methanol, ethanol
Normal Phase (Polar Bonded Phase)	Cyano, Amino, Diol	-CN, -NH <sub>2</sub> , -CH(OH)-CH(OH)-	Moderately to strongly polar	Small $\epsilon^0$ , e.g. hexane,	Large $\epsilon^0$ , e.g. methanol, ethanol
Reversed-Phase (Non-polar Bonded Phase – strongly hydrophobic)	Octadecylsiloxane, Octylsiloxane, PS-DVB, DVB (Polymeric)	(-CH <sub>2</sub> ) <sub>17</sub> CH <sub>3</sub> , (-CH <sub>2</sub> ) <sub>7</sub> CH <sub>3</sub> PS-DVB, DVB	Hydrophobic (strongly non-polar)	High P', e.g. H <sub>2</sub> O, MeOH/ H <sub>2</sub> O, ACN/H <sub>2</sub> O	Intermediate P', e.g. MeOH, ACN
Reversed-Phase (Non-polar Bonded Phase – intermediate hydrophobicity)	Cyclohexyl, Phenyl, Diphenyl		Moderately non-polar	High P', e.g. H <sub>2</sub> O, MeOH/ H <sub>2</sub> O, ACN/H <sub>2</sub> O	Intermediate P', e.g. MeOH, ACN
Reversed-Phase (Non-polar Bonded Phase – low hydrophobicity)	Butyl, Ethyl, Methyl	(-CH <sub>2</sub> ) <sub>3</sub> CH <sub>3</sub> , -C <sub>2</sub> H <sub>5</sub> , -CH <sub>3</sub>	Slightly polar to moderately non-polar	High P', e.g. H <sub>2</sub> O	Intermediate P', e.g. MeOH, ACN
Polymeric Reversed-Phase (Hydrophobic – hydrophilic balanced)	Polyamide, poly [n-vinylpyrrolidone-divinylbenzene(DVB)], methacrylate-DVB	Various polymers	Acidic, basic, neutral	Water or buffer	Intermediate P', e.g. MeOH, ACN
Anion Exchange (Weak)	Amino, 1 <sup>o</sup> , 2 <sup>o</sup> -amino	(-CH <sub>2</sub> ) <sub>3</sub> NH <sub>2</sub> , (-CH <sub>2</sub> ) <sub>3</sub> <sup>-</sup> NHCH <sub>2</sub> CH <sub>2</sub> NH <sub>2</sub>	Ionic (ionizable), acidic	Water or buffer (pH = pK <sub>a</sub> + 2)	A. Buffer (pH = pK <sub>a</sub> - 2) B. pH value where sorbent or analyte is neutral C. Buffer with high ionic strength
Anion Exchange (Strong)	Quaternary amine	(-CH <sub>2</sub> ) <sub>3</sub> N <sup>+</sup> (CH <sub>3</sub> ) <sub>3</sub>	Ionic (ionizable), acidic	Water or buffer (pH = pK <sub>a</sub> + 2)	A. Buffer (pH = pK <sub>a</sub> - 2) B. pH value where sorbent or analyte is neutral C. Buffer with high ionic strength
Cation Exchange (Weak)	Carboxylic acid	(-CH <sub>2</sub> ) <sub>3</sub> COOH	Ionic (ionizable), basic	Water or buffer (pH = pK <sub>a</sub> - 2)	A. Buffer (pH = pK <sub>a</sub> + 2) B. pH value where sorbent or analyte is neutral C. Buffer with high ionic strength
Cation Exchange (Strong)	Alkyl sulfonic acid, Aromatic sulfonic acid	(-CH <sub>2</sub> ) <sub>3</sub> SO <sub>3</sub> H, 	Ionic (ionizable), basic	Water or buffer (pH = pK <sub>a</sub> - 2)	A. Buffer (pH = pK <sub>a</sub> + 2) B. pH value where sorbent or analyte is neutral C. Buffer with high ionic strength

For ion exchange, 3 possible elution conditions exist:

A: Buffer 2 units above (acids) or below (bases) pK<sub>a</sub> of analyte;

B: pH where either analyte or sorbent (weak exchangers) is neutral;

C: High ionic strength. P' represents polarity (octanol-water partition coefficient),  $\epsilon^0$  is the solvent strength<sup>18,19</sup>.

### Step 3 – Washing (Rinsing)

This step (**Figure 9.8.3**) provides for the removal of interferences by washing (rinsing) the cartridge with a solvent “W” of intermediate strength. Ideally, the choice of wash-solvent strength and volume should be limited; too large a volume or too strong of a wash solvent may result in the partial elution of the analyte and thus lower overall recovery. Optimally, the wash step (step 3) is discontinued just before the analyte begins to leave the cartridge. In this way, interferences that are more weakly retained than the analyte are washed from the cartridge, but no loss of analyte occurs. Water or a buffer is often used for the wash solvent in RP-SPE, but this may not provide a maximum removal of interferences from the analyte fraction that is collected in step 4 (**Figure 9.8.4**). A small, controlled amount of organic solvent may be added to the wash solution to aid in the removal of more hydrophobic substances, but care must be taken that the analyte of interest is not removed at the same time. The breakthrough volume must be determined experimentally (**see Figure 9.11**). Because of the possible slight variability of the SPE separation from cartridge-to-cartridge, there must be some method robustness built in the optimum wash solvent strength used to remove interferences from the cartridge. Our ultimate goal is collecting 100 percent of the analyte in step 4 (**Figure 9.8.4**) without the presence of matrix or undesired interfering compounds; otherwise, poor and/or variable recoveries will result.

Note that for very clean samples such as drinking water, the wash step may be omitted without compromising the extraction performance (various U.S. EPA Methods omit the wash step and go straight to drying before elution). If the sample is complex and contains many unwanted matrix components, then the wash step is necessary and should be optimized.

### Step 4 – Elution

This step (**Figure 9.8.4D**) provides for elution and collection of the analyte fraction. If detection sensitivity is a major concern, then the goal should be the collection of the total mass of analyte(s) in as small a volume as possible. This can be achieved with an elution solvent “E” that is quite strong, so that  $k \ll 1$  for the analyte band during elution. Alternatively, the use of a weaker solvent “E” that still provides elution of the analyte (e.g.,  $k \approx 1$ ) will minimize the elution of more strongly retained interferences that should remain on the cartridge. This is an important consideration in HPLC when late-eluters are present in significant amounts, since these compounds may increase the required run time for the subsequent HPLC separation. Again, in GC, the degree of cleanup must be determined experimentally. If an intermediate strength elution solvent “E” is used with a resulting large volume of the analyte fraction, it is always possible to evaporate the eluent to dryness and reconstitute the residue in the HPLC mobile phase or in a GC-compatible solvent in order to reduce the final analyte fraction volume. Evaporation to dryness is often required in any event, since the elution solvent “E” for SPE may be too strong a sample solvent for the HPLC separation or may affect the stationary phase in the GC column, especially for coated phases. For this reason, choose solvent “E” that is relatively volatile; otherwise a long time will be required to evaporate a large volume or an inconvenient rotary evaporation under vacuum may be needed. Sometimes, using our knowledge of chemistry, we can use an additive that may make the analyte of interest less volatile, such as adding some HCl to an amine analyte to transform it into a salt.

For HPLC, it is desirable to collect the analyte fraction in an elution solvent that will be a weak mobile phase for the subsequent separation. In this case, larger volumes of the analyte fraction can be injected more conveniently and with greater detection sensitivity. There are two ways in which this goal can be achieved. First, if the analyte is an acid or base, the pH of the sample can be adjusted to suppress analyte ionization and maximize RP-SPE retention. Elution of the analyte in step 4 can then be effected by a change in pH so as to ionize the sample and reduce its retention. After the analyte fraction is collected, the pH of the fraction can be re-adjusted for optimum retention in the subsequent HPLC separation. A second approach is the use of a "weak" SPE column packing (cyano or short-chain alkyl), so that the elution solvent need not be so strong. In this case, a "strong" HPLC column (e.g., C18) would be used to assay the SPE fraction.

In GC, it is best to collect the eluted analyte in a volatile solvent that will be compatible with the GC stationary phase. Many GC capillary columns will not tolerate injections of large amounts of water, or polar organic solvent, or liquids containing acidic or basic solvents. If a strong non-volatile solvent must be used, then solvent exchange will be required either by evaporation or use of another SPE cartridge (see Uses of SPE).

Note that if a small volume of elution solvent is used or if the elution solvent is immiscible with the wash solvent, it is necessary or at least highly desirable to eliminate the wash solvent from the cartridge before elution. Elimination of the wash solvent is accomplished by simply passing air under vacuum (or pressurized air or inert gas) through the cartridge until it is dry. This process may take a few seconds for small volume SPE devices to several minutes for larger SPE tubes or disks.

## Matrix Adsorption SPE Mode

In an alternative approach, SPE can also be used to retain impurities and allow the analyte(s) of interest to pass through the cartridge unretained. This technique is sometimes called chemical filtration since it "filters out" strongly retained sample components. This mode has also been referred to as the matrix adsorption mode or interference removal mode of SPE. This option does not provide for any concentration of the analyte in its SPE collected fraction. It is also not possible to separate the analyte from more weakly retained interferences. Therefore, this SPE mode usually provides "dirtier" analyte fractions and further cleanup may be required prior to analysis (see reference 20 for other recommended cleanup procedures). The bind-elute procedure illustrated in **Figure 9.8** allows the separation of analyte from both weakly- and strongly-retained sample matrix components. For this reason, the matrix adsorption mode is used less often for sample pre-treatment and will not be described further.



## SPE Phases and Chemistries

Because SPE is really a low-efficiency adaptation of HPLC, many phases used in HPLC are also available in SPE versions. **Table 9.1** lists the more popular SPE phases and the analyte types retained by them. Bonded silicas are still the most popular, but other inorganic and polymeric materials are commercially available. In addition to the generic phases shown in **Table 9.1**, specialty phases are available for specific analytes, which will be covered in detail in Chapter 10.

Silica-based SPE cartridge packings are of somewhat lower quality and lower cost compared to corresponding HPLC packings. Whereas "basic" column packings with minimal silanol interactions are preferred in reversed-phase HPLC, RP-SPE packings will generally be more "acidic" (Type A), and their silanol interactions may tend to be more pronounced and more variable from lot-to-lot. However, because SPE is usually practiced as an "on-off" or "digital" technique, small differences in retention may be less important than in HPLC where subtle selectivity differences must be exploited to obtain baseline separation.

An SPE packing should be selected (**Table 9.1**) that will retain the analyte strongly during sample loading (**Figure 9.8.2**). Ionic or ionizable samples suggest the use of ion exchange packings, especially since the analyte can often be eluted with an aqueous mobile phase, by a change in pH, or an increase in ionic strength. For ion exchange SPE applications, the analyte fraction can then be injected directly onto a reversed-phase HPLC column, after pH adjustment to minimize analyte ionization and optimize its reversed-phase retention. Neutral analytes can be separated on either reversed-phase or normal-phase SPE packings. Normal phase or some of the newer hydrophilic interaction liquid chromatography (HILIC)-type packings are recommended for more polar analytes; RP-SPE packings are best for less polar, more hydrophobic analytes. Normal phase solvent systems are generally more compatible with gas chromatography columns.

Some polymeric packings with appropriate surface chemistries offer a controlled and balanced combination of hydrophilic and hydrophobic character, and allow neutral, basic, and acidic analytes to be isolated by adjustment of pH, ionic strength, and solvent conditions. In addition, the polymeric phases display a wider pH range than silica-based sorbents and therefore offer more flexibility during method development. In fact, often generic method development protocols can be used with polymeric packings where there is a high probability of success without rigorous method development investigations.

# Practical Guidelines for Method Development

In order to have a rugged and robust SPE method, a systematic approach should be used to ensure that one reaches the goals of maximum analyte purity, recovery, and reproducibility. Each of the four steps of SPE must be optimized during the process of method development. **Figure 9.9** gives a generic, systematic approach to addressing each of the steps that should be performed in successful method development. In SPE, one must consider all of the possible molecular interactions depicted in **Table 9.2** and in **Figure 9.10**. By choosing the appropriate mode (e.g. adsorption, reversed-phase, ion exchange, etc.), sample capacity and retention characteristics of the sorbent, choice of the solvents, buffers, pH, etc. used in the various steps, the flow rate, temperature, and other experimental parameters, one can reach the goals of SPE.

Table 9.2

General Classes of SPE Phases
<b>Non-polar phases (reversed-phase)</b> Hydrophobic/non-polar interactions
<b>Polar phases (normal phase)</b> Polar (H-bonding or dipole-dipole) interactions
<b>Ion exchange phases</b> Electrostatic interactions
<b>Covalent</b> PBA (See Chapter 10)

Before starting SPE method development, it is important to ask a number of questions about the sample and the goals of the final analysis. At the end of Chapter 1 in this book, there are worksheets that provide a series of questions that may aid you in setting up your sample preparation method to meet the needs of the analysis. Answers to these questions can help to facilitate SPE method development.

Figure 9.9

## Systematic SPE Method Development

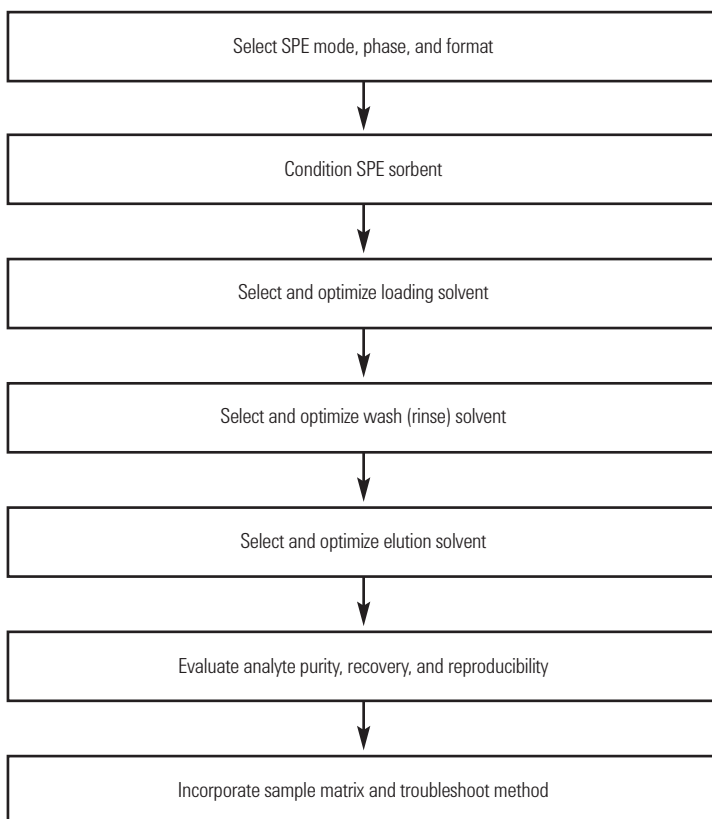
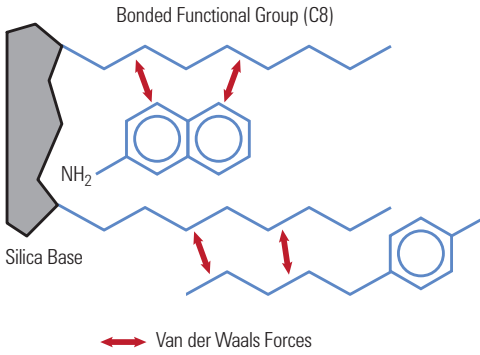

Figure 9.10

## Non-Polar Interactions

Figure 9.10A



## Ion Exchange Interactions

Figure 9.10C

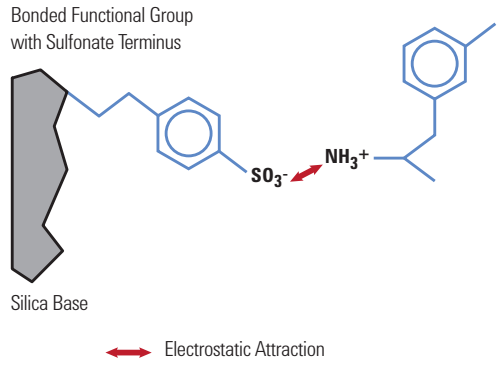

## Polar Interactions

Figure 9.10B

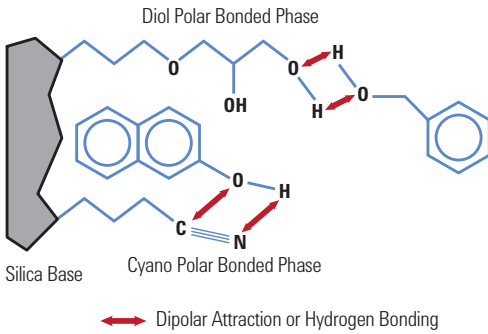

## Mixed Mode SPE

Figure 9.10D

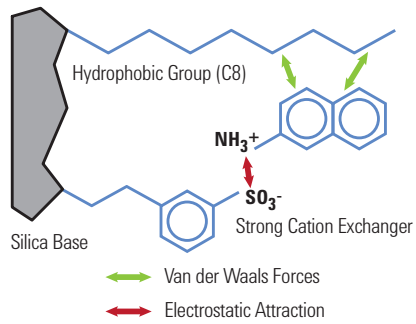

**Research the Problem:** SPE has been around for a long time and there are thousands of publications in literature, textbooks, internet, applications bibliographies, and manufacturers' websites. There is a good chance that your analyte (or type of analyte) and matrix has already been addressed. You can save yourself a great deal of time to start with the SPE conditions already worked out. A literature search on SPE methods for similar analyte-matrix pairs may also prove to be useful. SPE cartridge manufacturers have published extensive bibliographies (some in searchable electronic database formats such as the Agilent Technologies ScanView) that can help to locate publications of interest or provide initial conditions. Also, some manufacturers provide application notes for the same or similar compounds, and some offer consulting services for SPE method development. At the end of this chapter, there is a list of books that have been written on the subject – a good place to start for both method development and applications information.

**Characterize the Analyte(s):** In many cases, you know the structure and perhaps some of the chemical and physical properties of the analyte. The analyte's functional groups and polarity and other chemical properties can dictate the SPE mode that will allow maximum retention. Parameters such as its solubility in various solvents, stability, pKa, log P (octanol/water partition coefficient), etc. can help to maximize (or minimize) retention on the selected stationary phase. The concentration of analyte will have a profound effect on the experimental approach used to isolate it. Analyte concentrations in the parts per billion or lower present challenges in recovery, purity, and reproducibility while high analyte concentrations simplify method development and make the task much easier.

**Characterize the Sample Matrix:** Knowledge of the sample matrix is important in selecting the appropriate loading, washing and elution conditions. If the matrix is quite different than your analyte of interest, it may make method development easier. Possible compounds that have similar functional groups or pKa to your analyte can make method development more difficult. Knowledge of the matrix solubility characteristics, stability, pH, ionic strength, etc. can give one an idea of mode selection.

**Develop or Apply Effective HPLC or GC Method:** Obviously, one needs an analytical method to monitor the progress of method development to determine purity, recovery, and reproducibility. Sometimes, because of the similarity of SPE and HPLC, the development of a successful analytical method for HPLC gives one an idea of the mode, stationary phase selection, and retention characteristics that can be employed for SPE. Due to its nature, the gas chromatography method is less effective in helping to decide on a likely SPE stationary phase.

**Conditioning the SPE Packing:** See earlier in this chapter to review the importance of conditioning the SPE packing (see *Practice of SPE*, Step 1) since the stationary phase must be properly solvated to receive the sample.

Methanol is commonly used as the conditioning solvent for RP-SPE packings or polar-bonded phase packings such as cyano, amino, and diol. However, MeOH should not be used for silica gel, which is strongly deactivated by this solvent; an intermediate-polarity solvent such as methylene chloride or a non-polar solvent (e.g. hexane) is recommended for unmodified silica.

After the packing is conditioned, the excess methanol (or other conditioning solvent) should be removed by a flow of air through the cartridge until solvent drops no longer drip from the bottom of the cartridge (step 1A, not depicted in **Figure 9.8.1**). However, the air flow should not be continued past this point, as this can affect analysis reproducibility (especially with SPE disks). It is better to leave a slight amount of conditioning solvent in the bed than risk drying out the bed. If the silica-based SPE packing is allowed to dry out before the sample is introduced, the conditioning step should be repeated before proceeding. Polymeric packings such as Agilent's Plexa products are more forgiving in this respect. With RP-SPE separations, removal of excess methanol can also be accomplished by purging the cartridge with a solvent that is miscible with the conditioning solvent and the sample; for example, water or buffer. A preconditioning water wash (step 1, **Figure 9.8.1**, Solvent "D") also serves to ready the SPE cartridge for introduction of an aqueous sample (step 2, **Figure 9.8.2**). Do not allow too much time (more than a few minutes) between this water conditioning step and the sample loading step because if the packing sits in water too long the solvating solvent may slowly be partitioned into the water, thereby "de-solvating" the hydrophobic bonded phase.

**Select/Test Sorbents and Loading Solvents:** Once the mode is selected, the sorbent that provides maximum analyte retention in the sample solvent should be determined. There are many different sorbents available for all modes. To maximize analyte retention in step 2 (**Figure 9.8.2**), the sample-solvent should be a "weak" solvent for the analyte packing combination. In some cases, the sample is presented as a solution, and the question is whether to leave the sample "as is" or to exchange the original solvent for a new solvent. Convenience is usually an important consideration, suggesting use of the original sample-solvent if possible.

For reversed-phase SPE packings (**Figure 9.10A**), water (buffered) is the preferred loading solvent, with as little added organic as possible (remember to consider the added internal standard). Thus, if your sample is an aqueous solution and contains mostly non-ionic components, RP-SPE is often the preferred choice. For normal phase packings (**Figure 9.10B**) on silica, alumina, or polar-bonded phases (e.g. cyano, diol, amino), hexane or another saturated hydrocarbon is the preferred solvent; the less polar the sample-solvent, the better. Thus, if your sample is dissolved in a hydrocarbon solvent or other non-polar organic, normal phase SPE can be used. For ion exchange packings, the preferred sample-solvent is water (although small amounts of organic are not a problem and can be tolerated by the packing material) at the lowest possible ionic strength. If the sample contains ionic or ionizable analytes that are dissolved in water or a buffer, then either RP-SPE- (**Figure 9.10A**), ion exchange- (**Figure 9.10C**), or mixed-mode- (**Figure 9.10D**) phases are applicable. The latter phases can help to "fine tune" the SPE cleanup and have become very popular in recent times. For example, a phase that includes both ion exchange and reversed-phase (RP) characteristics can be used to advantage in the cleanup of ionizable analytes with hydrophobic functionality using two different mechanisms. Also, an SPE cleanup that is "orthogonal" to the HPLC analytical column (i.e., has different selectivity or sorption characteristics) is likely to result in less overlap of analyte peaks by interferences.

For an RP-SPE cartridge, when the sample contains ionizable analytes such as organic acids or amines, a change in pH (rather than a change of solvent) can be used to retain (steps 2 and 3) and remove (step 4) compounds. For example, an organic-acid analyte can be retained in its non-ionized (neutral) form (with  $k > 1$ ) by using a low-pH water-organic buffer for the initial wash solvent "W" (step 3); e.g., 30% ACN/low-pH buffer. Polar, ionic impurities and protonated bases will be washed from the cartridge and discarded. The analyte can then be eluted in a small volume by increasing the pH of the 30% ACN/buffer wash solvent so that  $pH > pK_a$ ; the analyte is fully ionized, and  $k \ll 1$  (step 4).

Due to the nature of the electrostatic interactions, ion exchange can be a powerful and selective SPE technique for ionic and ionizable compounds. Cation exchange packings are used for protonated bases and other cations, while anion exchange packings are used for ionized acids and other anions. Ion exchange packings come in two forms: "strong" and "weak"; strong ion exchangers are normally preferred, if strong retention of the analyte is the main objective. Retention of weak ion exchangers is a function of pH. Choice of pH is a compromise between maintaining the ionic character of the stationary phase while ensuring that the ionic analyte remains in an ionic state. For example, using a carboxylic acid weak cation exchanger for the separation of protonated amines, the pH must be selected to ensure that the amine is in its protonated form (cationic) while the carboxyl group is negatively charged (anionic). Thus, pH becomes a powerful variable in optimizing retention or in releasing retained analyte from a weak ion exchanger. Weak anion or weak cation exchange SPE phases are most effective for analytes that are ionized at all pH values (e.g. analytes with quaternary ammonium functionality and with sulfonic acid functionality, respectively).

In some cases, to select an appropriate sorbent, an empirical approach is often followed. For example, based on the known characteristics of the analyte, several SPE phases are possible choices. Each of these phases can be tested for the retention of analytes and interferences allowing an optimum choice of SPE sorbent. SPE method development kits that provide a number of phases for scouting are available. These kits provide several different stationary phases and are in all SPE formats: cartridges, disks, pipette tips, or 96-well formats. With flexible 96-well plates, a user can build a custom plate configuration consisting of different sorbents in each row of wells. By scouting the different sorbents, an optimum sorbent phase can be chosen. Once the optimum phase is chosen, the user can then purchase entire boxes of this optimum stationary phase for the final method. To make the optimum phase and solvent selection easier, automated instrumental SPE systems are also available that can be programmed to look at a number of SPE phases and automatically investigate not only the various loading solvents, but also the wash and elution solvent conditions on these phases.

The next consideration is to select the appropriate cartridge size and mass of stationary phase sorbent. The volume of sample that can be applied to the SPE cartridge depends on (a) the size and type of cartridge (weight of packing), (b) retention of the analyte in the sample-solvent, and (c) the concentrations of both analyte and interferences in the sample. Often, it is desired to apply as large a sample volume as possible to maximize the concentration of analyte in its SPE fraction for optimum detection sensitivity in the following chromatographic separation. Although using a larger cartridge allows a larger sample volume, this may not affect detection sensitivity, since the maximum analyte concentration in the SPE fraction is determined by the sample-volume/packing-weight ratio. Therefore, when the amount of sample available is small, the smallest possible SPE cartridge will be preferred. The capacity of the cartridge for analyte plus interferences is roughly 10-20 mg per g of packing. For ion exchange SPE sorbents, the manufacturer usually supplies the total ion exchange capacity in microequivalents/gram so that one can ensure that the sample load does not exceed exchanger capacity.

Once the cartridge size has been selected, the maximum sample volume that can be applied must be determined. An important but often overlooked parameter to be investigated is sample breakthrough. The sorbents used in SPE have a finite sample capacity. Placing too large of a sample mass or volume on the SPE device can result in loss of analyte, resulting in low recovery. The “sample” in this case is the total contribution of the analyte, the interferences, and the matrix since all components of the sample occupy sorbent active sites. To determine the breakthrough, a sample solution is pumped through the SPE device at a slow flow rate (1-2 mL/min) while monitoring the baseline with a UV detector or other detector that can measure all sample components. An alternative method is to apply (or pump) a large volume of sample and collect small fractions. The fractions are then assayed for the analyte by HPLC or GC, to determine the maximum sample volume before breakthrough of the analyte. When carrying out this experiment, the analyte concentration chosen should be the maximum value expected in the sample. (If the composition of the sample matrix is likely to vary, the allowable sample volume can also vary).

As **Figure 9.11** shows, the sample will eventually saturate the stationary phase and elute from the exit of the cartridge. The breakthrough volume ( $V_B$ ) represents the point where the breakthrough begins.  $V_M$  represents the maximum volume of sample in a particular loading that can be placed onto the SPE device. By knowing the concentration of the sample and the flow rate, one can calculate the mass of sample that can be handled by a particular weight of sorbent. Ensure that this mass is not exceeded; otherwise analyte loss may occur and the recovery will be decreased. Note that the final sample-volume selected should be somewhat smaller than the value determined in this way, to allow for removal of impurities in step 3 without loss of analyte.

Figure 9.11

### Breakthrough Curve for SPE Device

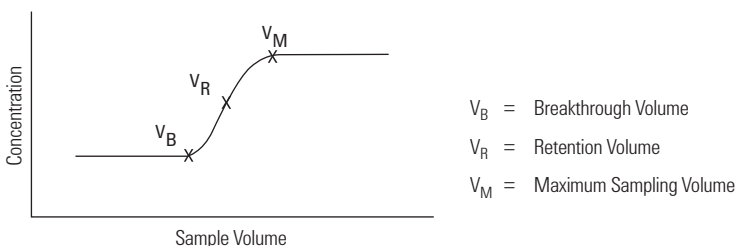

**Determine Wash (Rinse) Solvents:** The object of this step (**Figure 9.8.3**) is to remove as much as possible of the early-eluting interferences. This goal can be achieved by selecting a wash solvent “W” that provides intermediate retention of the analyte; e.g.,  $3 < k < 10$  under the conditions of separation (in the presence of the sample matrix). The analyst should use as large a volume of wash liquid as possible to remove early-eluting impurities while retaining the analyte on the cartridge. This optimum wash-solvent volume can be determined in the same way that the maximum sample volume is determined (see above), by collecting fractions and assaying them for the analyte.



There are two approaches for determining the best composition of the wash solvent:

First, when using HPLC, SPE method development seldom begins before there is a method for the analyte standard. If the same kind of packing is intended for both SPE and HPLC, the HPLC retention data can provide an initial estimate for the composition of the wash solvent. If the HPLC mobile phase is 30% ACN/buffer (ACN is acetonitrile), then the analyst should start with 30% ACN as the wash solvent. If the analyte begins to leave the column before 5-10 cartridge volumes of wash solvent have been collected and analyzed (1 cartridge volume ( $\mu\text{L}$ ) = mg of packing), the wash solvent is too strong. Decrease % ACN and repeat the experiment.

A second approach is to apply the sample, then wash the cartridge with 5-10 bed volumes of successively stronger solvent (e.g. 25%, 50%, 75%, 100% organic or – in normal phase SPE – a series of pure solvents with increasing solvent power, higher P' value). Monitoring the extraction effluent at each concentration will determine the elution profile of the sample.

Remember, the most effective wash solvent is one that will not elute the sorbed analyte yet allow interferences to be removed. For ionizable interference/matrix compounds, adjusting the pH of the wash solvent can be an effective way to moderate the retention/release of the interferences (e.g., acidic compounds will be more retained at low pH, and less retained at high pH, while basic compounds will be more retained at high pH and less at low pH).

**Determining the Elution Solvent:** The object of this step is to collect all of the analyte in the smallest possible volume, while at the same time excluding as much as possible of late-eluting interferences. A further goal is to obtain the analyte fraction in a form that can be injected directly onto the HPLC or GC column. For HPLC analysis, these various goals are mutually contradictory. The use of a very strong SPE elution solvent "E" (so that  $k \ll 1$  for the analyte), minimizes sample volume, but makes it less likely that a large volume of the analyte fraction can be injected onto the HPLC column. An elution solvent just strong enough to elute the analyte with some retention (e.g.,  $k \approx 2$ ), minimizes contamination of the analyte fraction by late-eluters, but increases the volume and makes it less likely that the total analyte fraction can be injected directly. Use of a less hydrophobic RP-SPE packing (e.g., cyano) can minimize this problem. When late-eluting interferences are a problem, the best approach is elution of the analyte with  $1 < k < 5$ . If detection sensitivity is critical so that all the analyte must be injected for HPLC, evaporation to dryness and re-dissolution of the analyte fraction may be required. Evaporation of aqueous samples is inconvenient, so lyophilization is an alternative. If normal phase SPE is used, the analyte fraction will be in an organic solvent that is more easily removed by evaporation. Normal phase SPE separation is also less likely to retain less-polar compounds that tend to elute late in reversed-phase HPLC.

If the analyte is an acid or base, solvent strength in the washing and elution steps of RP-SPE can be adjusted by means of a change in pH, as discussed earlier. This approach makes it easier to select conditions that allow direct injection of the total analyte fraction, without contaminating the analyte fraction with late-eluters that will increase HPLC (or possibly GC) separation times. SPE with ion-exchange packings is even more likely to furnish an ideal analyte fraction for subsequent HPLC analysis. Because of packing dissolution and degradation, users are advised that silica-based HPLC columns generally should not be used outside a pH-range of about  $2 < \text{pH} < 8$ . However, the one-time use of SPE cartridges allows a wider range of pH. The presence of a tiny amount of dissolved silica or hydrolyzed bonded phase is unlikely to interfere with the subsequent HPLC or GC analysis. If dissolved silica in the analyte fractions is a problem, polymeric SPE cartridges are stable for  $1 < \text{pH} < 14$  and may be a better choice.

**Test Blank and Fortified Matrix:** Once the method is optimized for analyte recovery, purity and reproducibility, a fortified matrix as well as a blank should be run using the optimized wash and elution solvents.

When using SPE, it is important to run blanks to rule out potential contamination by extractables from the cartridge body, frits, and packing materials. If contamination from these materials is suspected, the cartridge should be rinsed with organic solvent (e.g. methanol, acetonitrile) or dilute acid (e.g. 0.1% formic acid) prior to use.

**Test Real Samples and Fortified Samples:** The method should now be tested with real and spiked samples to see if analyte purity, recovery, and reproducibility are affected. If so, further refinements in the method need to be made.

To assist in method development, **Figure 9.12** provides a method development flow chart that addresses the basic steps in performing the SPE experiments. This flow chart guides one through the main steps in developing an SPE method. Using this flow chart along with **Tables 9.1 and 9.2** and **Figures 9.8 and 9.9**, one should be able to begin the process of method development: choosing the proper SPE phase, conditioning solvent, loading solvent, washing solvent, and finally, the elution solvent. For very complex samples, additional sample preparation protocols may be required prior to or after the SPE cleanup. Difficult interferences can be removed by other sample preparation techniques shown on the left hand side of the flow chart. However, often an optimized SPE method provides a sufficiently clean sample for direct analysis. The high selectivity and sensitivity of tandem mass spectrometry has allowed simpler sample preparation protocols to be used.

Figure 9.12

## Method Development Flow Chart for SPE

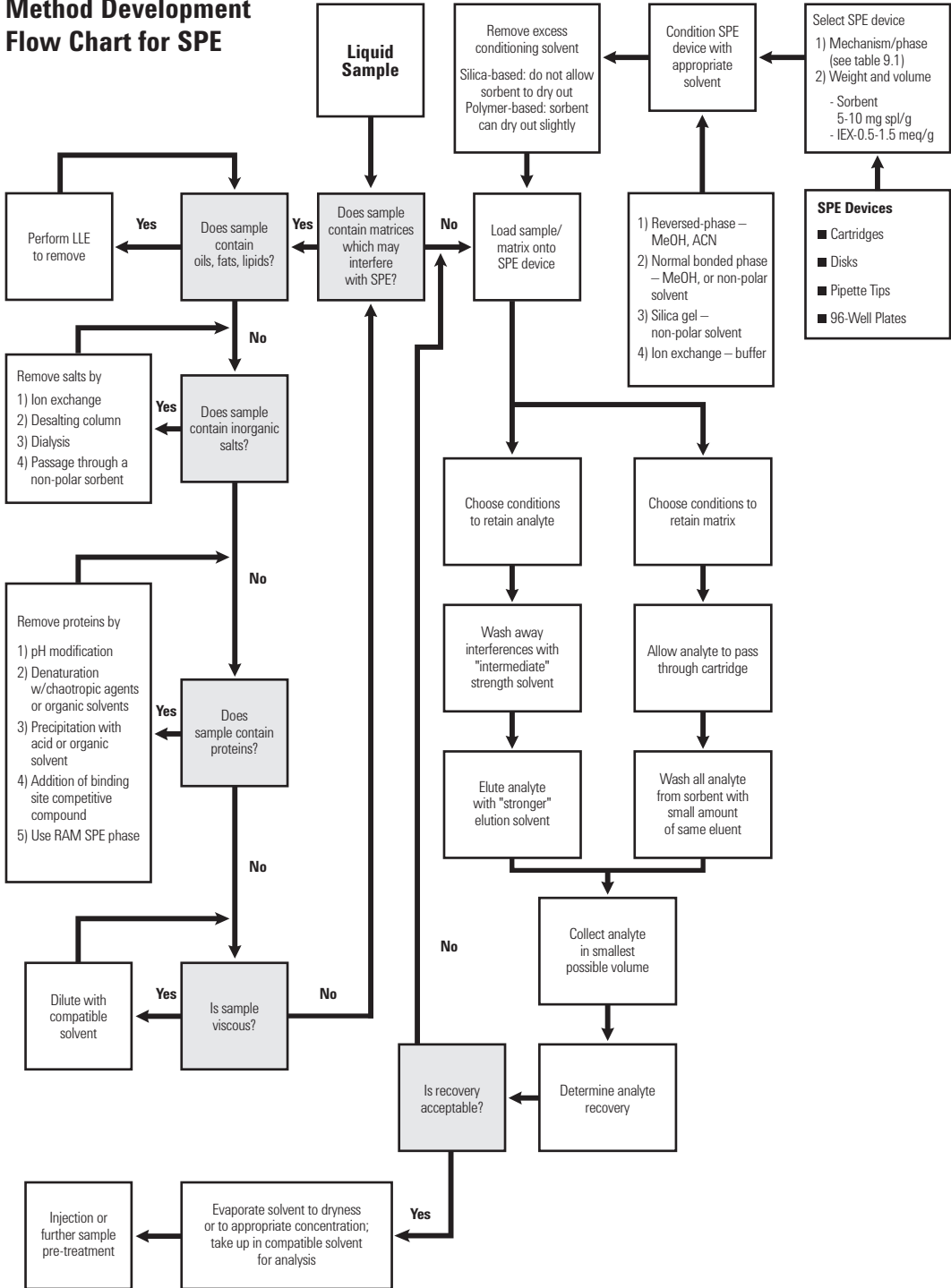

# Method Validation

Once an SPE method is developed, validation may be required (or to evaluate method robustness if a full validation is not required). Some of the variables that should be considered when validating a method are depicted in **Table 9.3**. **Figure 9.13** shows one of the more important investigations that should be conducted – the effect of flow rate and recovery in SPE, especially for the loading, washing, and elution steps. There is a kinetic element in sorption. The analyte needs time to diffuse into the porous SPE support and interact with the active functional group. If the flow rate is too fast, there is insufficient time for this equilibrium to occur. Too slow of a flow rate will just waste time. The flow rate for ion exchange SPE is even more important since ion exchange kinetics can be rather slow. Typically, a flow rate of 5 mL/min or less for adsorption and normal phase cartridges and 1-2 mL/min for ion exchange phases is sufficient for a typical cartridge format (e.g. 200 mg/3 mL).

Table 9.3

Variables to Consider in SPE Method Validation	
Test Required	Experimental Parameter(s) to be Investigated
Sorbent	Weight, cartridge format, different lots
Conditioning Solvent	Solvent strength (weak or strong solvent), contact time, volume
Loading Solvent	Type, volume, % organic, pH, ionic strength, flow rate, breakthrough volume, analyte recovery/loss, interference/matrix removal
Wash Solvent	Type, volume, % organic, pH, ionic strength, flow rate, analyte recovery/loss, interference/matrix removal
Elution Solvent	Type, volatility, solvent strength, volume, flow rate, pH, ionic strength, interference/matrix retention, analyte recovery/loss
Analyte and Matrix Stability	Tested in each step of method
Sample/Matrix Loadability	Different analyte concentrations
Detectability	Limits of detection (LOD), limits of quantitation (LOQ)
Method Linearity and Range	Tested over expected concentration range of analyte, test as function of matrix loading

Figure 9.13

## Relationship Between Sample Recovery and Flow Rate in SPE

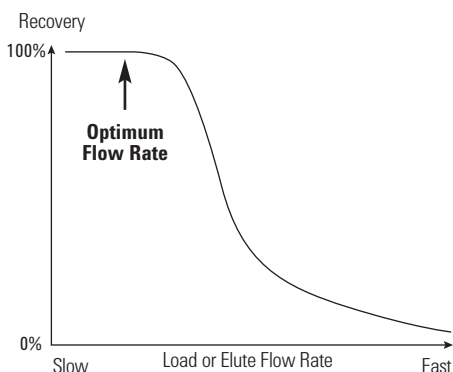

## SPE Application Examples

Some examples of the use of SPE to solve “real world” problems will be covered. Synthetic sweeteners are sugar substitutes increasingly being used to combat obesity and dental decay. Research has shown that some artificial sweeteners can cause tumors in certain animals<sup>21</sup>. Sewage treatment plants do not completely remove artificial sweeteners from wastewater and these pollutants contaminate waters downstream and may be present in drinking water. Solid phase extraction using a neutral polymeric sorbent can be very useful for isolating and concentrating organic contaminants in large volumes of water samples. These sorbents have very high affinity for organics and exhibit good recoveries from an aqueous environment. In the studies of Junginger and Korte<sup>22</sup>, they investigated using 200 mg/6 mL cartridges containing the SPE sorbent Bond Elut Plexa (Agilent Technologies) to isolate four synthetic sweeteners (acesulfame, cyclamate, saccharin, and sucralose) each at the 1 ppb level in water. The SPE cartridge was first conditioned with 3 mL of methanol followed by 3 mL of acidified HPLC water. The water sample (100 mL) was acidified with sulfuric acid at pH 2 and loaded at a flow rate of 5 mL per minute. No rinsing step was required in this trace enrichment experiment. Elution of the analytes from the cartridge was performed with 5 mL of methanol at a flow rate of 2 mL per minute. The solvent was evaporated to near dryness stream of nitrogen and reconstituted in 1 mL of acetonitrile:water (5:95). Using an Agilent ZORBAX Eclipse XDB-C18 HPLC column (4.6 x 50 mm, 1.8  $\mu$ m) and a water-methanol gradient, the four sweeteners could be separated to baseline in just over 5 min using tandem mass spectrometric detection. Recoveries of the four sweeteners for a 20  $\mu$ L injection volume ranged from 74-91% and RSDs averaged around 7%, quite acceptable at these low concentrations.

Fungi of the genus *Alternaria* are pathogens of various plants such as fruits and vegetables. *Alternaria* is a frequently occurring species of particular interest because it produces a number of harmful mycotoxins, including alternariol (AOH), alternariol monomethyl ether (AME), altenuene (ALT), tentoxin (TEN) and tenuazonic acid (TEA). These toxins can be found in grain, seeds, pepper, and various fruits. Their determination is important for food safety. First, these toxins must be extracted from the food source, then cleaned up and concentrated by the SPE. Reinhold and Bartels<sup>23</sup> developed the workflow for the sample preparation shown in **Figures 9.14 and 9.15**. Again, the Bond Elut Plexa polymer provided excellent cleanup of toxin extracts from vegetable and grape juice samples. Using ternary gradient elution and reversed-phase HPLC with mass spectrometric detection, a baseline separation was achieved in 15 min as depicted in **Figure 9.16**. The SPE cleanup reduced ion suppression effects in the mass spectrometer. For the method, the limit of detection was 5 µg/L while the limit of quantitation was 10 µg/L. Typical recoveries for the *alternaria* toxins from grape juice ranged from 97-105%. RSDs ranged from 1-3.6%.

Figure 9.14

### Initial Workflow for Extraction of *Alternaria* Toxins

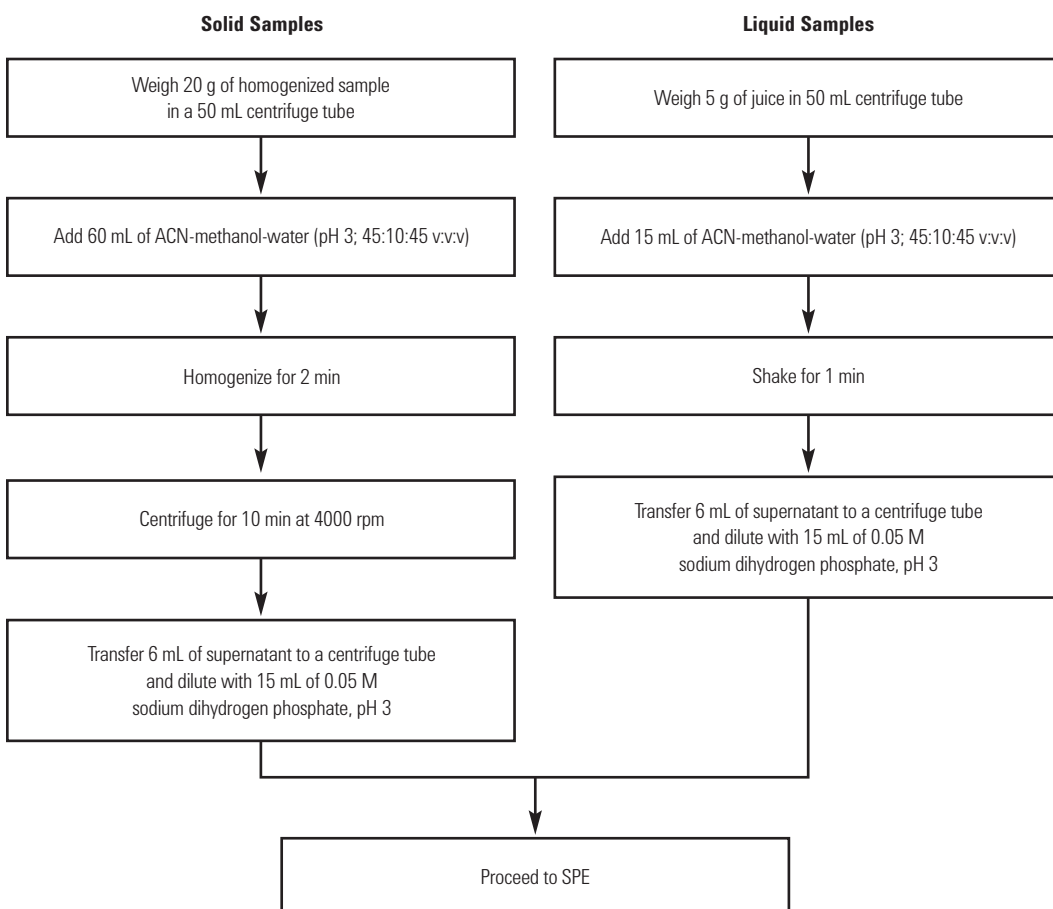

Figure 9.15

### Workflow for SPE Cleanup of Alternaria Toxin Extracts

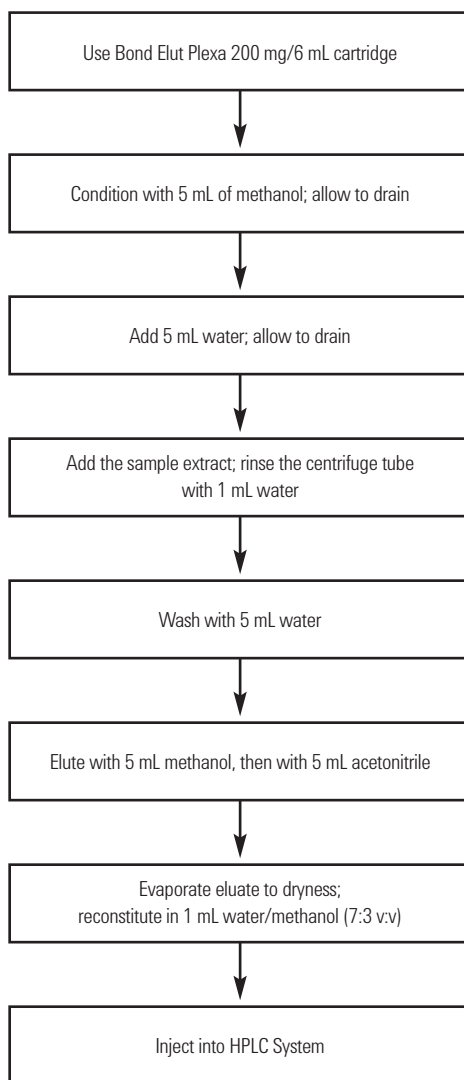
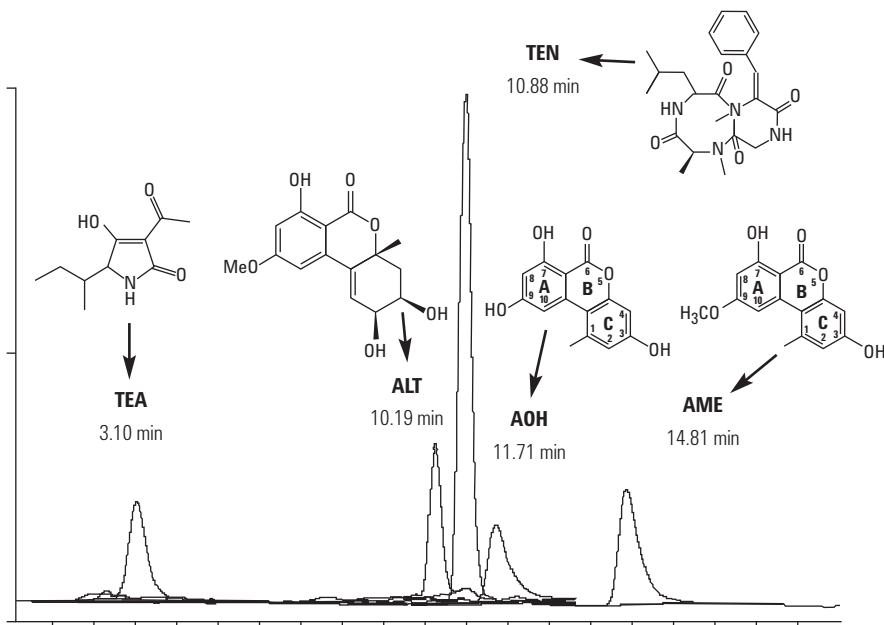

Figure 9.16

### LC/MS Chromatogram of Alternaria Toxins from Grape Juice Extract\*



\* Grape juice spiked at 25 µg/kg concentration

Polymeric sorbents such as Bond Elut Plexa allow the development of generic SPE methods. Generic methods often save time in applying SPE cleanup to difficult samples. The cleanup of acid, base, and neutral compounds in biological fluids is one area where these generic methods have found great utility. A significant number of bioanalytical compounds in the pharmaceutical industry are basic and can be easily extracted using hydrophobic or cation exchange sorbents. However, lipid lowering statins and anti-inflammatory drugs tend to be acidic and can be problematic when using traditional hydrophobic sorbents. A simple generic method was developed for the analysis of the acidic compounds statins in spiked plasma using Plexa PAX, a strong anion exchanger that can operate at high pH values due to its polymeric nature<sup>24</sup>. The Plexa PAX resin was used in a 96-well plate configuration. Each well contained 30 mg of the ion exchange resin. The SPE method was rather simple: 100 µL of human plasma was first diluted 1:3 with 2% ammonium hydroxide solution. Each well was conditioned with 500 µL of methanol followed by 500 µL of water. The diluted plasma sample containing the spiked statins was added to the resin in the well. After sample application, the Bond Elut Plexa PAX was washed first with 500 µL of water followed by 500 µL of methanol. Elution was performed by adding 500 µL of 5% formic acid in methanol to the 96-well plate. The eluate was collected, evaporated to dryness, and reconstituted in 1 mL of 5 mM aqueous ammonium formate:methanol (80:20). Using a reversed-phase HPLC-LC-MS/MS and gradient elution of the following five statin drugs: atorvastatin, diclofenac, furosemide, ketoprofen, and pravastatin spiked at the 50 ng/mL level were separated in just over 3 min. All five statins showed linear calibration curves over the range 0.5-200 ng/mL. Analyte recoveries were determined by measuring analyte response compared to a spiked mobile phase standard. Recoveries ranged from 62% for atorvastatin to 96% for furosemide with RSDs (n=6) ranging from 2.3-6.1% at the 50 ng/mL level.



# Recommended Textbooks on SPE

Space requirements allow this chapter to provide only a basic introduction to SPE. Chapter 10 provides information on more specialized SPE phases. For general reading, entire books have been written on SPE<sup>25-32</sup> including its automation<sup>33</sup>. The reader is directed to those references for more detailed coverage of the subject.

## References

---

1. Diaz-Ramos, M.C.; Suarez, A.; Rubies, A.; Companyo, R.; Korte-McIlrick, E. *Determination of 24 PAHs in Drinking Water*, Agilent Technologies Application Note #5990-7686EN, **2012**.
2. Gledhill, S. *High Sensitivity Detection of Pesticides in Water Using On-line SPE Enrichment*, Agilent Technologies Application Note #5991-08871EN, **2012**.
3. Hudson, W.C.; Massi, J. M. *Protein Desalting and Concentration for MS Analysis Using Agilent Bond Elut OMI X C4 Pipette Tips*, Agilent Technologies Application Note #5990-8885EN, **2011**.
4. Baños, C.-E.; Silva, M. *Talanta* **2009**, *77* (5), 1597-1602.
5. Ochoa, M.L.; Harrington, P.B. *Anal. Chem.* **2005**, *77* (3), 854-863.
6. Henriksen, T.; Svensmark, B.; Lindhardt, B.; Juhler, R.K. *Chemosphere* **2001**, *44*, 1531-1539.
7. Alfred-Stevens, A.; Eichelberger, J.W. *Methods for the Determination of Organic Compounds in Drinking Water* (Supplement I), Environmental Monitoring Systems Laboratory, Office of R&D, U.S. EPA, Cincinnati, OH, **1990**, 33-63.
8. Fenn, J.B. et.al. *Science* **1989**, (246), 64-71.
9. Karas, M. *Anal. Chem.* **1988**, (60), 2299-2301.
10. Thomas, R. *Spectroscopy* **2001**, *16* (1), 28-37.
11. Majors, R.E. *LC.GC* **2005**, *23* (4), 358-369.
12. Majors, R.E.; Shukla, A. *LC.GC No. America* **2005**, *23* (7), 646-660.
13. Kataoka, H.; Lord, H.L.; Pawliszyn, J. *J. Chromatogr. A* **2000**, *880*, 35-62.
14. Pawliszyn, J. *Solid-Phase Microextraction: Theory and Practice*, Wiley-VCH, **1997**, 264 pp ISBN-10: 0471190349 and ISBN-13: 978-0471190349.
15. David, F.; Tienport, B.; Sandra, P. *LCGC No. America* **2003**, *21* (2), 108-118.
16. Baltrussen, E.; Sandra, P.; David, F.; Cramers, C.A. *J. Microcol. Sep.* **1999**, *11*, 737.
17. Popp, P.; Bauer, C.; Wennrich, L. *Anal. Chim. Acta*, **2001**, *436* (1), 1-9.

(Continued)

## References (Continued)

---

18. Snyder, L.R. *J. Chromatogr. Sci.* **1978**, *16*, 223.
19. Snyder, L.R.; Kirkland, J.J.; Dolan, J.W. *Introduction to Modern Liquid Chromatography*, 3rd Ed., Chapter 2 and Appendix I.2, John Wiley and Sons, Hoboken, NJ, **2010**.
20. [http://www.epa.gov/epawaste/hazard/testmethods/sw846/online/3\\_series.htm](http://www.epa.gov/epawaste/hazard/testmethods/sw846/online/3_series.htm)
21. Takayama et al. *Long-Term Toxicity and Carcinogenicity Study of Cyclamate in Nonhuman Primates*, *Toxicol. Sci.* **2000**, *53*, 33-39.
22. Junginger, S.; Korte, E. *Analyzing Synthetic Sweeteners in Wastewater With Robust Sample Preparation*, Agilent Technologies Application Note #5990-8248EN, **2011**.
23. Reinhold, L.; Bartels, I. *LC-MS/MS Determination of Alternaria Toxins in Vegetables and Fruit Beverages*, Agilent Technologies Application Note #SI-01322, **2010**.
24. Hudson, W. *Extraction of Acidic Compounds From Human Plasma Using Plexa PAX*, Agilent Technologies Application Note #5990-9027EN, **2011**.
25. Simpson, N.; van Horne, K.C. *Sorbent Extraction Technology Handbook*, Varian Sample Preparation Products, Harbor City, CA, **1993**.
26. Thurman, E.M.; Mills, M.S. *Solid-Phase Extraction: Principles and Practice*, John Wiley and Sons, New York, **1998**, ISBN-10: 047161422X and ISBN-13: 978-0471614227.
27. Fritz, J.S. *Analytical Solid-Phase Extraction*, Wiley-VCH, New York, **1999**, ISBN-10: 0471246670 and ISBN-13: 978-04712466.
28. Simpson, N.J.K. (Ed.) *Solid-Phase Extraction: Principles, Techniques, and Applications*, Marcel Dekker, New York, **2000**, ISBN-10: 082470021X and ISBN-13: 978-0824700218.
29. Telepchak, M.J. *Forensic and Clinical Applications of Solid-Phase Extraction*, Humana Press, Totowa, NJ, **2004**, ISBN-10: 0896036480 and ISBN-13: 978-0896036482.
30. Sadek, P. *Practical Solid-Phase Extraction: Fundamentals and Method Development*, Wiley-Interscience, New York, **2005**, ISBN-10: 0471329894 and ISBN-13: 978-0471329893.
31. Macwana, C.; Parmar, V. *Solid-Phase Extraction: Principle, Trends, Applications and New Developments*, LAP LAMBERT Academic Publishing, **2012**, ISBN-10: 3659206768 and ISBN-13: 978-3659206764.
32. Olariu, R-I.; Arsene, C.; Vione, D.; Grinberg, N. *Solid-Phase Extraction: Principles and Applications*, CRC Press, Boca Raton, FL, **2013**, ISBN-10: 1439868328 and ISBN-13: 978-1439868324.
33. Wells, D.A. *High-Throughput Bioanalytical Sample Preparation: Methods and Automation*, Elsevier Scientific Publishers, Amsterdam, **2003**.

# Special Topics in SPE

There are several topics closely related to the operating principles of SPE. These topics have become important in recent years as workers are seeking sample preparation techniques that use less organic solvent, are more selective, and may be automated for convenience and better reproducibility. This chapter will cover several of these techniques.

## Solid Phase Microextraction (SPME)

Solid Phase Microextraction is a relatively new sample extraction technique first described by Pawliszyn and coworkers in the early '90s<sup>1</sup>. In its most popular format, SPME consists of two discrete steps: solute absorption from the sample matrix into a thick layer of silicone or related adsorptive material coated onto a solid fused silica fiber (**Figures 9.5 and 10.1A**), followed by transfer of the sorbed analytes into a chromatography inlet by thermal- (GC) or liquid-desorption (LC).

SPME has been applied to both gas chromatography (GC) and liquid chromatography (LC) separations but its most successful application has been in GC. It eliminates the need for large-volume sample transfer into a GC column by concentrating analytes into the fiber coating while leaving the bulk of the solvent and non-volatile residues behind. In GC, SPME is considered to be a solvent-less sample preparation technique. In LC, the technique uses orders of magnitude less solvent than in liquid-liquid extraction and also uses less solvent compared to SPE.

A related technique, stir bar sorptive extraction (SBSE), first described by Sandra and coworkers<sup>2</sup> uses a magnetic stirring bar coated with a thick layer of absorptive polymer (see Chapter 9, *SPE Devices*). The stir bar is exposed to sample solution for a time, during which solutes are absorbed into the polymer coating. Subsequently, the stir bar is removed, dried, and then thermally desorbed for GC injection, or the absorbed analytes can be back-extracted with a different solvent for either LC or GC. SBSE uses a larger volume of stationary phase than SPME and, thus, is more efficient at extracting analytes with less absorbent solubility. Therefore, SBSE is generally more sensitive than SPME.

**Table 10.1** provides a sampling of the wide range of applications where SPME has been successfully used.

Table 10.1

<b>Typical Applications of SPME</b>		
<b>Analyte(s)</b>	<b>Matrix</b>	<b>Reference</b>
Fragrances	Flowers	3
Chemical warfare agents	Clothing material	4
Process impurities	Pharmaceuticals	5
Organochlorine pesticides	Chinese teas	6
Volatile compounds	Acidic media	7
	Cheese	8
Volatile phenols	Wine	9
Environmental pollutants	Water	10
Chloroanisoles	Cork stoppers	11
Volatile aliphatic amines	Air	12
Phenylurea herbicides	Aqueous samples	13
Sub-ppb phthalates	Water	14
Methyl mercury	Tuna fish	15
Volatile organic compounds	Soil	16
Isobutylpyrazine (MIBP or IBMP)	Wine	17
BTEX	Water	18
2-Methylisoborneol (2-MIB) and Geosmin	Drinking Water	19
Trichloroanisole	Wine	20

# SPME Principles

SPME relies on the extraction of solutes from a sample, usually aqueous, into an absorptive polymeric layer coated onto a solid fused silica fiber (**Figure 10.1A**). **Table 10.2** provides a listing of some commercially available fiber chemistries. After a sampling period, which may be of a considerable time (30 min or more) aided by stirring, the extraction reaches equilibrium. Then the SPME fiber and captured solutes are transferred into an inlet system that then desorbs the solutes into a gas (for GC) or liquid (for LC) mobile phase. Success relies on choosing conditions so that the desired solutes favor the SPME absorptive layer as much as possible in the presence of bulk sample. On the other hand, the absorbed solutes should be released during the desorption step as quickly and as completely as possible. If the desorption is slow and the desorbed solute peaks broad, a secondary trapping to refocus the analytes may be required. Then, in the case of GC by rapid heating, the refocused analytes are quickly swept into the chromatographic column for separation and analysis. The choice of the absorptive layer chemistry and film thickness strongly influences the degree of absorption and the subsequent efficiency of desorption. SPME fibers are available in syringe-integrated assemblies that are conveniently handled either manually or by robotic autosampling systems. Used fibers often can be cleaned up for reuse by solvent rinsing or baking. **Figure 10.2** depicts the entire extraction transfer and desorption process. Although solvent desorbing in a valve configuration can transfer solutes to an HPLC column, it is generally more convenient to perform the experiment off-line, then transfer the extracted contents to a vial or manually to a loop injector.

Figure 10.1

## Cross Sectional Diagram of SPME Extraction Devices

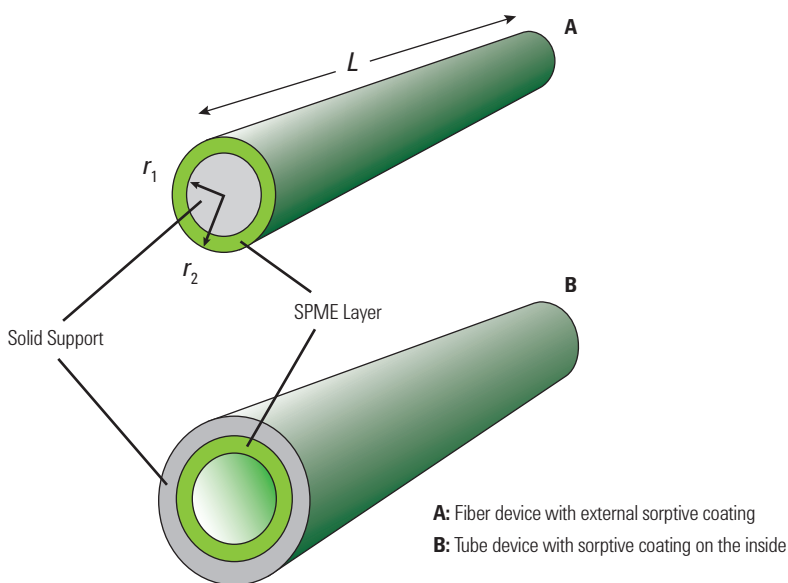

Adapted from <sup>21</sup>

Figure 10.2

## Steps in SPME Process in GC and LC

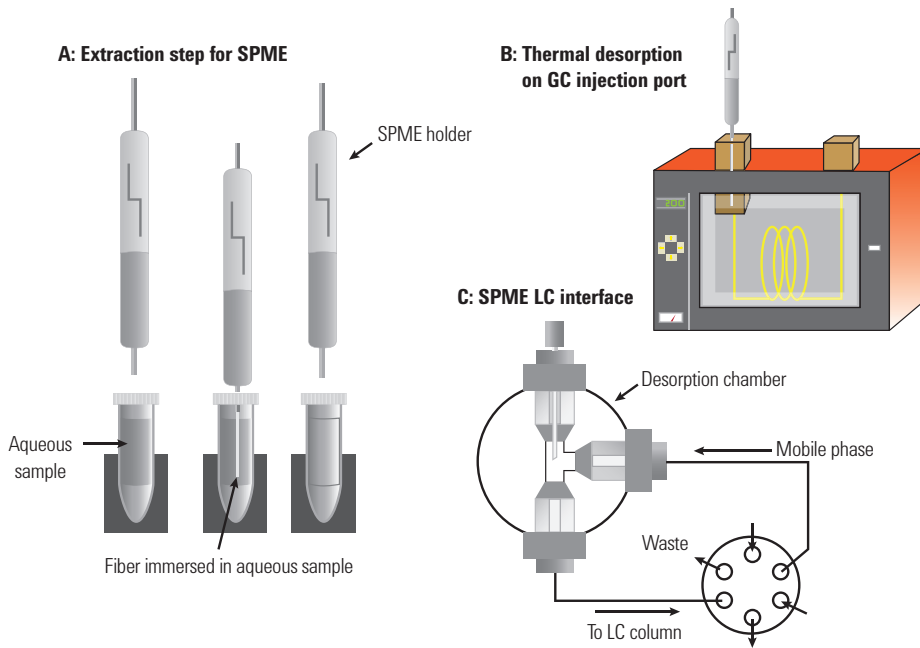

Table 10.2

### Types of Samples and Recommended Fiber Chemistry in SPME

Sample	Recommended Fiber Chemistry
Low molecular weight or volatile compounds	100 $\mu\text{m}$ polydimethylsiloxane (PDMS)
Larger molecular weight or semivolatile compounds	30 $\mu\text{m}$ PDMS fiber or a 7 $\mu\text{m}$ PDMS fiber
Very polar analytes from polar samples	85 $\mu\text{m}$ polyacrylate
More volatile polar analytes, such as alcohols or amines	65 $\mu\text{m}$ polydimethylsiloxane/divinylbenzene (PDMS/DVB)
Trace-level volatiles analysis	75 $\mu\text{m}$ PDMS/ Carboxen
Expanded range of analytes (C3-C20)	50/30 divinylbenzene/carboxen on PDMS
General HPLC	60 $\mu\text{m}$ PDMS/DVB

As an alternative approach to SPME, the stationary phase is coated on the inside of an open fused silica column (**Figure 10.1B**). Known as in-tube SPME<sup>22</sup>, mostly used for liquid chromatography, a solution containing the analyte of interest is pumped inside the coiled coated fused silica tube a number of times until equilibrium occurs. Then, after dispelling the sample liquid from the capillary tube, a strong solvent is used to displace the trapped analyte from the coated stationary phase into an HPLC loop injector.

Let's now look at the details of SPME extraction, transfer, and desorption. The following discussion was adapted from an article by J. Hinshaw<sup>21</sup>.

## Step 1: Extraction

For the extraction step with an externally coated SPME absorptive layer, the layer is exposed to sample in the liquid phase (**Figure 10.3A**) or gas phase (headspace) (**Figure 10.3B**). Over time, the amounts of solutes in the SPME layer reach an equilibrium level with their surroundings, which represents the maximum solute amounts that can be absorbed and withdrawn under a given set of sampling conditions. The amount of solute in the SPME layer at equilibrium ( $M_{i,SPME}$ ) can be approximated by the following equation:

$$M_{i,SPME} \sim K_{i,SPME} V_{SPME} C_i \quad \text{Equation 1}$$

where  $K_{i,SPME}$  is an aggregate solute distribution constant between the SPME absorptive layer and the sample,  $V_{SPME}$  is the volume of the SPME layer, and  $C_i$  is the solute concentration in the sample before performing SPME sampling.

**Figure 10.3**  
**SPME Extractions in Closed Vial**

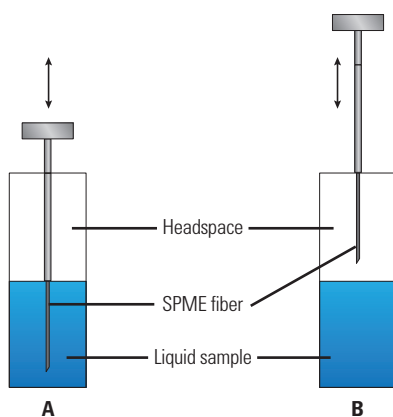

**A:** Sampling from the liquid phase

**B:** Sampling from the headspace (gas phase)

Equation 1 assumes that the sample volume is much greater than the volume of the SPME layer. SPME coatings typically have thicknesses of about 10-100  $\mu\text{m}$  typically around 10 times the film thickness range normally encountered in capillary GC columns. Standard SPME layers, with smaller volumes, would imply correspondingly smaller minimum sample volumes.

## Step 2: **Transfer**

The next step after sampling is to transfer the SPME layer and absorbed analytes away from sample exposure and into conditions for desorption into the chromatography mobile phase. For LC-SPME in-tube sampling with a multiposition valve connected to the SPME tube, there is no need to physically move the SPME layer, but new solvating conditions must be established in place that promote solute desorption. On the other hand, an SPME fiber device is removed from the sample container and transported over a distance to where the solutes are to be desorbed – the GC inlet or, in some cases, a solvent wash position. Removal from the sample environment immediately starts the absorbed solute concentrations shifting away from their in-sample values to lower levels as solutes naturally desorb into their surroundings. The rate of natural desorption is fairly low for many solutes, but volatile molecules could experience significant losses during the transfer step. In a laboratory situation, the transfer time from sample vial to instrument can be short enough so that losses are insignificant. Losses can be minimized during extended transport and storage by sealing the SPME layer into a small enclosure and then ensuring that the contents are included with the rest of the sample on desorption. In addition to volatile sample losses, an SPME layer can easily pick up non-sample components from the ambient air, especially during extended transportation from remote sites. Enclosing the SPME layer prevents the influx of such contaminants. A number of commercially available SPME devices incorporate such a sealing system.



### Step 3: **Desorption**

Once in place at a chromatograph, the SPME layer must then be exposed to conditions that cause the absorbed solutes to desorb with as close to 100% efficiency as possible, and in a sufficiently short time compatible with the chromatography mode in use. In the case of an SPME layer coated inside a tube, for LC analysis, a simple multiposition valve arrangement can switch from sample liquid flow to the mobile phase. Stopping the mobile phase flow in the SPME tube allows time for solute desorption to come to equilibrium between the SPME layer in the liquid mobile phase before the desorbed materials are introduced into the column. This somewhat cumbersome stop-flow operation may cause undue band broadening and encourages some to utilize an off-line desorption step.

In GC, desorption from fiber-based external SPME layers is more conveniently achieved by insertion into a standard GC capillary inlet system in much the same way as a syringe. Several trade-offs arise in the course of thermally desorbing an SPME layer for GC analysis. First, the desorption temperature must be high enough so that the solutes rapidly leave the SPME fiber. A desorption that is too slow may lead to peak broadening and tailing unless additional arrangements are made for trapping solutes at the beginning of the GC column before temperature-programmed elution. Conversely, too high of an inlet temperature may induce thermal decomposition and introduce some contaminants into the column from septum bleed, as well as from the SPME layer itself.

During sample desorption from an SPME fiber into a split/splitless inlet, the split flow should be turned off so that all of the solutes may enter the column without splitting, just as would occur in splitless injection. It is unlikely that enough sample mass will be absorbed on an SPME layer to necessitate sample splitting. A narrow-bore inlet liner (often called a "splitless" liner) helps produce better peak shapes as well, by limiting the volume into which the solutes may expand. After the SPME device has been withdrawn from an inlet splitter, the split flow may be turned back on to purge the inlet of any remaining materials and prevent some degree of peak tailing.

Programmed temperature vaporizer (PTV) inlet systems (see Chapter 6) are well-suited to SPME desorption because of their smaller internal volumes. For SPME use, they should be operated at the same elevated constant temperatures as conventional split/splitless inlets because PTV heat-up rates (on the order of several hundred degrees per minute) may not be fast enough to produce sufficiently narrow peaks without some form of additional stationary phase trapping.

## Pros and Cons of SPME

The primary advantages of SPME are its ability to decouple sampling from the matrix effects that would distort the apparent sample composition or disturb the chromatographic separation, its simplicity and ease of use, and its reduced or nonexistent solvent consumption. These characteristics combine to make SPME an attractive alternative to classical headspace or thermal desorption sampling, solid phase extraction, and classical liquid-liquid extraction.

As with a number of related sample preparation and injection techniques such as headspace GC or thermal desorption, SPME lends itself well to handling difficult sample matrices, but with the added benefit of low cost and simplicity. SPME does not require elaborate and expensive instrument accessories for occasional use and yet seems to be capable of delivering very good manual results in the hands of skilled users. This cannot necessarily be said for manual headspace or thermal desorption sampling. Autosamplers or robotics systems that perform repetitive unattended SPME sampling are also available; this automation availability is also a key advantage of SPME.

On the other hand, quantitation is a more difficult process in SPME. Standards must be prepared under the exact same conditions as samples, and that is not always possible. The fibers themselves are rather expensive and you need replacement on a relatively frequent basis. As the fiber ages, its behavior may change, resulting in a lower degree of reproducibility. The fibers are somewhat fragile, therefore method robustness is sometimes questioned. Relative to other sample preparation techniques, obtaining equilibrium conditions is quite slow, necessitating shorter sampling periods for practical requirements. As mentioned earlier, slow desorption times may necessitate trapping non-volatile solutes to refocus them for chromatographic analysis.

SPME requires careful optimization and consistent operating conditions for success, but this is true of related techniques as well. Any poorly characterized sampling technique has no valid use in the analytical laboratory, and the burden of developing an SPME method is no greater than for the other techniques. SPME has a significant place in the analyst's arsenal of sample preparation techniques.

## Example of SPME Sample Preparation

To illustrate the application of SPME, a method was developed to determine sub-ppb levels of phthalates in water by Auto-SPME and GC/MS<sup>23</sup>. Phthalic acid esters are key additives to many plastics to keep them pliable at room temperature. Due to their widespread use, relatively large amounts of these compounds are released into the environment. In recent years, considerable attention has been paid to human exposure to phthalates because of their suspected carcinogenic and estrogenic properties. Liquid-liquid extraction has been widely used to isolate phthalates from aqueous samples. SPME is an alternative approach to the analysis of phthalates in aqueous solutions. The extraction of analytes from aqueous samples can be performed by direct immersion of the fiber into the liquid phase or by headspace sampling. Here, the use of CombiPAL (Agilent Technologies) for the fully automated SPME sample preparation process is demonstrated. All movements of the SPME fiber are software-controlled for optimum precision and less operator attention. Since the phthalates are semi-volatile compounds, the immersion extraction mode was selected. First, the effect of extraction time versus amount extracted at a temperature of 40 °C was studied. **Figure 10.4** provides information on the amount extracted (signal response) versus extraction time for the six phthalates studied. As seen in the figure, when the extraction time was over 20 min, the responses changed only slightly, which meant that the extraction of most compounds reach equilibrium at this point. Thus, in this experiment, 20 min was selected as the extraction time.

It is generally known that the addition of salt to an aqueous solution improves the SPME extraction efficiency. Therefore, the salting out effect was studied by the addition of NaCl to the aqueous solution containing phthalates. Although not shown, the effect demonstrated that extraction efficiency improvements can be made by the salting out procedure. In the final experiments, a 20% (W/V) salt concentration was chosen. **Figure 10.5** shows the LC/MS SIM chromatogram of the phthalates at the optimized condition. The SPME method for sample preparation combined with GC/MS provided linearity over the range 1-1000 ng/mL with good correlation coefficients. The RSD's at a concentration of one ppb were less than 10%, except for DPP. Actual samples of tap water, potable water, and purified water from water dispenser were analyzed for the presence of phthalates. The results showed that phthalates were detected in all three samples at 24-79 ng/mL levels<sup>23</sup>.

Figure 10.4

### SPME Extraction Time Versus MS Response

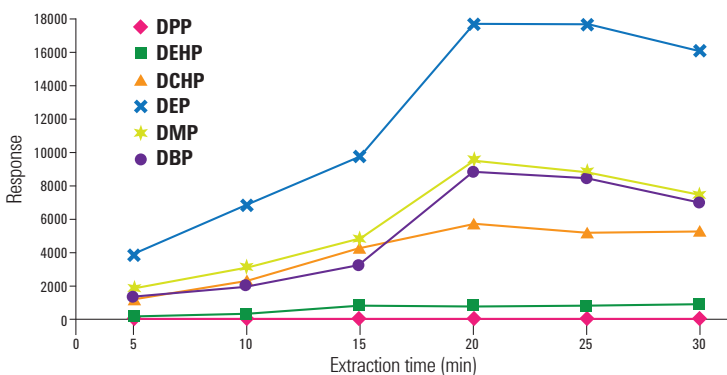

Compound Name	Abbreviation	Retention time (min)
Phthalic acid, bis-n-pentyl ester	DPP	10.179
Phthalic acid, bis-isononyl ester	DEHP	11.862
Di-cyclohexyl phthalate	DCHP	16.749
Diethyl phthalate	DEP	17.517
Dimethyl phthalate	DMP	20.666
Dibutyl phthalate	DBP	20.836

#### CombiPAL

Pre-incubation time: 60 s  
 Incubation temperature: 40 °C  
 Pre-inc. agitator speed: 500 rpm  
 Agitator on time: 5 s  
 Agitator off time: 2 s  
 Vial penetration: 25 mm  
 Extraction time: 1200 s  
 Desorb to: GC Inj 1  
 Injection penetration: 54 mm  
 Desorption time: 120 s  
 Post fiber condition time: 300 s

#### SPME

Fiber type: PDMS/DVB  
 Coating: 65 µm

Figure 10.5

### SIM Chromatogram of Phthalates at the Optimized Extraction Condition

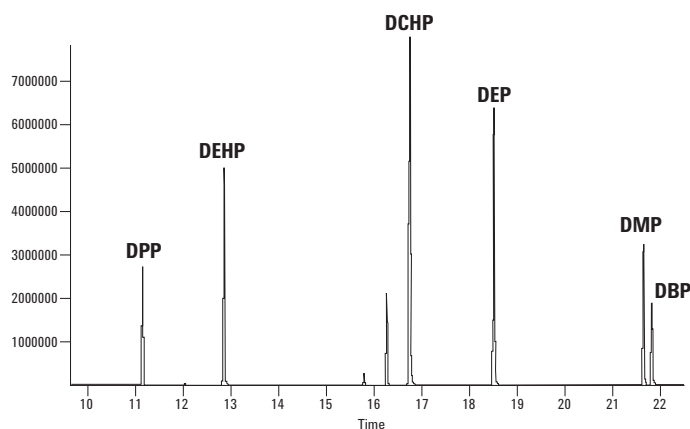

#### 6890 GC

Inlet temperature: 270 °C  
 Gas type: Helium  
 Oven condition: 50 °C ramps 10.00 °C/min to 260 °C (3.00 min)  
 Column: DB-5ms 30 m x 250 µm, 0.25 µm  
 Mode: Constant flow  
 Flow rate: 1.3 mL/min

#### 5975 MS

Acquisition mode: Synchronous SIM/scan  
 Mass range: 40-300  
 Sample: 3  
 Dwell time: 30 ms  
 MS source: 230 °C  
 MS quad: 150 °C

## Matrix Solid Phase Dispersion (MSPD)

Matrix Solid Phase Dispersion (MSPD) is a sample preparation technique for solid- (e.g. animal or plant tissue, milk, vegetables), semi-solid-, and viscous-samples<sup>24</sup>. It employs bonded phase solid supports, usually silica-based, as both an abrasive to produce a disruption of sample architecture and as a bound "solvent" to assist in complete sample disruption during the process of blending.

**Figure 10.6** provides a simplified description of the overall process. With this blending, the sample disperses itself over the surface of the bonded phase/support material providing a new mixed phase for conducting analyte isolation from a variety of sample matrices. The blending does not have to be performed with rigorous grinding by mortar and pestle, but gentle stirring is sufficient for most matrices. This dispersed sample provides more access to solvents and reagents used for analyte isolation. After the disruption process, the blended sample matrix and its distribution onto the bonded phase/support are transferred to a syringe barrel column fitted with a frit. A second frit is placed at the top of the packed bed. Various solvents, usually of progressively stronger polarity depending on the analytes to be eluted, are passed through the packed bed. Often, a second cleanup step is required. In some cases, the effluent from the MSPD column is directed to a conventional SPE cartridge where further purification takes place.

Figure 10.6

## Matrix Solid-Phase Dispersion Process

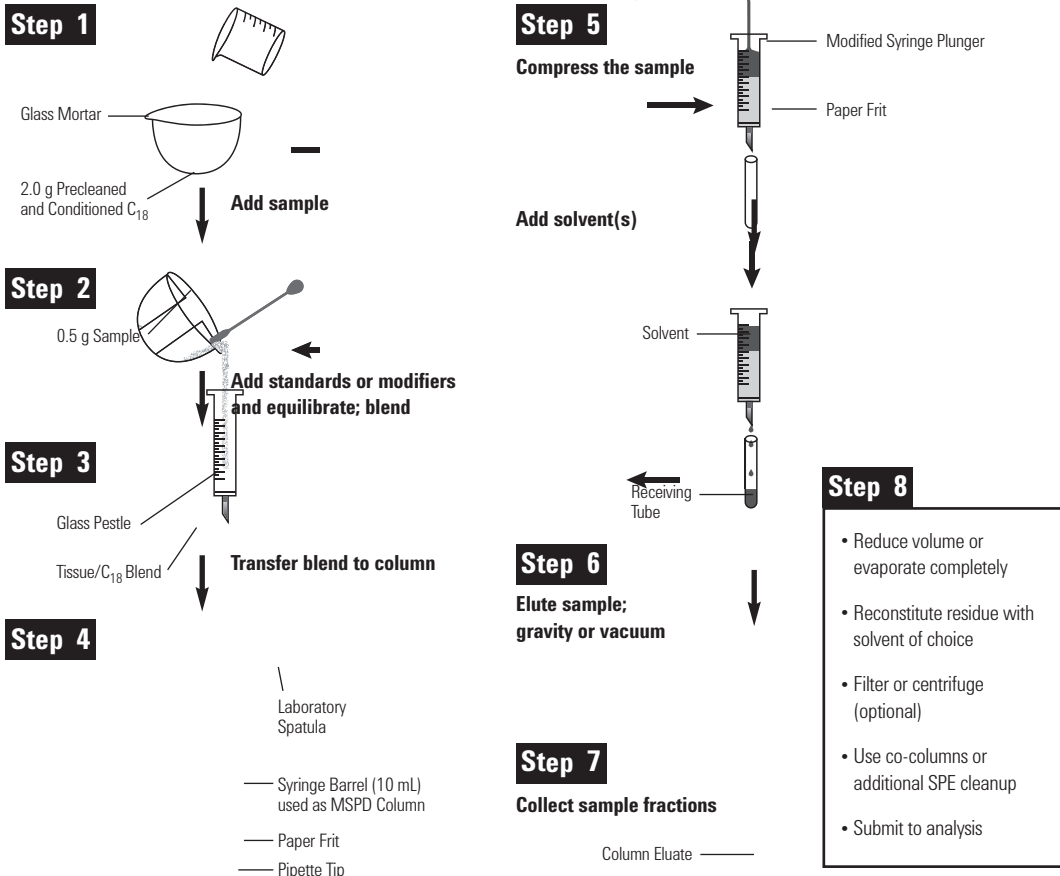

The MSPD technique has found widespread applications, especially in the food industry, such as for the sample preparation of pesticides in fruit<sup>25</sup>, baby food<sup>26</sup>, fruit juices<sup>27</sup>, veterinary drugs in tissue<sup>28</sup>, antibacterial residues in foodstuff<sup>29</sup>, isoflavones in clover leaves<sup>30</sup>, polyaromatic hydrocarbons in bivalves<sup>31</sup>, and antibiotics in milk<sup>32</sup>. The advantages of the method are its simplicity, good extraction efficiencies with reasonable recoveries, solvent savings over traditional extraction methods, and wide application range; however, automation of the technique is quite cumbersome.

# Specialty Phases in SPE

Specialty phases for SPE are phases that have been developed for specific applications that may be difficult to achieve on a standard SPE device. However, sometimes manufacturers will use a standard phase, but test it specifically for a certain class of compounds and provide a recommended set of SPE conditions for their optimum isolation. In some cases, the specialty SPE cartridges come as part of a “total solution” kit with reagents, standards, and a method. But most specialty SPE phases have been synthesized with chemical functionality that will specifically interact with solutes of interest. **Table 10.3** shows several specialty phases that are available to deal with specific cleanup tasks. Additional phases follow.

Table 10.3

Specialty Phases for SPE		
Bond Elut Name	Functional Group(s) Present	Main Application
Atrazine	C18	Low load, high-flow C18 phase designed for atrazine extraction. Large particle size allows flow of large sample volumes; Controlled carbon content enhances atrazine selectivity; Large bed mass offers optimized capacity for atrazine.
Carbon	Graphitized carbon	Non-porous sorbent exhibits high affinity for organic polar and non-polar compounds from both non-polar and polar matrices, when used in reversed-phase conditions; Recommended for removal of chlorophyll and other pigments (especially in QuEChERS applications, see Chapter 8).
Carbon/PSA	Graphitized carbon and primary secondary amine (layered)	Bond Elut PSA is an alkylated amine sorbent that contains two different amino functionalities: a primary and a secondary amine. This gives a slightly higher pKa and ionic capacity compared to Bond Elut NH <sub>2</sub> . The PSA sorbent has a significantly higher carbon load than most amino functional sorbents and therefore is a better choice for polar compounds that retain to strongly on Bond Elut NH <sub>2</sub> . Bond Elut PSA is an ideal sorbent removing fatty and organic acids as well as pigments and sugars when performing multiresidue pesticide food analysis.
Carbon/NH <sub>2</sub>	Graphitized carbon and amino (layered)	Designed for cleanup of Japanese Positive List for the analysis of pesticides in food; Bond Elut NH <sub>2</sub> , a primary amine, is a weaker anion exchanger, than sorbents such as SAX (a quaternary amine sorbent that is always charged). Therefore, it is a better choice for the retention of very strong anion such as sulfonic acids that retain irreversibly on an SAX sorbent. Bond Elut NH <sub>2</sub> is an ideal sorbent for removing fatty and organic acids, as well as pigments and sugars when performing multiresidue pesticide food analysis.

(Continued)

## Specialty Phases for SPE

Bond Elut Name	Functional Group(s) Present	Main Application
Cellulose	Cellulose powder	Cellulose phase stable over a wide pH range and contains an extremely low metal content (Fe and Cu content less than 5 ppm). The combination of surface area and polymeric structure results in a sorbent with excellent capacity. The cellulose media contains numerous hydroxyl groups; because of its polar nature, it is able to accept high loading of many polar substances from aqueous and organic phases.
EnvirElut	Polymeric	EnvirElut sorbents are specially designed for the extraction of a wide range of compounds from aqueous matrices, especially herbicides, Polynuclear aromatic hydrocarbons (PAHs), and pesticides.
Mycotoxin	Silica-based ion exchange	Novel sorbent which cleans up food extracts for improved trichothecene and zearalenon analysis. Results are comparable or superior to competing methods, including immunoaffinity columns (IAC) and charcoal/alumina column; acts in a selective non-retention mechanism – the toxin analytes pass through the cartridge while the food matrix components are retained (Explained more thoroughly later in this chapter, under <i>Class- or Ion-Specific SPE Cartridges, Mycotoxin SPE Sorbent</i> ).
PBA	Phenylboronic acid	Functionality that can retain analytes via a reversible covalent bond; boronate group has a strong affinity for cis-diol containing compounds such as catechols, nucleic acids, some proteins, carbohydrates and PEG compounds. Aminoalcohols, alpha-hydroxy amides, keto compounds, and others can also be retained; very strong covalent retention mechanism enables high specificity and cleanliness (Explained more thoroughly under <i>Immobilized Phenyl Boronic Acid (PBA) Phases</i> ).
PCB	Proprietary dual phase	Specially designed sorbent with optimized bed mass which allows for the facile extraction of polychlorinated biphenyl (PCB) compounds from a variety of matrices; desired analytes can be loaded and eluted using a simple, single solvent method prior to analysis by GC/ECD.



## Restricted Access Media (RAM)

The RAM is a special class of SPE sorbent used for the direct injection of biological fluids such as plasma, serum or blood. They are most often used for the analysis of small drugs, their impurities, and metabolites. Over the years, there have been many variations of these sorbents described as internal-surface reversed-phases, shielded hydrophobic phases, semi-permeable surfaces, dual-zone phases, and mixed functional phases. For more information on the various classifications of RAM, consult<sup>33,34</sup>.

The most popular RAM phases are the dual-mode porous packings that are characterized by an outer hydrophilic layer and an inner surface porosity with a hydrophobic bonded phase (**Figure 10.7**). The outer hydrophilic surface provides minimal interaction with proteins and when combined with small pores of the packing that exclude them, the proteins to elute unretained while small drugs and drug metabolites pass into the pores and are retained by hydrophobic interactions with alkyl bonded phases. Despite being described as “non-fouling” phases, RAMs have had a reputation for eventual fouling with repeated injections of straight biological fluids. If the pH and organic solvent composition of the mobile phase are not optimized, protein precipitation can occur in the RAM causing fouling, so some care must be exercised in their use.

Figure 10.7

### Pictorial Representation of Resticted Access Media (RAM)

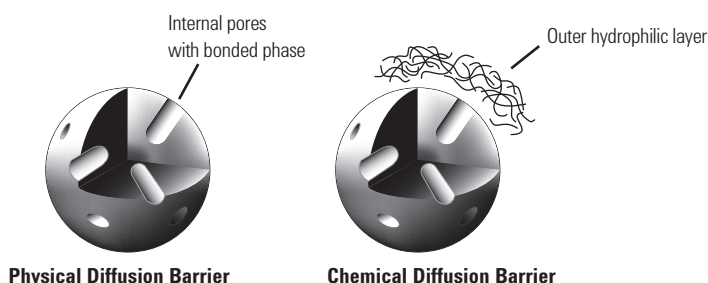

The RAM phases can be used in the single column mode or with multidimensional LC-LC. In the single column mode, conditions are selected to first exclude plasma proteins, then running gradient elution to elute and separate the drug compounds. Although this approach has worked satisfactorily, because of the increased chances of fouling the RAM due to lack of re-equilibration after gradient elution or due to inadequate selectivity of the hydrophobic stationary phase inside the pores, multidimensional LC-LC approaches have proven to be more successful. Here, an additional column (usually a reversed-phase column) is plumbed into the system after the RAM column via a 6- or 10-port switching valve (see Chapter 13 for more information on column configurations). Isocratic conditions are used for injection of the plasma onto the RAM, and an additional gradient pumping system is employed for the reversed-phase chromatographic analysis. In this approach, the trapped drug and its metabolite molecules from the RAM column can be flushed (or backflushed) into the reversed-phase column and gradient elution is performed to separate the impurities and/or metabolites. When these multidimensional approaches are employed, the RAM column is often backflushed and regenerated after each analysis. Longterm stability with repeated usage of the RAM column has been reported for soy isoflavones in rat serum<sup>36</sup>. In addition, the secondary reversed-phase column also has a longer lifetime since plasma proteins are not injected onto this second column but are vented to waste.

## Molecularly Imprinted Polymers (MIPs)

The MIPs are among the most selective phases used in SPE. The technique is sometimes referred to as molecularly imprinted solid-phase extraction (MIP-SPE). Molecular imprinting is a technique that has been used in areas where selective recognition is required for complex separations or sample cleanup. An introductory article<sup>37</sup> outlined the basics of MIP technology, while review articles<sup>38-41</sup>, and a book<sup>42</sup> provide detailed information on the use and potential of MIPs in SPE.

A MIP is a highly stable polymer that possesses recognition sites that are adapted to the three-dimensional shape and functionalities of an analyte of interest. The most common approach through the use of noncovalent imprinting involves the uses of a print molecule (template) that is chemically coupled with one of the building blocks of a polymer. After polymerization, the resulting bond must be cleaved to obtain a free selective binding site (receptor). The synthesis process is shown schematically in **Figure 10.8**.

The selective interactions between the template and the monomers are based upon hydrogen bonding, ionic and/or hydrophobic interactions. The most often used monomers are based on methacrylic acid and/or methacrylates. The basic idea of a MIP is the "lock and key" concept where a selective receptor or cavity on the surface of a polymer perfectly fits the template analyte that was used to prepare the MIP. The receptor site is complementary to the template in terms of its size, shape, and functionality. The concept is similar to immunoaffinity (IA) SPE phases (see next section, *Immunoaffinity Extraction of Small Molecules*) but obtaining and linking a suitable antibody for these IA sorbents can be very time consuming.

Figure 10.8

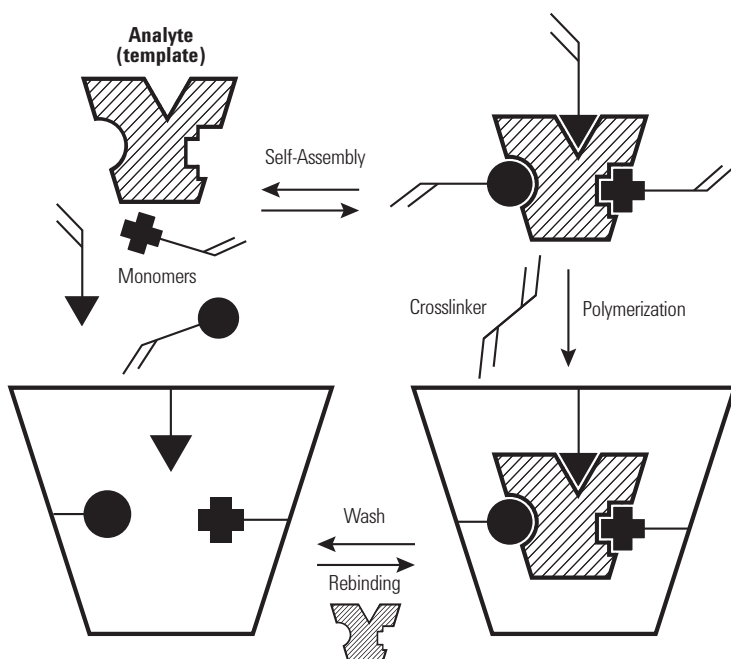

The removal of the template from the polymeric MIP is important, not only to make available the interaction sites for increased sample capacity, but to also ensure that the analyte to be isolated can be measured quantitatively. The lack of complete removal of the template molecules, even with exhaustive extraction, has been one of the main problems with the acceptance of MIPs. The template molecules frequently bleed, sometimes give baseline drifts, and they interfere with the quantitation of the desired analyte, especially at low levels. One approach to overcome this limitation is to use a template that is similar to the analyte of interest. An example would be to use a brominated analog template rather than a chlorinated molecule of interest. If the analog can be separated from the analyte of interest, then the MIP will function as desired.

With aqueous mobile phases, MIPs can display reversed-phase and ion exchange interaction since selective polar interactions are impaired. The MIP phases show the greatest selectivity when the experimental conditions are chosen that generate the selective interactions that are usually obtained in organic solvents used for the MIP synthesis. This approach allows the MIP to be used for trapping analytes from aqueous solution by hydrophobic or ionic interactions, then washed with a solvent that breaks selective binding of matrix components, and finally with an organic solvent which disrupts the strong bonds between the analyte and the MIP polymer matrix.

Since the SPE packing material is a polymer, depending on the degree of crosslinking, there may be some swelling or shrinkage with a change in solvent. Such a physical change can modify the size of the receptor and change the selectivity of the MIP for the target analyte. In this regard, perhaps the synthesis of molecular imprinted organic-inorganic hybrid polymers<sup>43</sup> may generate a more rigid substructure that does not swell and shrink.

A disadvantage of the MIP approach to SPE is the fact that each sorbent must be custom made. The specificity of the MIP can be determined by choosing the appropriate template molecule. The MIP can be synthesized in the laboratory using published procedures, or the template molecule can be sent to a specialty laboratory that will make a custom MIP. Because of the relatively long process involved in making a MIP for SPE, one can justify it only if the application will frequently be required, or if there is no other way to perform sample cleanup.

Recently, off-the-shelf MIPs have been introduced. These standard MIP phases have been designed for specific analytes that are popularly encountered in complex matrices. Among those currently available are sorbents optimized for:

- Clenbuterol in biological fluids
- Beta agonists, multiresidue extractions in urine and tissue samples
- NNAL (4-Methylnitrosamino-1-(3-pyridyl)-1-butanol), tobacco-specific nitrosamine in biological matrices
- Riboflavin (vitamin B2) in aqueous samples
- Triazines, multiresidue extraction in water, soil, and food products
- Chloramphenicol, antibiotic in biological matrices
- Beta blockers, multiresidue extractions in water, and biological samples

## Immunoaffinity Extraction of Small Molecules

Similar to MIPs, immunoaffinity phases are based upon molecular recognition but use chemically attached mono- or poly-clonal antibodies rather than surface cavities. Undoubtedly, the immunoaffinity phases are the most selective since they are primarily designed around biological antigen-antibody interactions that provide high selectivity and high affinity. These sorbents enable the selective extraction and concentration of individual compounds or classes of compounds from matrices, often in a single step.

Antibodies for large biomolecules are readily available and have been used for many years in immunology and medical research and in the immunoextraction of enzymes, hormones, and other biospecies (see Chapter 15 for an example of immunoextraction of proteins). However, antibodies for small molecules are more difficult to obtain, so the development of small molecule immunoaffinity extraction is more recent and less developed. Some excellent review articles are available for those who would like to understand immunoaffinity extractions in more detail<sup>44-48</sup>.

To demonstrate the use of immunoaffinity sample preparation, a sample cleanup of corn and peanut butter samples was performed for the analysis of aflatoxins using an AflaPrep immunoaffinity SPE cartridge (R-Biopharm, Darmstadt, Germany). The cartridge contains an anti-aflatoxin antibodies immobilized on a wide-pore silica and is selective for the compound class. Aflatoxins are highly toxic natural substances and suspected carcinogens produced by mold that can be found on agricultural products such as grains, corn, peanuts, and seeds. There are four fluorescent aflatoxins that are commonly analyzed: B1, B2, G1, and G2, each with different structures. The common analysis procedure is to perform liquid-liquid extraction, SPE or column chromatography, followed by HPLC analysis with fluorescence detection.

Recently, a more selective, straightforward cleanup was introduced using off-line immunoaffinity chromatography<sup>50</sup>. **Figure 10.9** depicts results obtained by immunoaffinity cleanup followed by reversed-phase chromatography and fluorescence detection using post-column electrochemical derivatization using bromine as a derivatizing agent. The linear range for each of the four aflatoxins was found to be 0.1-10 µg/L with the R-square value greater than 0.99998. Limits of detection were found to be in the range of 0.004-0.007 µg/L (equivalent to 0.008-0.014 µg/kg content in the samples). Relative standard deviations of retention time and peak areas for all four aflatoxins were all less than 0.3%.

Figure 10.9

## Determination of Aflatoxins in Corn and Peanut Butter

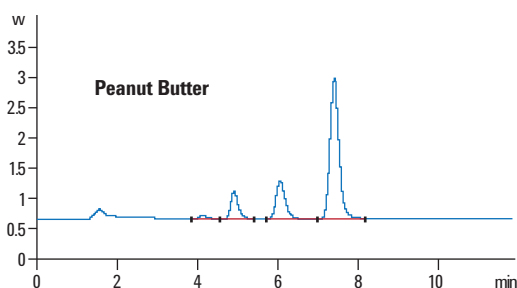
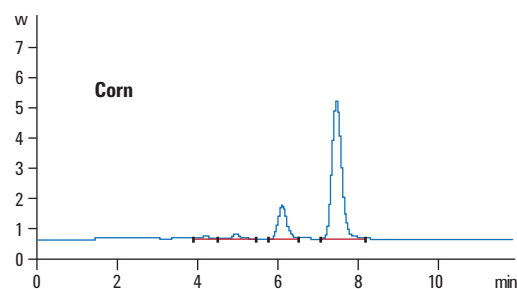
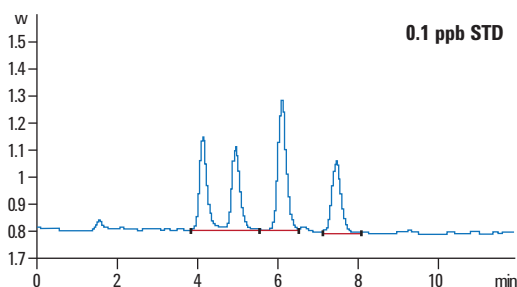

### HPLC Conditions

Column: Zorbax Eclipse Plus C18,  
4.6 x 150 mm x 5  $\mu$ m

Column Temp.: 40 °C

Mobile Phase A: 1 L water containing 238 mg KBr  
and 700  $\mu$ L 4M HNO<sub>3</sub>

Mobile Phase B: MeOH

Isocratic: A: B = 50; 50, 12 min

Flow rate: 1.0 mL/min

Detection: Ex: 362 nm, Em: 455 nm, gain = 15

Injection: 20  $\mu$ L

Electrochemical  
Current: 100  $\mu$ A setting

Reaction coil: 0.5 mm id 34 cm long peek tubing (from exit  
of KOBRA cell to the entrance of FLD)

The sample preparation procedure for the aflatoxins involved weighing a 25 g sample, adding 2 g NaCl and 125 mL HPLC grade methanol-distilled water (60:40 v/v) into a high-speed blender jar. Blend for one minute and dilute the extract with 125 mL of distilled water. After filtration, 10 mL of the filtrate was passed through the immunoaffinity column at a flow rate of 2-3 mL/min. The column was washed with 10 mL of water. Finally, the aflatoxins were eluted from the cartridge using 1 mL of HPLC-grade methanol. The methanol extract was diluted with 1 mL of water before injection into the HPLC.

## Class- or Ion-Specific SPE Cartridges

Over the years, specialty phases have been introduced that are compound-, class- or element-specific. Of course, the immunoaffinity- and MIP-SPE phases are on the extreme ends of the selectivity scale. Specialty phases have special functional groups that can interact with certain compounds and have found use in niche applications.

### Immobilized Phenylboronic Acid (PBA) Phases

When the PBA-SPE phases are treated with alkaline buffer, they become very specific for certain functional groups such as vicinols which are present in sugars and catechols. Other difunctionalities can also be reactive. For example, alpha-hydroxy acids, aromatic o-hydroxy acids and amides, and aminoalcohol-containing compounds can be retained. They actually form covalent bonds with these groups (see details in **Figure 10.10**). When bonded, the sorbents can be washed with any number of solvents to remove interferences. Once washed, the covalent bonds can be broken by washing the phase with an acidic buffer/solvent that hydrolyzes the covalent bonds. A popular application of the PBA phases is the isolation of catecholamines in biological fluids<sup>52</sup>.

Figure 10.10

#### Anticipated Secondary Interactions Exhibited by Immobilized PBA

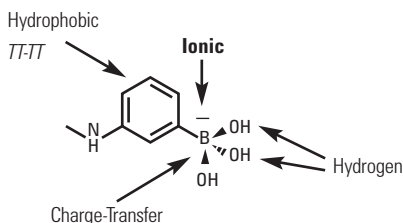

An application displaying the unique selectivity of the PBA phase is the determination of Ribavirin in human plasma<sup>53</sup>. Ribavirin is in a class of antiviral medications called nucleoside analogues. It works by stopping the virus that causes hepatitis C from spreading inside the body. The chemical structure (**Figure 10.11**) shows a distinctive diol group that is well-suited for the PBA's ability to covalent bond as indicated in **Figure 10.10**.

The sample preparation procedure was simple. The heat-deactivated plasma was mixed with ammonium acetate buffer (250 mM, pH 8.5) and loaded onto a Bond Elut PBA cartridge (100 mg/1 mL), first conditioned with MeOH, followed by 2 mL of ammonium acetate buffer. After loading, the cartridge was washed with the same buffer followed by MeOH. Finally, the analytes were successively eluted with 1 mL of 2.5% formic acid in methanol. After evaporating the eluent to dryness, the dried extracts were reconstituted with 200  $\mu$ L of mobile phase, centrifuged, and a portion injected into a reversed-phase column with UV detection. The PBA method gave better recovery and reproducibility than did LLE with various solvent combinations. The calibration curve was linear over the range of 0.05-10  $\mu$ g/mL and the limit of quantitation (LOQ) was determined to be 0.050  $\mu$ g/mL. This extraction method can also be modified to facilitate the extraction of ribavirin from foods such as chicken<sup>54</sup>.

Figure 10.11

### Structure of Ribavirin

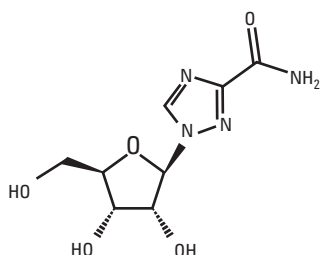

### Drugs of Abuse Analysis

Screening for drugs of abuse in biological fluids is an important application of SPE. In this particular analysis, high purity, high recovery, and rugged methods are essential for an effective screen and to avoid false positives. The Certify (Agilent Technologies) mixed mode SPE sorbent takes advantage of non-polar, polar, and ion exchange properties. Because the sorbent is capable of exhibiting a variety of sorbent-analyte interactions, they can be used either as a general screen for several broad drug classes or in specific extractions for GC and GC/MS confirmation of drugs and metabolites. The use of a bonded phase containing a medium length hydrocarbon chain (C8) allows for some exposure of the polar silica surface. Therefore, polar and non-polar interactions of the drugs and matrix interferences with the sorbent are optimized. The second bonded phase, a strong cation exchanger, has been optimized for capacity.

The Certify cartridge is conditioned first with methanol to open up the coiled hydrophobic portion of the sorbent and activate it toward interaction with polar matrix. Further conditioning with buffer removes excess methanol and places the sorbent bed in an environment as similar to the matrix as possible. This allows for maximum sorbent-matrix interaction and reproducible recoveries. The extraction of drugs from complex biological matrix such as plasma or urine requires that pH, ionic strength, and viscosity be controlled. This is accomplished by dilution of the sample with buffer.

Certify is recommended for the cleanup of basic drugs such as amphetamines, phencyclidine, proxyphene, meperidine, LSD, codeine, oxycodone, and opiates. Although very different in their pharmacology and structure, all basic drugs feature amine functional groups ( $\text{NR}_3$ ,  $\text{NR}_2\text{H}$ , or  $\text{NRH}_2$ ). This group acts as a base by abstracting  $\text{H}^+$  and becoming positively charged. Initial extraction, however, takes place by non-polar mechanism onto the hydrophobic portion of the sorbent. After the drug is retained, washing the cartridge with water removes polar interferences. Next, the cartridge is washed with acid, completing the elution of polar interferences and ensuring that the basic drugs of positively charged as ammonium salts. Non-polar, non-basic drugs and interferences can then be removed with an organic wash. Finally, the basic drugs can be eluted with alkaline organic solvent [i.e. 2%  $\text{NH}_4\text{OH}$  in either methanol, ethyl acetate (EtOAc), or  $\text{CH}_2\text{Cl}_2$ /isopropanol (IPA)]. The presence of base serves to disrupt the ionic interactions of the drug with the sorbent since the positive charge on the drug is neutralized. The use of organic solvent disrupts the hydrophobic interactions, which initially retained the drug from the sample.

Similar to the basic drugs, acidic and neutral drugs, such as barbiturates, phenytoin, methaqualone, benzodiazepines, and  $\Delta^9$ -carboxy THC, have widely varying pharmacological and structural properties. They are classed together because they are not retained by a cation exchange mechanism, although the cation exchange portion of Certify can improve cleanup of samples containing these drugs. These drugs are characterized by the absence of a basic amine functional group. (Note, drugs such as barbiturates have a nitrogen-containing imine functional group, which is weakly acidic, rather than basic). These drugs are retained by a non-polar mechanism. Washing the cartridge with dilute acid removes polar impurities and insures that any basic interferences become charged. Thus, when the acidic and neutral drugs are eluted by disrupting their non-polar interaction with the sorbent, the basic interferences are retained on the strong cation exchange portion of the sorbent. To handle these acidic and neutral drugs, Certify II was developed. It is a mixed mode sorbent with a short chain alkyl group (C8) along with anion exchange functionality. Retention of the acidic drugs on Certify II is initially achieved by non-polar interactions on the hydrophobic portion of the sorbent. Next, polar interferences can be washed away with the basic buffer. This wash step also ensures that the  $\text{COOH}$  functional group is deprotonated, forming  $\text{COO}^-$ , which can then be retained on the anion exchange portion of the Certify II sorbent. The charge on any amine functional groups would be neutralized by this step as well, preparing any basic drugs present for the washing step. After briefly drying the cartridge, non-polar basic drugs and interferences can be removed with a non-polar solvent. Finally, acidic drugs such as  $\Delta^9$ -carboxy THC can be recovered by elution with a non-polar acidic solvent such as hexane/EtOAc with 1% acetic acid.

To illustrate how the Certify drugs of abuse phases are used in practice, we will look at cleanup of THC and its metabolites in whole blood<sup>55</sup>. The traditional analytical technique for screening drugs of abuse is GC followed by GC/MS for confirmation. The key to reliable THC testing in blood is to have an efficient extraction method. In this example, SPE using Certify II was employed for cleanup followed by GC-MS/MS for analysis. Only 2 mL of blood sample was required for the assay. Deuterated internal standards of tetrahydrocannabinol (THC) and its known metabolites 11-hydroxy- $\Delta$ -tetrahydrocannabinol (11-OH-THC) and 11-nor- $\Delta$ -9-tetrahydrocannabinol-9-carboxylic acid (THCA) were spiked in the blood sample at the 10  $\mu\text{g}/\text{mL}$  level. Next, 4 mL of acetonitrile was added to precipitate the plasma proteins. After centrifugation, the supernatant was transferred and evaporated to about 3 mL followed by the addition of 7 mL of 0.1 M sodium acetate (pH 6.0).



High Flow Bond Elut Certify II cartridges were conditioned with 2 mL of methanol, then 2 mL of 0.1 M sodium acetate buffer (pH 6.0) with 5% methanol. The sample was slowly added to the cartridge. The cartridge was then washed with 2 mL of sodium acetate buffer, dried under vacuum for 5 min and washed with 1 mL hexane. The THC was eluted under neutral conditions with 2 mL of 95:5 hexane:ethyl acetate. This was followed by 5 mL 1:1 methanol:deionized water wash. Again, the column dried under vacuum for 5 min and washed again with 1 mL hexane elution of the metabolites was performed with 2 mL of 1% acetic acid in 75:25 hexane:ethyl acetate. The THC and metabolites fractions were combined, evaporated to dryness, and reconstituted with toluene before derivatization. The 3 analytes were derivatized with 40  $\mu$ L of N,O-Bis(trimethylsilyl)trifluoroacetamide (BSTFA) and 1% trimethylchlorosilane (TMCS).

Gas chromatography analysis was performed using an Agilent Triple Quadruple GC/MS equipped with a low thermal mass (LTM) column module which allows very fast temperature ramping and rapid cooling. In addition, the backflushing feature of the gas chromatograph was used to prevent any carryover of impurities that may have been co-extracted with the analytes of interest. Details of the chromatographic and mass spectrometric conditions can be found in the original application note<sup>55</sup>. Using SPE cleanup, GC column backflushing, and MRM for the triple quadrupole mass spectrometer, signals for the various analytes were very clean and allowed the detection of very low levels of THC and its metabolites. The resulting linear dynamic range of quantification was 0.1-50 ng/mL for THC and 11-OH-THC and 1-100 ng/mL for THCA. The LTM module and backflushing facilitated rapid analysis with a run time of 6 minutes and a cycle time of 8 minutes. An alternative analytical technique for THC analysis that avoids having to perform derivatization as is required for GC is the use of LC-MS/MS<sup>56</sup>.

## Ion Removal by SPE

In many applications, especially in ion chromatography, high concentrations of ionic components from the sample matrix can be undesirable interferences. The use of ion exchange resins with specific functionalities can be used to remove these ionic species. For example, a strong cation exchanger in the barium form will selectively remove high concentrations of sulfate from aqueous solution. The same can be said for a cation ion exchanger in the silver form for the removal of chloride ion. Chelating ion exchangers can remove transition metals.

## Mycotoxin SPE Sorbent

Fusarium fungi are probably the most prevalent toxin producing fungi of the northern temperate regions and are commonly found in cereals grown in the temperate regions of America, Europe, and Asia. A variety of Fusarium fungi produce different toxins of the class of trichothecenes. These toxins are very detrimental to human health. Twelve type A- and B- trichothecenes and zearalenone (ZEA) in cereals and cereal-based food can be isolated using Bond Elut Mycotoxin, a specialty SPE phase for these important compounds<sup>57</sup>. First, the toxins are extracted from the finely-ground cereal samples using acetonitrile/water (80:20 v/v), which minimizes co-extractables from the matrix. After filtration, a 4 mL portion of the filtrate is passed through a Bond Elut Mycotoxin SPE column and the effluent is collected and evaporated to dryness under a gentle stream of nitrogen. The sample was reconstituted in 0.5 mL of acetonitrile:water (20/80 v/v) and a 10  $\mu$ L portion is injected into the LC-MS/MS for analysis. A wide number of grains ranging from corn, wheat, oats, bread, etc. were spiked with the 12 trichothecenes and ZEA and recoveries at the part per billion level were quite acceptable, averaging from 70-95% with RSDs averaging around 5%. Recoveries were better than the conventional cleanup via charcoal-alumina columns and compared to immunoaffinity columns that were considerably more expensive since multiple columns were required. An advantage is that the Bond Elut Mycotoxin SPE cartridge allows the isolation of multiple mycotoxins such as aflatoxins, ochratoxin, fumonisins, and others<sup>58</sup>.

## Multimodal and Mixed-Phase Extractions

Most SPE procedures involve the use of a single separation mode (e.g., reversed-phase) and a single SPE device (e.g., cartridge). However, when more than one type of analyte is of interest, or if additional selectivity is required for the removal of interferences, multimodal SPE can prove useful. Multimodal SPE refers to the intentional use of two (or more) sequential separation modes or cartridges (e.g., reversed-phase and ion exchange). Experimentally, there are two approaches to multimodal SPE. In the serial approach, two (or more) SPE cartridges are connected in series (see **Figure 10.12**). Thus, for the separate isolation of acids, strong bases, and neutrals, an anion- and cation exchange cartridge could be connected in series. By adjusting the sample and wash solvent to pH 7, both the acids and bases will be fully ionized. As a result, the acids will be retained on the anion exchange cartridge, the bases will be retained on the cation exchange column, and the neutrals will pass through both columns (separated from acids and bases). The acids and bases can then be separately collected from each cartridge.

A second approach to multimodal SPE uses mixed phases. Here, a single cartridge phase might possess two (or more) functional groups to retain multiple species, or to provide a unique selectivity. Often, a single phase can show multiple interactions. For example, a polymeric ion exchange phase could show ionic interactions (e.g. cationic or anionic) and hydrophobic interactions with the polymer backbone (e.g. PS-DVB). One popular application of multimodal SPE is the isolation of drugs of abuse and pharmaceuticals from biological fluids as mentioned above.

Another version of multimodal SPE is the use of layered packings<sup>59</sup> where two or more packings in a single cartridge are used to isolate differing molecular species. Several methods for pesticides in vegetables rely on layered phases to provide the needed selectivity for adequate sample cleanup. The most popular method employing layers of SPE phases is the Japan Positive List for agricultural chemicals in foods<sup>60</sup>. Many countries that export agricultural products to Japan must test according to this list, which consists of the total 799 compounds. This list not only includes pesticides, but also feed additives in veterinary drugs. For analysis, most of these methods require LC/MS (or MS/MS) or GC/MS using reversed-phase HPLC columns. Two detailed multiresidue screening methods using graphitized carbon/amino layered SPE phases and silica phases for sample cleanup are available for pesticides in tomato and lemon matrices<sup>61</sup>.

Figure 10.12

### Experimental Setup for Multimodal SPE for Cleanup of Complex Samples

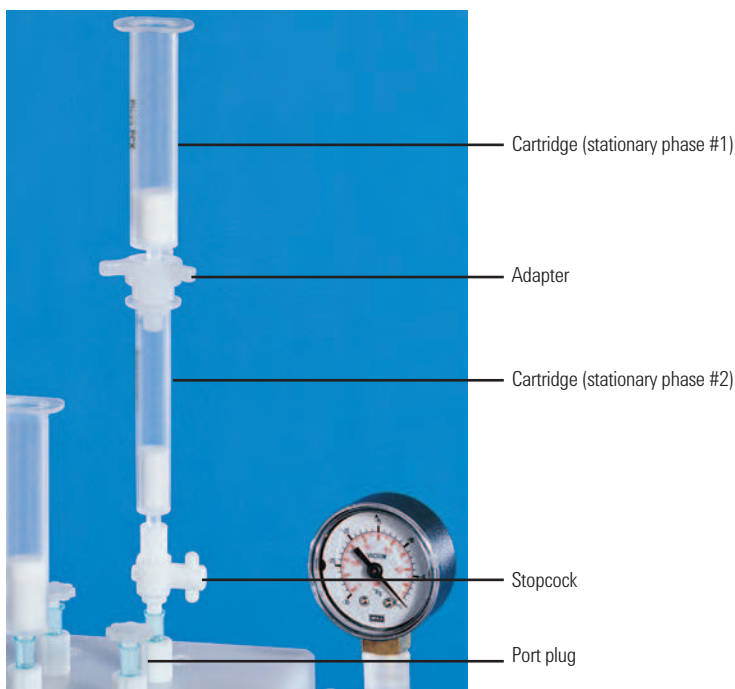

## References

---

1. Arthur, C.L.; Pawliszyn, J. *Anal. Chem.* **1990**, *66*, 2145-2148.
2. Baltrussen, E.; Sandra, P.; David, F.; Cramers, C.A. *J. Microcol. Sep.* **11**, **1999**, 737.
3. Battik, P.; Vednar, P.; Cip, L.; Ondrakova, L.; Stransky, Z. *JSS* **2003**, *26* (8), 715-721.
4. Hook, G.L.; Kimm, G.; Betsinger, G.; Savage, P.B.; Swift, A.; Logan, I.; Smith, P.A. *JSS* **2003**, *26* (12-13), 1091-1096.
5. Frost, R.P.; Hussain, M.S.; Raghani, A.R.; *JSS* **2003**, *26* (12-13), 1097-1103.
6. Cai, L.; Xing, J.; Dong, L.; Wu, C. *J. Chromatogr. A* **2003**, *1015* (1-2), 11-21.
7. Araujo, W.A.; Lacerda, C.A.; Cappelaro, E.A.; Lancas, F.M. *JSS* **2003**, *26* (6/7), 624-628.
8. Pinho, O.; Peres, C.; Ferreira, I.M.P.L.V.O. *J. Chromatogr. A* **2003**, *1015* (1-2), 23-30.
9. Castro Mejias, R.; Natera Marn, R.; de Valme Garca Moreno, M.A.; Garca Barroso, C. *J. Chromatogr. A* **2003**, 995 (1-2), 11-20.
10. Bagheri, H.; Mohammadi, A. *J. Chromatogr. A* **2003**, *1011* (1-2), 1-9.
11. Bianchi, F.; Caren, M.; Mangia, A.; Musci, M. *JSS* **2003**, *26* (5), 369-375.
12. Namiesnik, J.; Jastrzebska, A.; Zygmunt, B. *J. Chromatogr. A* **2003**, *1016* (1), 1-9.
13. Lin, H.-H.; Sung, Y.-H.; Huang, S.-D. *J. Chromatogr. A* **2003**, *1012* (1), 57-66.
14. Liu, W. *Determination of Sub-ppb Level of Phthalates in Water by Auto-SPME and GC/MS*, Agilent Technologies Application Note #5989-7726EN, **January, 2008**.
15. Centineo, G.; Ignacio Alonso, J. *Speciated Isotope Dilution for Determination of Methyl Mercury in Tuna Fish by GC/MS*, Agilent Technologies Application Note #5989-9725EN, Santa Clara, CA, **September 2008**.
16. Zhao, S.; Zhai, A. *Determination of Volatile Aromatic Compounds in Soil by Manual SPME and Agilent 5975T LTM GC/MSD*, Agilent Technologies Application Note #5990-6398EN, Santa Clara, CA, **October, 2010**.
17. Baumann, S. *Sensitive Detection of 2-Methoxy-3-Isobutylpyrazine (MIBP or IBMP) in Wine Using Triple Quadrupole GC/MS in PCI Mode*, Agilent Technologies Application Note #5990-4935EN, Santa Clara, CA, **November, 2009**.
18. Shutao, W.; Yan, W.; Hong, Y.; Zie, Y. *Chromatographia* **2006**, *63*, 365-371.
19. You, Y.-W. *Sensitive Detection of 2-MIB and Geosmin in Drinking Water*, Agilent Technologies Application Note #5991-1031EN, Santa Clara, CA, **August, 2010**.
20. Baumann, S.; Tandon, K. *Sensitive Detection of Trichloroanisole (TCA) in Wine Using Triple Quadrupole GC/MS*, Agilent Technologies Application Note #5990-4968EN, Santa Clara, CA, **November, 2009**.
21. Hinshaw, J. Solid-Phase Microextraction, *LCGC No. Amer.* **2012**, *30* (10), 904-910.
22. Eisert, R.; Pawliszyn, J. *Anal. Chem.* **1997**, *69*, 3140-3147.
23. Liu, W. *Determination of Sub-ppb Level of Phthalates in Water by Auto-SPME and GC/MS*, Agilent Technologies Application Note #5989-7726EN, **2008**.
24. Barker, S.A.; Long, A.R.; Short, C.R. *J. Chromatogr.* **1989**, *475*, 353-361.
25. Ramos, J.J.; Gonzalez, M.J.; Ramos, L. *J. Chromatogr. A* **2009**, *1216* (43), 7307-7313.
26. Georgakopoulos, P.; Mylona, A.; Athanasopoulos, P.; Drosinos, E.H.; Skandamis, P.N. *Food Chem.* **2009**, *115* (3), 1164-1169.
27. Radisic, M.; Grujic, S.; Vasiljevic, T.; Lausevic, M. *Food Chem.* **2009**, *113* (5), 712-719.
28. Wang, S.; Mu, H.; Bai, Y.; Zhang, Y.; Liu, H. *J. Chromatogr. B* **2009**, *877* (27), 2961-2966.
29. Marazuela, M.D.; Bogialli, S. *Anal. Chim. Acta* **2009**, *645* (1-2), 5-17.
30. Visnevschi-Necrasov, T.; Cunha, S.C.; Nunes, E.; Oliveira, M.B.P.P. *J. Chromatogr. A* **2009**, *1216* (18), 3720-3724.

## References

31. Campins-Falco, P.; Verdu-Andres, J.; Sevillano-Cabeza, A.; Molins-Legua, C.; Herraiez-Hernandez, R. *J. Chromatogr. A* **2008**, *1211* (1-2), 13-21.
32. Mamani, M.C.V.; Reyes, F.G.R.; Rath, S. *Food Chem.* **2009**, *117* (3), 545-552.
33. Boos, K.-S.; Rudolphi, A. *LCGC* **1997**, *15* (7), 602-611.
34. Boos, K.-S.; Rudolphi, A. *LCGC* **1997**, *15* (9), 814-823.
35. Cassiano, N.M.; Lima, V.V.; Oliveira, R.V.; de Pietra, A.C.; Cass, O.B. *Anal. Bioanal. Chem.* **2006**, *384* (7-8), 1462-1469.
36. Doerge, D.R.; Churchwell, M.L.; Berry Delclos, K. *Rapid Commun. in Mass Spectrometry*, **2000**, *14*, 673-678.
37. Ensing, K.; Berggren, C.; Majors, R.E. *LCGC* **2001**, *19* (9), 942-954.
38. Dmitrienko, S.G.; Irkha, V.V.; Kuznetsova, A. Yu.; Zolotov, Yu. A. *J. Anal. Chem.* **2005**, *59* (9), 808-817.
39. Baggiani, C.; Anfossi, L.; Giovannoli, C. *Current Pharma. Anal.* **2006**, *2* (3), 219-247.
40. Mahony, J.O.; Nolan, K.; Smyth, M.R.; Mizaikoff, B. *Anal. Chim. Acta* **2005**, *534*, 31-39.
41. Cormack, P.A.G.; Elorza, A.Z. *J. Chromatogr. B* **2004**, *804*, 173-182.
42. Piletsky, S.; Turner, A. *Molecular Imprinting of Polymers*, Landes Bioscience, Austin, TX, **2006**.
43. Lin, C.I.; Joseph, A.K.; Chang, C.K.; Wang, Y.C.; Lee, Y.D. *Anal. Chim. Acta* **2003**, *481*, 175-180.
44. Hennion, M.-C.; Pichon, V. *J. Chromatogr. A* **2003**, *1000*, 29-52.
45. Pichon, V.; Delaunay-Bertoncini, N.; Hennion, M.-C. *Chapter 33 – Immunosorbents in Sample Preparation, in J. Pawliszyn, Comprehensive Analytical Chemistry* **2002**, *37*, 1081-1100.
46. Delaunay, N.; Pichon, V.; Hennion, M.-C. *J. Chromatogr. B* **2000**, *745*, 15.
47. Stevenson, D. *J. Chromatogr. B* **2000**, *745*, 39.
48. Delaunay-Bertoncini, N.; Pichon, V.; Hennion, M.-C.; *Chromatographia* **2001**, *53*, S224.
49. Majors, R.E. *LCGC No. Amer.* **2007**, *25* (1), 16-32.
50. Yang, X.; Rong, A. *Determination of Aflatoxins (B1, B2, G1 and G2) in Corn and Peanut Butter by HPLC-FLD Using Precolumn Immunoaffinity Cleanup and Post-Column Electrochemical Derivatization*, Agilent Technologies Application Note #5990-9125EN, Shanghai, China, **2011**.
51. Li, X.; Pennington, J.; Stobaugh, J.F.; Schöneich, C. *Analytical Biochemistry* **2008**, *372* (2), 227-236.
52. *Phenylboronic Acid (PBA) Solid-Phase Extraction Mechanisms and Applications*, Agilent Technologies Technical Overview, Publication #Si-02442, **2010**.
53. Loregian, A.; Scarpa, M.C.; Pagni, S.; Giuseppe-Parisi, S.; Palu, G. *J. Chromatogr. B* **2007**, *856* (1-2), 358-364.
54. Berendsen, B.J.A.; Wegh, R.S.; Essers, M.L.; Stolker, A.A.M.; Weigel, S. *Anal. Bioanal. Chem.* **2012**, *402* (4), 1611-1623.
55. Baumann, S. *Rapid and Robust Detection of THC and Its Metabolites in Blood*, Agilent Technologies Application Note #5990-8456EN, **2011**.
56. Hudson, J.; Hutchings, J.; Wagner, R.; Harper, C.; Friel, P. *Cannabinoid Quantitation Using an Agilent 6430 LC/MS/MS*, Agilent Technologies Publication Number 5991-2521EN, **2013**.
57. Rudrabhatla, M.; Wood, J.S. *Amer. Lab.* **April 1, 2007**, 40.
58. Raisglid, M.; Burke, M.F. *Abstract #653*, 48th Pittsburgh Conference on Analytical Chemistry and Applied Spectroscopy, Atlanta, GA, **1997**.
59. *Introduction of the Positive List System for Agricultural Chemical Residues in Foods*, Japanese Department of Food Safety, Ministry of Health, Labour and Welfare, **June 2006**.
60. Chang, E.; Yamashita, K.; Simpson, N.; Arora, R. *Multiresidue Screening of Agricultural Chemicals (I) and (II) in Food According to the Japan Positive List using Agilent Cartridge-Based SPE and LC-MS/MS*, Agilent Technologies Application Note #5990-9895EN, **2012**.

# Size-Exclusion Chromatography as a Sample Preparation Technique

Size-exclusion chromatography (SEC) is one of the main modes of HPLC. Unlike other HPLC modes, in SEC there is no interaction between the analyte and the stationary phase. Molecules are separated on the basis of size in solution. Packing materials with various size pores are used for separations. As shown in **Figure 11.1**, large molecules are excluded from these solvent-filled pores while small molecules permeate the pores and elute later. Thus, if one is interested in lower molecular weight analytes in the presence of higher molecular weight species, SEC is an ideal sample preparation technique. If the high molecular weight molecules are not of interest they can be directed to waste via a column switching valve (see Chapter 13), while the small molecules can be directed to a second HPLC column for further separation and characterization. The technique can also be performed off-line, by collecting the fractions of interest and re-injecting them into another column. Both non-aqueous and aqueous size-exclusion chromatography can be performed in this manner. Calibration curves for SEC columns of molecular weight (size) versus elution volume are useful to provide guidelines for choosing the best sample cleanup column (see later discussion).

Figure 11.1

## Mechanism of SEC

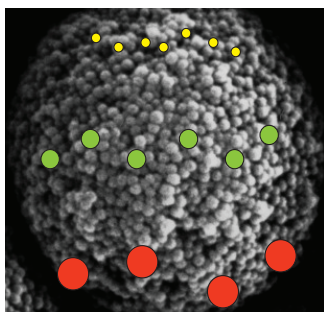

Molecules must freely enter and exit pores to be separated. Largest molecules elute first, followed by intermediate size molecules, and finally the smallest molecules elute last.

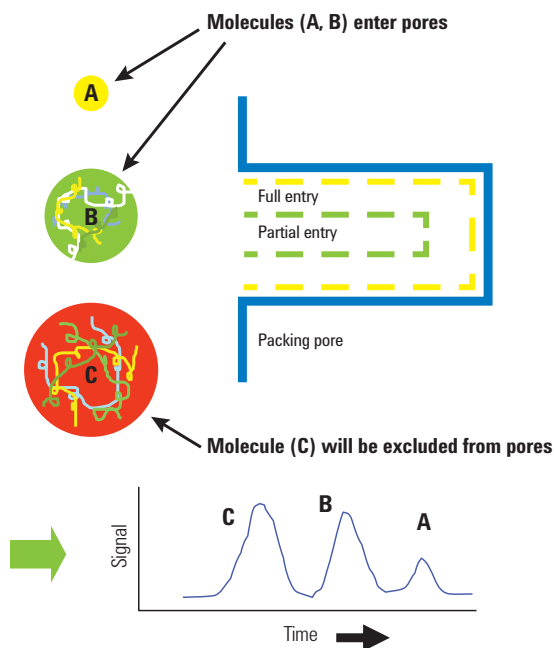

The benefits of SEC are that it allows removal of interferences that can cause poor analytical results. It also reduces the risk of damage to an analytical column, since it may remove higher molecular weight compounds that may irreversibly bind to the stationary phase. With column switching valves, the entire process can be automated. When operated in the non-aqueous SEC mode, sometimes referred to as gel permeation chromatography (GPC), high molecular weight compounds such as lipids, hydrocarbons, oils, and other interferences can be separated and removed. In the aqueous SEC mode, biomolecules such as proteins, polymeric materials, and other water-soluble higher molecular weight species can be removed from an aqueous sample. Aqueous SEC is a useful technique for desalting biological samples since salts are low molecular weight compounds that elute at the total permeation volume late in the chromatogram (see SEC for Biomolecule Sample Preparation).

An important area in the use of SEC for sample cleanup is the determination of trace levels of priority pollutants in complex environmental and food samples. For these types of samples, it is necessary to remove high molecular weight interferences such as lipids, polymers, and pigments before analyzing it by GC or HPLC (and their hyphenated mass spectrometric systems). In fact, there is a regulated SEC cleanup method recommended by the United States Environmental Protection Agency – EPA 3640A. The method allows both self-packed and pre-packed size exclusion columns operated in the non-aqueous SEC mode. Important toxic compounds that are often analyzed include PCBs, PAHs, and pesticides. **Figure 11.2** shows the classical EPA method and depicts the elution profiles of various classes of pollutants. The procedure uses the undesirable chlorinated solvent dichloromethane as the mobile phase. The EPA GPC calibration mixture consists of corn oil (25,000 mg/L), bis(2-ethylhexyl) phthalate (1,000 mg/L), methoxychlor (200 mg/L), perylene (20 mg/L) and sulfur (80 mg/L). **Figure 11.3** provides a chromatogram of the resolution test calibration mixture recommended by the EPA to characterize a SEC column. The chromatogram takes one hour for the separation using a classical SEC (GPC) column.

One approach to speeding up the EPA method is the use of a smaller particle size SEC material packed in a smaller diameter glass column. EcoSpheres, supplied by Agilent, are spherical, microporous resins with a low percent crosslinking. These particles are available as loose microporous media in a dry powder form ready for swelling and gravity packing into glass columns. These microporous materials have no permanent pore structure. Instead, pores are generated when these materials swell in solvents. Microporous packings give higher loadings where high resolution is not required. They can be self-packed into an adjustable bed length glass column. Using the EPA test method, **Figure 11.4** shows that the separation of the EPA test mixture can be done in a third of the time compared to the classical EPA procedure<sup>1</sup>.

Figure 11.2

## Classic Gel Permeation Chromatography Elution Profile for Sample Cleanup

EPA Method 3640

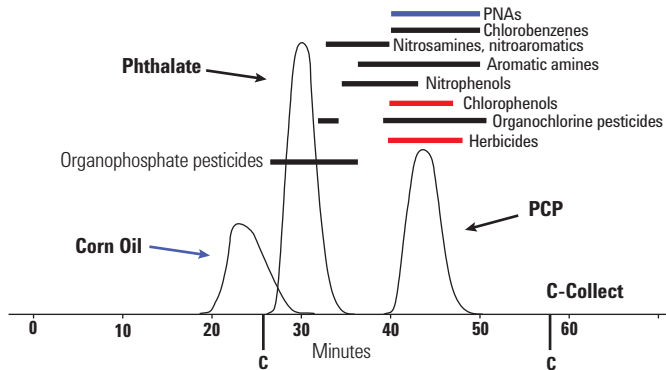

**Mobile phase:** CH<sub>2</sub>Cl<sub>2</sub> – Stat. Phase: BioBeads SX-3 (700 mm x 25 mm)

Total Solvent Consumption: 300 mL

Figure 11.3

## SEC Chromatogram of EPA Calibration Mixture for EPA Method 3640A

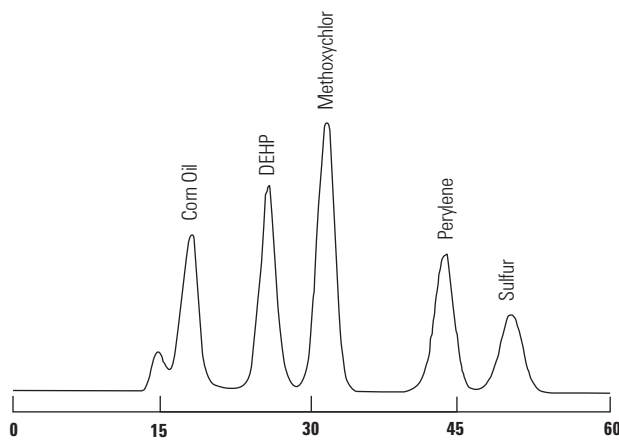

**Chromatography Conditions:**

**Column:** BioBeads SX-3

**Column size:** 25 mm id x 700 mm length

**Bead length:** 490 mm

**Mobile phase:** Methylene Chloride

**Flow rate:** 5 mL/min (Total Solvent Consumption:  
300 mL)



Figure 11.4

**EPA Resolution Mix for Method 3640A Using EcoSphere Column**

**Column:** Glass Column with Swollen EcoSpheres (100 g)  
EPA Resolution Mix for Method 3640A Using EcoSphere Column  
25 mm id x 45 mm length

**Mobile Phase:** THF

**Flow Rate:** 5 mL/min (Total Solvent Consumption: ~100 mL)

**Injection:** 5 mL

**Detector:** UV, 254 nm

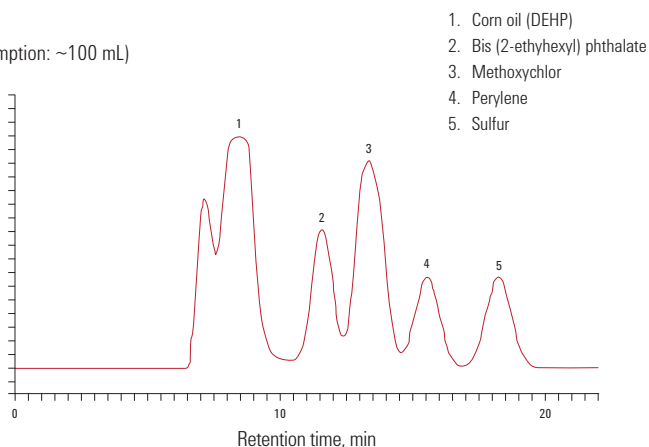

An alternative approach uses an even smaller particle size Agilent PLgel polymeric packing (5-7  $\mu\text{m}$ ) with a 100 $\text{\AA}$  pore. With the smaller particle size, resolution is increased, but so is the pressure, and the loading capacity is reduced. However, the particles themselves are more rigid and can withstand higher pressures, up to 150 bar. The injection of the EPA resolution mixture into this smaller particle column gives sharper peaks and allows an even faster separation as can be seen in **Figure 11.5**. Here, THF was used as the mobile phase, a safer solvent than the chlorinated solvent dichloromethane.

Figure 11.5

**EPA Resolution Mixture Using 5  $\mu\text{m}$  SEC Column**

**Column:** PLgel, 5  $\mu\text{m}$   
7.5 x 300 mm

**Mobile Phase:** THF

**Flow Rate:** 0.67 mL/min  
(Total Solvent Consumption: 12 mL)

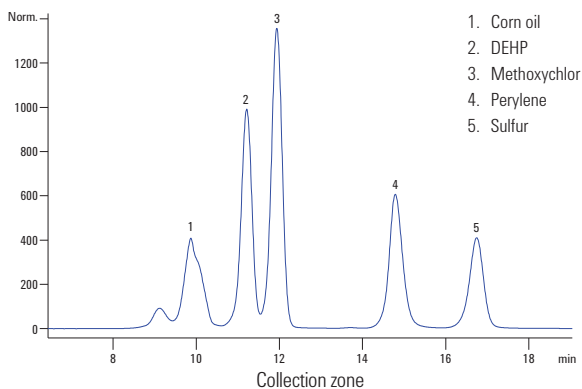

To illustrate how the off-line SEC approach is used as a sample prep technique, a soil sample was spiked with the priority pollutant polynuclear aromatic hydrocarbon (PAH) standards. The soil was first extracted with THF. Two PLgel columns (100 Angstrom pore size, 7.5 x 300 mm dimensions) were used for the cleanup. In **Figure 11.6A**, the PAHs were isolated from the injection of a portion of the soil extract. The two red asterisks represent the point of collection. The large blue baseline drifting upwards is actually the soil extract UV profile. The red portion represents the portion of the chromatogram where the PAHs eluted. This fraction was concentrated, taken up with an HPLC-compatible solvent, then re-injected onto a reversed-phase HPLC column. Gradient elution using water-acetonitrile showed the presence of a number of these priority pollutant compounds (**Figure 11.6B**). Diode array detection allowed the determination of subparts per million concentrations of these contaminants. To keep the pressure a bit lower, Agilent's EnviroPrep, which is a 10 µm macroporous resin in a higher capacity preparative size column (25 x 300 mm), might be used.

Figure 11.6A

**SEC Chromatogram of Soil Extract vs. EPA Resolution Mix (A)**

**Column:** 2X PLgel (7.5 x 300 mm)

**Mobile Phase:** THF

**Detector:** DAD

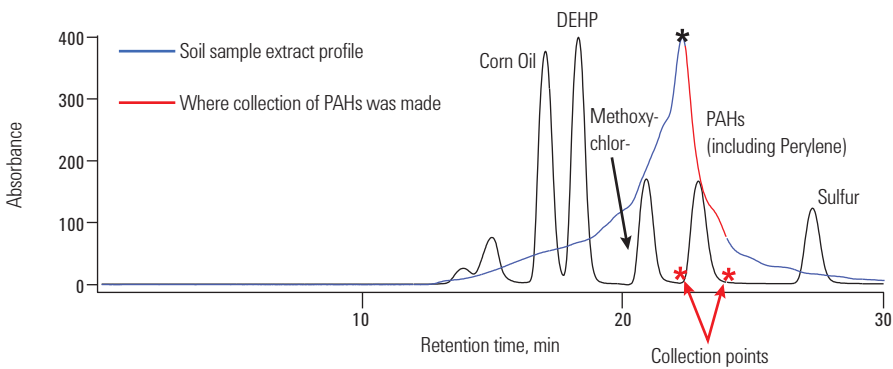

Figure 11.6B

**SEC Chromatogram of Soil Extract vs. EPA Resolution Mix (B)**

**Column:** Reversed-Phase

**Mobile Phase:** Water-ACN gradient

**Detector:** DAD

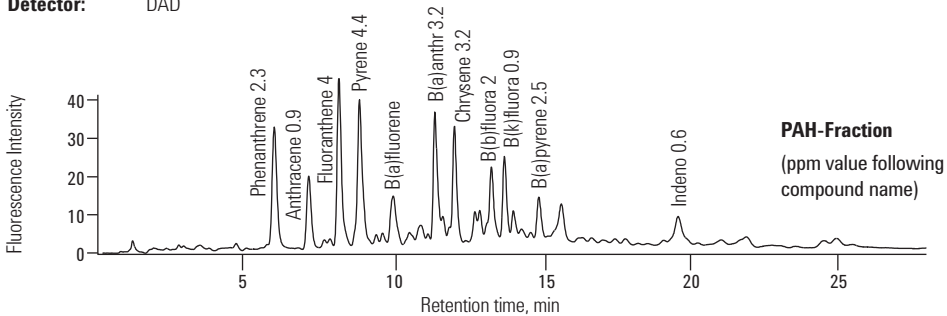

Meat samples often contain high amounts of lipid and may be difficult to analyze without some type of sample cleanup. SEC is an ideal technique for such sample extracts since the lipid material is of higher molecular weight than the small molecules, such as pesticides or certain toxins in which one may be interested. To test the possibility of using SEC to clean up a fresh pork sausage, a sample of the meat was spiked with the EPA Resolution test mix and then extracted. The extractable mass from the meat was consistent with estimated of 25-30% lipid solids.

When dealing with high fat extractable samples, SEC column capacity comes into play and one should make sure that the column dimensions are compatible with the sample loading. For example, the mass capacity for the column used in this example (PLgel 100Å, 7.5 x 300 mm) with acceptable resolution is approximately 40 mg. So this amount is the upper mass injectable limit for the entire sample including the lipid extractables. If larger injections are needed for analyte sensitivity, then a wider bore or longer column may be required.

In **Figure 11.7**, one can see the UV absorption profile (curve in blue) of the lipid background in the SEC chromatogram<sup>2</sup>. The bulk of the lipid would be removed via the SEC route illustrating the cleanup ability of the technique. However, depending on the collection volume and retention window collected, a small amount of lipid extractables might still be collected for subsequent injection into another column or for further sample cleanup.

Figure 11.7

### Cleanup of EPA Resolution Mix-Spiked Pork Sausage Extract Using PLgel 5 µm 100Å Column

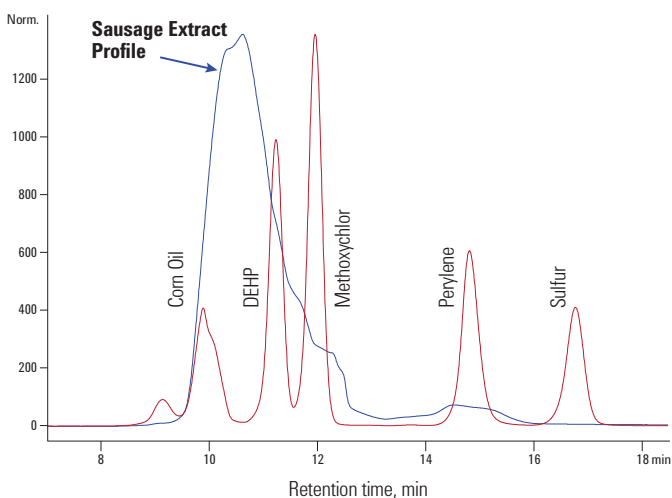

To aid in selecting the best organic SEC column for the cleanup of complex mixtures, calibration curves are often used to evaluate its molecular weight discrimination ability. Here a plot of molecular weight (molecular size) using a series of standards of known molecular weight versus elution volume (or retention time) is constructed (see next section for more details for aqueous SEC columns). This calibration curve gives the user a better idea of which pore size SEC to use for the sample cleanup. Since molecules differ in their molecular sizes defined by their hydrodynamic radius, a calibration plot is only an approximation when dealing with complex mixtures.

# Size Exclusion Chromatography for Biomolecule Sample Preparation

Size exclusion chromatography (SEC) can also be used for separating biomolecules such as proteins from lower molecular weight substances such as contaminants that can include aggregates (monomers, dimers, trimers, tetramers, etc.), excipients, cell debris and other impurities arising from degradation. It is frequently used for removing salts, a process known as *desalting*. The mechanism for the size separation of biomolecules in aqueous solution, sometimes called gel filtration chromatography (GFC), is exactly the same as when using SEC packings with organic mobile phases, as discussed in the previous section. Larger biomolecules spend less time in the pores and elute sooner. Smaller biomolecules spend longer in the pores and elute later.

In order to be biocompatible, packing materials used in aqueous SEC often contain water-wettable functional groups such as diol or glycol that cut down on specific interactions with various functional groups on proteins. Both polymeric- and silica-based packing materials are available for SEC cleanups. Columns packed with polymer-based sorbents are frequently used for polymeric molecules with broad molecular weight distributions such as heparin, starch or cellulose. Proteins and molecules which have a discrete molecular weight are best suited to silica-based stationary phases. It must be remembered that proteins contain numerous amino acids with differing side chain functionalities: acidic, basic, hydrophobic and neutral/hydrophilic. In order to prevent interactions occurring with silica columns, sometimes buffers are needed in the mobile phase. Volatile buffers are recommended if mass spectrometry will be used for downstream detection.

Calibration curves that plot molecular weight (or more correctly size) versus elution volume are useful for determining the proper SEC column for protein mixture cleanup. A hypothetical calibration curve is shown in **Figure 11.8**. Standards of known molecular weight (size) are injected onto the SEC column and their elution volumes determined. Then, when an unknown is injected under the same chromatographic conditions, one can get a good estimate of the molecular sizes of the molecules in the sample and can use this information to select the optimum pore size for the best cleanup of the sample at hand. The green region of **Figure 11.8** where the curve is the flattest provides the best overall chromatographic resolution. **Figure 11.9** shows some actual calibration curves of different pore size SEC packings.

Figure 11.8

### Hypothetical Calibration Curve for Aqueous SEC Column

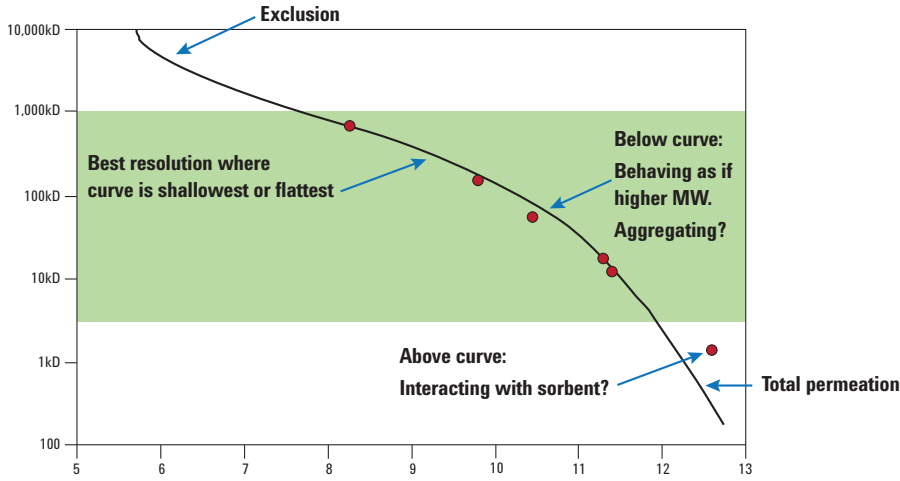

Figure 11.9

### Calibration Curves for SEC Columns with Three Different Pore Sizes

**Column:** Bio SEC-3 Agilent Technologies  
7.8 x 300 mm, 3 µm

**Mobile Phase:** 150 mM Na phosphate, pH 7.0

**Flow Rate:** 1.0 mL/min

**Detector:** UV

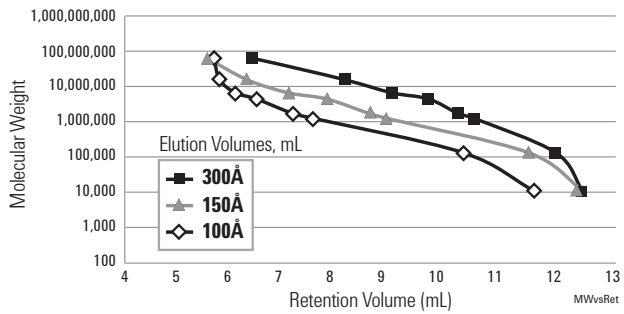

Proteins	MWt	Pore Size*		
		300Å	150Å	100Å
Thyroglobulin	670000	6.34	5.50	5.63
Gamma globulin	158000	8.03	6.24	5.74
BSA	67000	8.90	7.00	6.03
Ovalbumin	45000	9.57	7.70	6.41
Myoglobin	17000	10.12	8.50	7.10
Ribonuclease A	12700	10.40	8.80	7.46
Vitamin B-12	1350	11.90	11.40	10.20

\*Values represent "Retention Volume" on calibration curve

The measurement and potential removal of protein aggregates is an important sample cleanup activity. The size, type, and content of aggregates present in protein biopharmaceuticals can affect both efficacy and formulation – or worse, induce an immunogenic response. Aggregation formations occur through a variety of mechanisms, including disulfide bond formation and non-covalent interactions. Because the size of protein aggregates, including dimers, is sufficiently different from the protein monomer, you can separate the various forms using SEC. In fact, SEC with UV or light scattering is a standard technique for quantifying protein aggregation. **Figure 11.10** provides a chromatogram of a CHO-humanized monoclonal antibody where the dimer is well separated from the monomer. Note that the packing with the 300 Angstrom pore size gave a good separation of the MAb monomer from its dimer as well as some unknown lower molecular weight impurities.

To desalt biological samples, SEC is a widely accepted method. Analytically, aqueous SEC can distinguish between molecules (e.g. proteins) with a molecular weight difference of less than a factor of 2. In desalting, the size difference between the substances being separated is very large (i.e. proteins vs. salts). The pore size of the gel filtration media is chosen so that it completely excludes the larger proteins while allowing the smaller molecules such as salts and other impurities to freely diffuse into all of the pore spaces.

The column is equilibrated with a buffer, which may be the same or different from that of the sample. The larger protein molecules – which can't enter the pores of the media – elute first from the column, followed by the smaller molecules including the salts that diffuse into the pores. If there is no interest in the smaller molecules and salts, they can be directed to waste or, if these substances are of interest, can be directed to a fraction collector for further handling.

Sometimes, it is desirable to have the purified sample collected in a different buffer than the original. If the mobile phase buffer is different from the buffer the original sample buffer, the larger molecules will elute in this new buffer; hence the process that takes place is *buffer exchange*. This approach is particularly useful when volatile buffers are to be substituted for non-volatile buffer for mass spectrometric compatibility.

Figure 11.10

## Intact MAb Monomer and Dimer Separation by SEC

**Column:** Bio SEC-3, 300Å  
5190-2511  
7.8 x 300 mm, 3 µm

**Buffer:** Sodium phosphate buffer, pH 7.0, 150 mM

**Isocratic:** 0-100% Buffer A from 0-30 min

**Flow Rate:** 1.0 mL/min

**Sample:** CHO-humanized MAb, 5 mg/mL – intact

**Injection:** 5 µL

**Detector:** UV, 220 nm

**Temperature:** Ambient

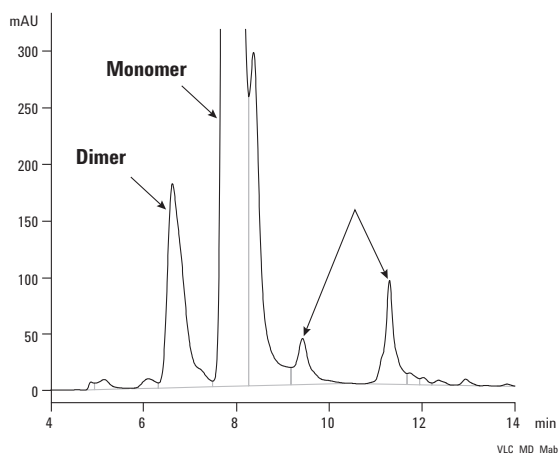

### References

1. Saunders, G.; MacCreath, B. *Sample Cleanup by Gel Permeation Chromatography using Agilent EcoSpheres*, Agilent Technologies Application Note #5990-7583EN, **2011**.
2. Woodman, M.; Stone, P. *Optimizing Sample Loading in Automated Size Exclusion Chromatography Sample Preparation for Small Molecules Analysis from Complex Matrices*, Agilent Technologies Application Note #5989-0181EN, **2003**.

# Column/Flash Chromatography as a Sample Preparation Technique

Prior to the development of SPE for sample pre-treatment, similar purifications were carried out using low pressure or open-column liquid chromatography (LC). **Figure 12.1** depicts the steps in open column LC. In this cleanup approach, adsorbents such as large particle silica gel or alumina are packed into large internal diameter (1-5 cm) glass columns. The sample is injected with a pipette onto the top of the packed bed and solvent is percolated through the column under gravity flow. Fractions are either collected manually or with a fraction collector. The analyte measurement is performed off-line using a spectrophotometer or colorimeter. If analyte concentration is too low in the collected fractions for measurement by the secondary analytical technique, they can be concentrated using other sample preparation techniques, such as evaporation. Relative to HPLC, column efficiency is poor, but the technique is simple to carry out.

Figure 12.1  
Depiction of the Flash Chromatography Process

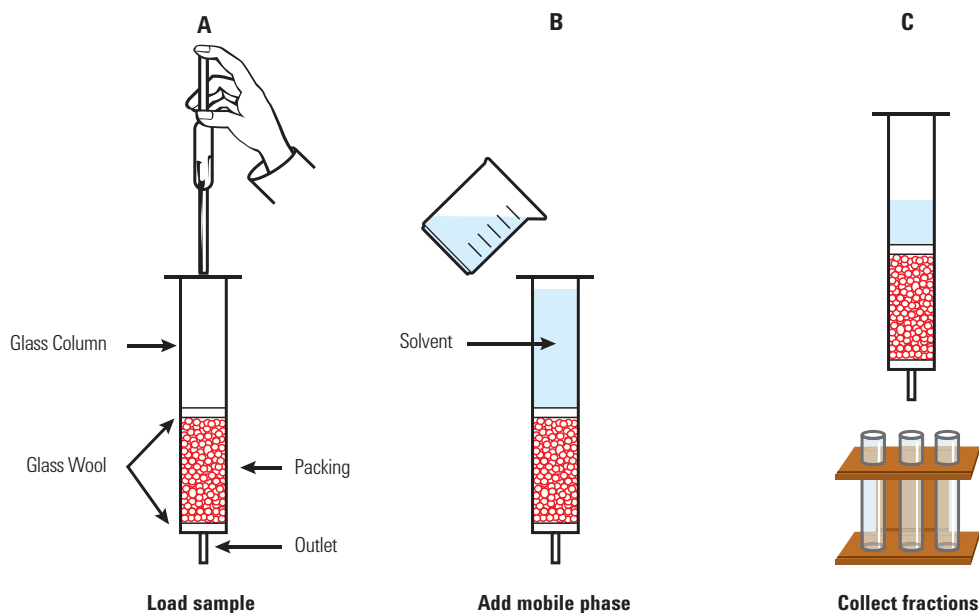



A modern version of column chromatography called flash chromatography has become popular in recent years. Flash Chromatography was first performed in the 60s and 70s by pressurizing open-column work, but this fell out of favor with the introduction of 10  $\mu\text{m}$  and sub-10  $\mu\text{m}$  LC columns. Flash was "rediscovered" in the mid 90s as a technique to rapidly purify mg to g quantities of synthesis mixtures when combinatorial chemistry was "the thing" to do for development of targets for new pharmaceuticals. Traditional column chromatography was too slow, SPE required multiple fraction collection or risk of loss of analyte, HPLC did not have high enough loading, and synthetic chemists found the instruments too complex.

In this technique, convenient pre-packed columns with pre-cleaned adsorbent are used and low pressure (a few bar) is applied to aid flow. A wide variety of pre-packed flash columns are available with diameters ranging from 75-150 mm with masses from 200-9 kg. In addition to the classical adsorbents, newer bonded stationary phases such as C8 or C18 bonded silicas are available, so besides normal phase separations on silica and alumina (neutral, basic, acidic), reversed-phase chromatography can be performed. Popular bonded phases that are available for HPLC are now obtainable for flash chromatography. Instruments are also available to pump mobile phase through the columns at moderate pressures. Modern instruments run gradients and have various flow-through detector options. They are really a subset of HPLC separation instruments but work at lower pressures because the particles used are rather large (greater than 20  $\mu\text{m}$ ) compared to HPLC/UHPLC columns.

The question arises: where does solid phase extraction end and flash chromatography begin? In terms of the size of the container, the mass and particle size of packing, large SPE cartridges very much resemble small flash columns and vice-versa. The main difference is most likely that the flash columns are used for preparative work and large scale cleanup while large SPE cartridges are used to scale up from smaller sizes due to their capacity limitations. In reality, it doesn't matter since both are performing some degree of sample cleanup.

The use of off-line LC (including flash chromatography) as a cleanup technique for GC and HPLC is well documented. In liquid phase flash chromatography, the cleanup step can be performed in a different mode than the HPLC mode and can therefore be orthogonal to the subsequent HPLC separation providing a high degree of sample cleanup. This multidimensional flash LC-HPLC experiment can also provide a cleaner sample to be presented to the HPLC column which serves to prolong its lifetime. Samples can often be fractionated using step gradients. There are many sample cleanup methods for pesticides in environmental samples and drugs in biological fluids where the techniques have been used successfully. In GC, adsorbents such as Florisil and Alumina have long been used for sample cleanup prior to pesticide analysis. In some cases, the use of thin layer chromatography (TLC) can be helpful in selecting the best set of LC conditions for performing flash chromatography. For example, TLC can help to determine what solvents can be used for step gradient elution or for solvent selection to elute analytes but not matrix compounds from a column.

# Column-Switching (On-Line SPE) as a Sample Preparation Technique

Column switching – also called 2D LC, multidimensional column chromatography, coupled-column chromatography, or “box car” chromatography – is a powerful technique for the separation and cleanup of complex, multi-component samples. In this approach, all or a portion of the chromatogram from an initial column (Column 1) is selectively transferred to a second column (Column 2) for further separation (see **Figure 13.1**). In the context of sample preparation, Column 1 can be an SPE column, cartridge, or disk, and the technique is referred to as “on-line SPE”.

Column switching (C-S) is used for:

- Removal of sample components detrimental to Column 2
- Removal of late-eluters prior to injection onto Column 2
- Selective removal of interferences that overlap analyte peaks in Column 2
- An alternative to gradient elution
- Trace enrichment, also a sample preparation technique

The achievement of one or more of these goals often results in increased sample throughput versus the use of single-column operation. The basic goal of C-S is to maximize the transfer of the analyte band into Column 2, while minimizing the transfer of interfering compounds, i.e., the same goal as in sample preparation using off-line SPE.

Figure 13.1

## Principle of Chromatography as a Sample Preparation Technique (Heart Cutting)

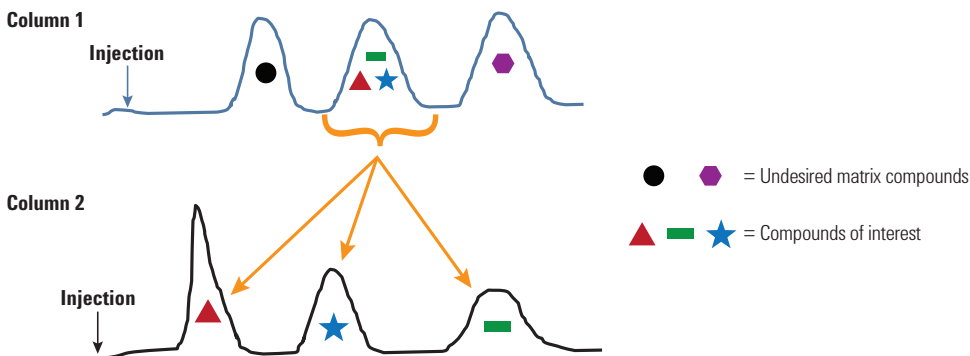

In HPLC, C-S is achieved by connecting Column 1 to Column 2 via a high-pressure switching valve. In this way, the sample is partially separated on Column 1, and a fraction containing the analyte(s) of interest is directed to Column 2 for final separation and subsequent detection. C-S can involve combinations of LC, GC, TLC, SFC, and CE. In this Chapter, only LC-LC methods will be covered. While C-S is similar to the HPLC analysis of off-line fractions provided by SPE (see Chapter 9), in its usual practice, several major differences exist:

- SPE cartridges are typically used only once and discarded; Column 1 in C-S is used repeatedly, although often for fewer injections (e.g., 50-100) than usual for an HPLC column. Therefore, in C-S, extra washing/backflushing steps may be required to ensure interferences are removed from Column 1. Otherwise, these impurities can impair the performance of Column 1 or show up as extraneous peaks which elute from Column 2 in later analyses.
- Column 1 has a higher efficiency (smaller particle diameter,  $d_p$  in the 3 or 5  $\mu\text{m}$  range) compared to an SPE cartridge ( $d_p$  in the 40  $\mu\text{m}$  range). Thus, analyte bandwidths from Column 1 are narrower, which allows better resolution on Column 1 compared to an SPE cartridge, and cleaner samples presented to Column 2 for an easier final HPLC separation.
- Since C-S is performed in a closed system, there is less of a chance of sample loss (e.g. oxidation) or concentration change (e.g. evaporation) than in SPE usually performed in an open-air environment.
- Many valve configurations are possible for heart cutting, backflushing, diverting contaminants directly to waste, etc.

Of course, there are a few disadvantages associated with column switching. First, the system requirements are more complex than off-line SPE – valves, tubing, precise timing requirements, and electronic interfaces are required. Samples must be particulate-free since the frits on Column 1 may retain them and eventually block the column, or at least, experience a pressure buildup. Strongly retained sample components and matrix interferences can build up on the initial column requiring replacement or periodic cleaning.

# Principles of Operation

Column-switching can be carried out either manually or automatically, but most applications of C-S are fully automated. Low-dead-volume switching valves are used and automatically actuated by timers or time-programmable events from an HPLC system controller. An important experimental requirement for C-S is the complete transfer of analyte from Column 1 to Column 2. This requires close control of the switching time. High-pressure switching valves are commercially available with 2 to 10 (or more) ports, 6- and 10-port valves being used most often. C-S can be carried out with a single pump with some elaborate reconfiguration, but multiple pumps (at least two) are usually preferred.

One frequently used C-S system (see **Figure 13.2**) employs a two pump configuration with Column 1 placed within a six-port valve that is placed across two of the ports and before Column 2. In **Figure 13.2A**, the valve position allows pump A mobile phase from Column 1 to bypass Column 2 and flow directly to waste. Thus, undesired sample components injected into Column 1 that were weakly retained can be removed and sent to waste. Next, in **Figure 13.2B**, the valve position is switched to allow mobile phase delivered from pump B to pass through Column 1 onto Column 2. Thus, any components remaining in Column 1 could be “backflushed” to Column 2, rather than eluted in the same direction as the sample was loaded, for further separation and detection. Forward-elution may be applied if contaminants including particulates are also trapped on the loading end of Column 1, which would interfere with the analysis on the second column (if backflushing was used) into Column 2. The mobile phase strength and timing considerations can allow selective elution of sample components remaining in Column 1 after the initial sample loading.

Figure 13.2

## Experimental Setup for Sample Prep Cleanup by Backflushing

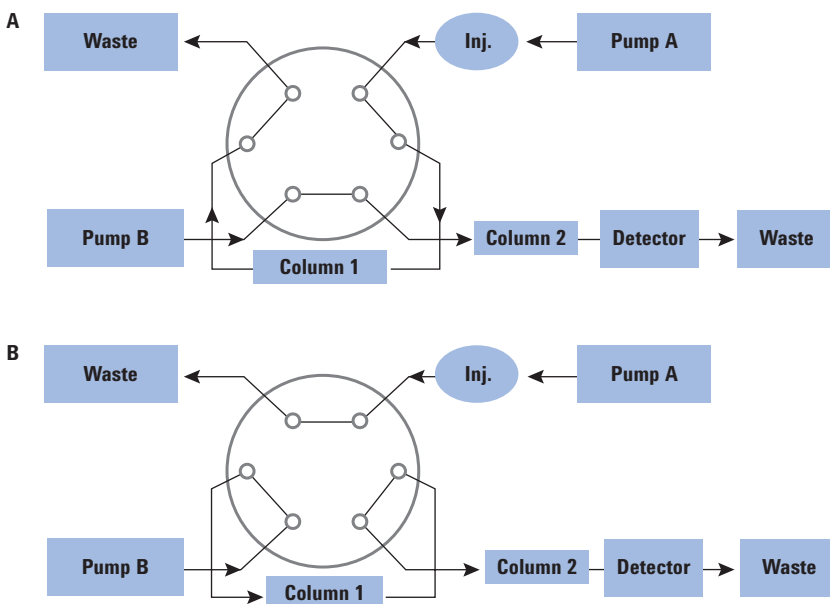

# Examples of Column-Switching for Sample Cleanup by LC

**Sudan Dyes in Spices<sup>1</sup>:** Sudan dyes are azo dyes, and based on findings of the IARC (International Agency For Research on Cancer), are classified as Group 3 of the potential carcinogenic compounds. These compounds have been banned in food products in the EU, Japan, and United States since 2004. If these compounds are detected in spices or products containing spices such as spice blends, the food products must be recalled and destroyed. The following three main Sudan dyes were studied: Sudan Orange G, Sudan 1 (Sudan I), and Sudan 2 (Sudan II).

In this example, the valving configuration shown in **Figure 13.2** is used for sample cleanup. The initial sample preparation of spice products, such as chili or paprika powder, for subsequent Sudan dye analysis is relatively simple and straightforward. The powder is extracted with acetonitrile using an ultrasonic bath. The liquid is cooled, filtered, and injected into the HPLC column. This extract contains a substantial amount of colored and non-colored compounds, and gives a complex LC-MSD chromatogram as shown in **Figure 13.3**. On-line sample cleanup is performed by a precolumn (Column 1) – referred to as a cleaning column in reference 1 – which is achieved by a valve switching between the analytical column (Column 2 in **Figure 13.2**), and cleaning column. This process eliminates severe contamination of the analytical column from oils and other residues present in the spices, as well as minimizing ion suppression in the mass spectrometer.

Figure 13.3

## Paprika Powder Extract Analyzed Using MSD in Scan Mode

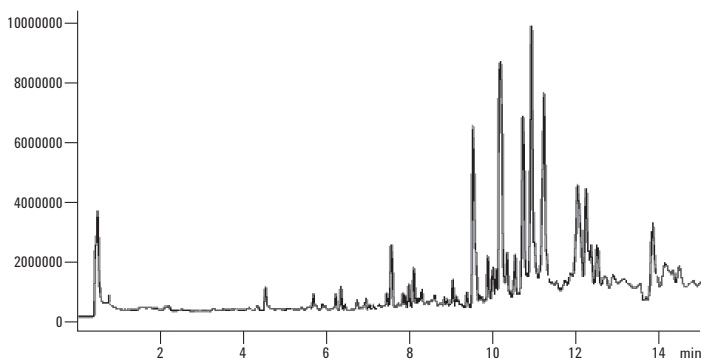

### Conditions

#### Columns:

Cleanup Column (Column 1): Agilent ZORBAX RRHT Eclipse Plus C18, 2.1 x 30 mm, 1.8  $\mu$ m

Analytical Column (Column 2): Agilent ZORBAX RRHD Eclipse Plus C18, 2.1 x 100 mm, 1.8  $\mu$ m

Mobile Phases: A = Water,  
B = Acetonitrile (for analytical pump, the water was modified with 400  $\mu$ L TFA)

Analytical Pump Flow: 0.5 mL/min; stop time 15 min; post time 3 min

Cleaning Pump Flow: 0.3 mL/min; stop time no limit

Gradient for Analytical Pump: at 0 min 5% B, at 5 min 95% B

Isocratic for Cleaning Pump: 5% B

Column Oven: 40 °C on both sides, valve switch = next run

Valve Switch: at 2.0 min position B

Injector: 1  $\mu$ L injection volume, needle wash for 6 s

Using the valve assembly setup already shown in **Figure 13.2**, the workflow used for cleaning the paprika powder extract on-line is as follows:

- 1) The sample is introduced into the shorter cleaning column (valve position **Figure 13.2A**). The mobile phase is provided by pump A. All compounds eluting within 1 min are sent to waste.
- 2) The valve is switched after 1 min to operate the cleaning column and the analytical column in series (valve position **Figure 13.2B**). Pump B now provides the mobile phase. The analytical gradient starts and the peaks of interest elute from the analytical column (Column 2).
- 3) The valve is switched again to its initial position and all remaining compounds are discarded (valve position **Figure 13.2A**). The acetonitrile strength for the cleaning column is increased to 95% to flush out all remaining compounds. The cleaning column (Column 1) is then equilibrated to the starting conditions.

Using the Agilent 1290 Infinity UHPLC System equipped with an Agilent 6140 quadrupole mass spectrometer operated in the SIM mode, the Sudan red compounds were measured with the high sensitivity. The target masses were 215, 249, and 277. **Figure 13.4** shows an overlay of standard and sample extract chromatograms. Compared to **Figure 13.3**, the chromatograms were much less cluttered after on-line cleanup and SIM detection, since compounds eluting prior to or after the Sudan dyes were diverted to waste. Although not depicted here, data was collected showing that the ion suppression effect of the matrix components was reduced. For the three main Sudan dyes, the Minimum Detection Quantity (MDQ) was approximately 100 µg/kilogram for each dye<sup>1</sup>.

Figure 13.4

## Overlay of Standard and Sample Extract LC-MSD Chromatograms in SIM Mode

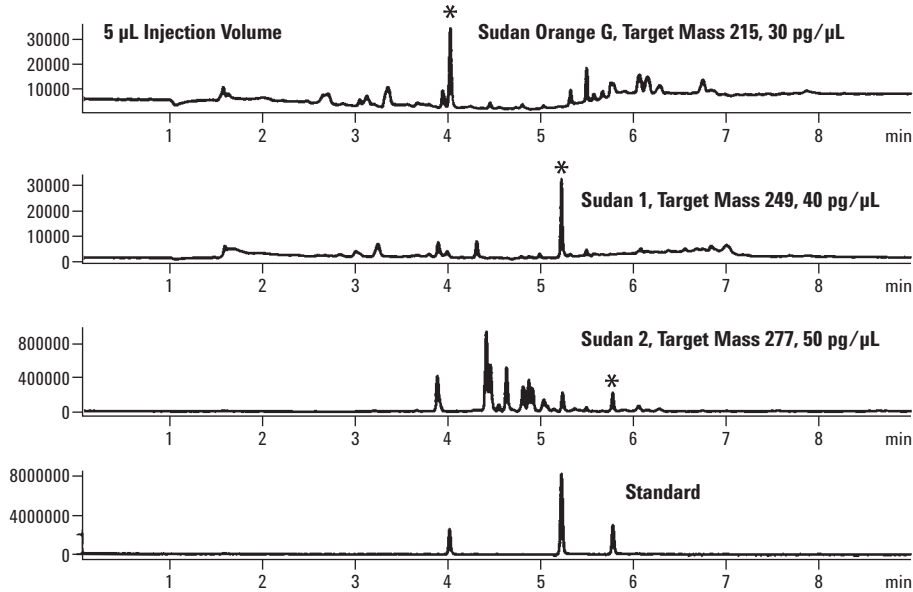

### Conditions

#### Columns:

Analytical Column: Agilent ZORBAX RRHD Eclipse Plus C18,  
2.1 mm x 100 mm, 1.8 µm

Cleaning Column: Agilent ZORBAX RRHT Eclipse Plus C8,  
2.1 mm x 30 mm, 1.8 µm

Mobile Phases: A = Water, B = Acetonitrile Analytical  
pump water + 400 µL TFA

Flow Analytical Pump: 0.5 mL/min; stop time 9 min;  
post time 3 min

Flow Cleaning Pump: 0.5 mL/min; stop time no limit

#### Gradient for

Analytical Pump: At 0 min 20% B; at 1 min 20% B;  
at 5 min 95% B

#### Gradient

Cleaning Pump: At 0 min 20% B;  
at 6.5 min 20% B;  
at 6.6 min 95% B;  
at 8.1 min 20% B

Column Oven: 40 °C on both sides, valve switch = next run

Valve Switching: At 0 min position A, at 1 min position B,  
at 6.5 min position A

DAD: 220/20 nm, Ref = off, 450/20,  
PW >0.0012 min, 20 Hz, slit width 4 nm

Injector: 1 (standard) or 5 µL (spiked extract) injection  
volume, needle wash for 6 s

#### MSD:

Peak width 0.03 min;  
Positive SIM parameters for  
Mass 215, 249, and 277, fragmentor = 100;  
Actual dwell 45;  
Gas temp = 350,  
Drying gas = 12 L/min;  
Neb pres = 35 psig;  
V<sub>cap</sub> positive = 3000 V

\* : shows location of peak for parent Sudan dye

**Herbicides in Water Using Trace Enrichment:** Trace enrichment involves the concentration of small amounts of organics from a large sample volume (typically potable water or source aquifers) by passing it through a trapping column and transferring the concentrated analytes into another HPLC column for further separation. Herbicide contamination in water bodies is monitored to mitigate adverse health impacts. Sensitive methods for detecting and quantifying trace levels of these chemicals are necessary to meet regulatory requirements.

Using a similar instrumental configuration as depicted in **Figure 13.2**, eight chlorinated herbicides were isolated on an enrichment column (Agilent ZORBAX SB-AQ, 2.1 x 30 mm, 1.8  $\mu$ m) then transferred to an analytical column (Agilent ZORBAX SB-C18, 2.1 x 50 mm, 1.8  $\mu$ m) for separation, followed by sensitive diode array detection (DAD)<sup>2</sup>. Using less than 2 mL of herbicide-containing water, the entire trapping process took less than 3 min and the full cycle time was only 15 min (see **Figure 13.5**). The sensitivity of the method achieved the detection limits prescribed in Method 555 by the United States Environmental Protection Agency (EPA) (0.5 ng/mL for picloram and 1.7 ng/mL for dichlorprop). The RSD values for peak areas, peak heights, and retention times were all less than 1%.

Figure 13.5

### Chromatogram of a Sample Containing 50 ppb of Each of the 8 Analytes

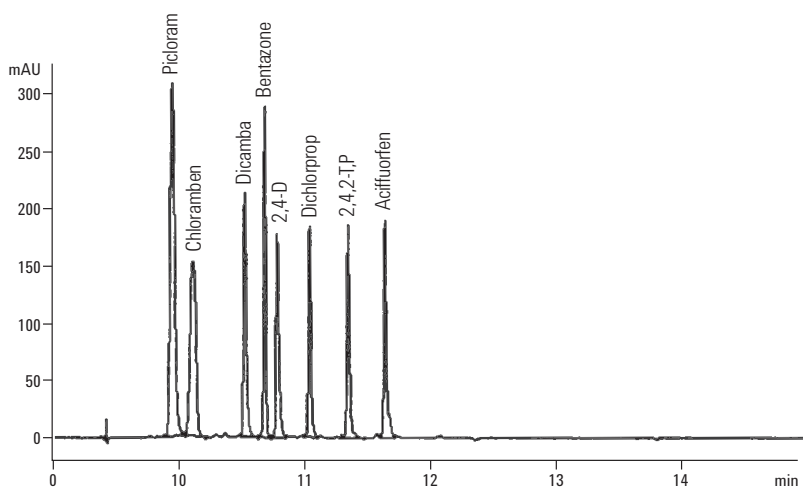



Other uses of column switching are shown in **Table 13.1**. The beauty of such systems is that the processes can be automated, thus improving quantitation and reproducibility, as well as decreasing the labor content of the assay.

**Table 13.1**

<b>Examples of Column Switching as a Sample Preparation Technique</b>			
<b>Analyte(s)</b>	<b>Matrix</b>	<b>Methodology</b>	<b>Reference</b>
Immunosuppressants	Plasma and whole blood	Protein precipitation followed by trapping of IS on Column 1; backflush removal of matrix compounds and elution to Column 2 for analysis by LC-MS/MS	5
Neomycin and Screening Aminoglycosides	Milk	Extraction of ion pairs on short fused silica capillary RPC column; directly eluted to MS-MS	6
Indometacin	Plasma	Used ISRP (internal surface reversed-phase) Column 1; proteins are excluded but small drug molecule retained, analyte switched to analytical column for analysis by LC-DAD	7
Nortriptyline		Biotrap exclusion Column 1 used to remove proteins; drug is eluted into RP Column 2 and detected by DAD	8
25-Hydroxy Vitamin D2 and D3		Protein precipitation followed by trapping on Poroshell 120 column; removal of matrix interferences and elution to Column 2 for separation and analysis by LC-MS/MS	9
Beta-blockers	Groundwater	Large volume injection with preconcentration followed by LC-fluorescence and LC-TOF MS	10
17 $\beta$ -Estradiol	Plasma	Underivatized estradiol trapping column (reversed-phase) and analytical column (same)	11
Oxygenates and Aromatics	Hydrocarbon processing stream	GC-GC application using Dean's switching for heart cutting analytes	12
Digoxin	Human serum	Restricted access media in Column 1 excludes proteins but retains small molecule; proteins flushed to waste and small molecule eluted to Column 2, a short chain reversed-phase column	13

Related to column switching, comprehensive multidimensional chromatography (sometimes called 2D chromatography if two columns are being used and referred to as LC x LC or GC x GC) is mainly used when the goal is to analyze every single compound eluting from Column 1. In comprehensive LC x LC, the flow from either pump is never stopped and separations take place on both columns simultaneously. The flow of Column 1 is relatively slow since the effluent from that column is continuously collected in one of two holding loops across ports of a 10-port valve. The two holding loops are of sufficient size to hold the entire output from Column 1 while a very fast analysis is occurring on Column 2, usually only a minute or two. Once the separation in Column 2 is completed and the column quickly regenerated, the contents of the initial holding loop is switched to Column 2 and another fast analysis starts again. This time, the second holding loop begins collecting more effluent from Column 1 and the process repeats itself. The main difference in column switching experiments is that we may only be interested in one, two, or several bands eluting from Column 1 and not the entire sample. In GC x GC, a thermal modulator is employed and the effluent gas from GC Column 1 is cryogenically trapped to collect and concentrate analytes while the separation on GC Column 2 is also performed extremely fast, often under one minute. The trapped sample is then rapidly heated and directed to Column 2 for further separation while a new fraction is simultaneously trapped in the cryogenic modulator. For more information on 2D chromatography, see references 3 and 4.

For additional Agilent Application Notes focusing on SPE,  
please visit [www.agilent.com/chem/online-spe](http://www.agilent.com/chem/online-spe)

#### References

---

1. Gratzfeld-Huesgen, A. *On-line Sample Cleanup on the Agilent 1290 Infinity LC Using a Built-in 2-position/6-port Valve*, Agilent Technologies Application Note #5990-5255EN, **February, 2010**.
2. Kailasam, S. *Trace Analysis of Chlorinated Herbicides in Water with On-line Enrichment*, Agilent Technologies Application Note #5990-6922EN, **December, 2010**.
3. Mondello, L. (Ed.) *Comprehensive Chromatography in Combination with Mass Spectrometry*, Wiley, New York, **2011**, ISBN-10: 0470434074 and ISBN-13: 978-0470434079.
4. Cohen S.A.; Schure, M.R. (Eds.) *Multidimensional Liquid Chromatography: Theory and Applications in Industrial Chemistry and the Life Sciences*, Wiley-Interscience, New York, **2008**, ISBN: 0471738476.
5. McCann, K. ASMS 2011, Paper ThP166, *A Rapid Quantitative Analysis of Five Immunosuppressant (IS) Drugs in Blood by LC-MS/MS for Clinical Research*, **June, 2011**.
6. Lu, C.-Y.; Feng, C.-H. *J. Sep. Sci.* **2006**, *29*, 2143-2148.
7. Koizumi, K. *Automatic HPLC Analysis of Indometacin in Plasma Using Column Switching*, Agilent Technologies Publication #5968-7205, **August, 1999**.
8. Ricker, R. *Analysis of Nortriptyline in Plasma*, Agilent Technologies Publication #5988-6398EN, **April, 2002**.
9. Chun, M.R.; Jung, H.-J.; Yang, J.S.; Kim, H.-Y.; Lee, S.-Y. *Mass Spectrometry: Applications to the Clinical Lab* (MSACL 2012) Poster 55, **January, 2012**.
10. Galera, M.M.; Vazquez, P.P.; del Mar, M.; Vazquez, P.; Garcia, G.; Amate, C.F. *J. Sep. Sci.* **2011**, *34*, 1796-1804.
11. Szczesniowski, A. *Mass Spectrometry: Applications to the Clinical Lab* (MSACL) Tuesday Lunch Workshop, **January, 2012**.
12. McCurry, J.; Quimby, B. *Two-Dimensional Gas Chromatographic Analysis of Oxygenates and Aromatics in Gasoline Using a Heart Cutting Technique*, Agilent Technologies Application Note #5988-6696EN, **May, 2002**.
13. Sudergat, H.; Unger, K.K.; Emmert, J.; Wendt, J.; Mandel, F. *Determination of Digoxin in Human Serum by LC/MS with On-line Sample Preparation*, Agilent Technologies Application Note #5988-4364EN, **October, 2001**.

# Sample Preparation Methods for Solid Samples

Usually, a sample must be in a liquid state prior to HPLC or GC analysis. Some insoluble solids contain soluble analytes such as additives in a polymer, fats in food, and polyaromatic hydrocarbons (PAHs) in soil. Contacting the sample with solvent allows the extraction of analytes into the solvent, following which the solvent is separated from the solid residue by decanting, filtration, or centrifugation. The solution is further treated, if necessary, prior to HPLC or GC analysis. In Chapter 2, **Tables 2.2 and 2.3** summarized techniques used for the extraction ("leaching") of soluble analytes from an insoluble solid matrix. We will refer back to these earlier tables in this chapter.

## Traditional Extraction Methods

No one solvent extraction technique can be used for all samples. **Table 2.2** listed several traditional methods for the pre-treatment of solid samples. Most of these methods (e.g. Soxhlet extraction and leaching) have been used for more than 100 years, are time tested, and accepted by most scientists. Regulatory agencies such as the United States Environmental Protection Agency (U.S. EPA), the Food and Drug Administration (FDA), and their equivalents in other countries readily approve these classical methods for extracting solid samples. However, these methods often use large amounts of organic solvents, which have encouraged a trend toward miniaturization in recent years. In addition, some of the older extraction techniques require more glassware and labor.

Solvent extraction can assume many forms. The shake-flask method, which involves addition of a solvent to the sample followed by agitation, works well when the analyte is highly soluble in the extraction solvent and the sample is quite porous. For fast extraction, the sample should be finely divided (see Chapter 4, Particle Size Reduction). Heating or refluxing the sample in the solvent can speed up extraction. For faster and more complete extraction, ultrasonic agitation (sonication) often allows more effective solid-liquid contact, plus a gentle heating which aids extraction. Sonication is a recommended procedure for the pre-treatment of many solid environmental samples, such as the U.S. EPA Method 3550 for extracting non-volatile and semi-volatile organic compounds from solids such as soils, sludge, and wastes. In this method, different extraction solvents and sonication conditions are recommended, depending on the type of pollutants and their concentration in the solid matrix.

In forced-flow leaching, the solid is packed into a short, stainless steel column (e.g., 20 x 0.4 cm), and toluene is pumped under pressure (40 psi) through the column heated at 100-110 °C. Results are comparable to Soxhlet extraction (below), but the extraction time is significantly reduced (e.g. 24 hr to 1/2 hr). Good recoveries of polyaromatic hydrocarbons from coal-ash samples have been demonstrated by this technique<sup>1</sup>. An advantage of forced-flow leaching is that the sample is subjected continuously to fresh, hot solvent, and the effluent from the column is easily collected for further treatment.

Soxhlet extraction has been the most widely used method for the extraction of solids. In this procedure, the solid sample is placed in a Soxhlet thimble (a disposable porous container made of stiffened filter paper), and the thimble is placed in the Soxhlet apparatus. Refluxing extraction solvent condenses into the thimble and extracts the soluble analytes (**Figure 14.1**). The apparatus is designed to siphon the extract each time the chamber holding the thimble fills with solvent. The siphoned solution containing the dissolved analytes returns to the boiling flask and the process is repeated until the analyte has been removed from the solid sample and isolated in the flask. Soxhlet extractions are usually slow (12 to 24 hours or more), but the process takes place unattended. The most common extractors use hundreds of milliliters of very pure (and very expensive) solvent, but small-volume extractors and thimbles are available for mg-size samples.

Figure 14.1

### Diagram of a Traditional Soxhlet Extraction Apparatus

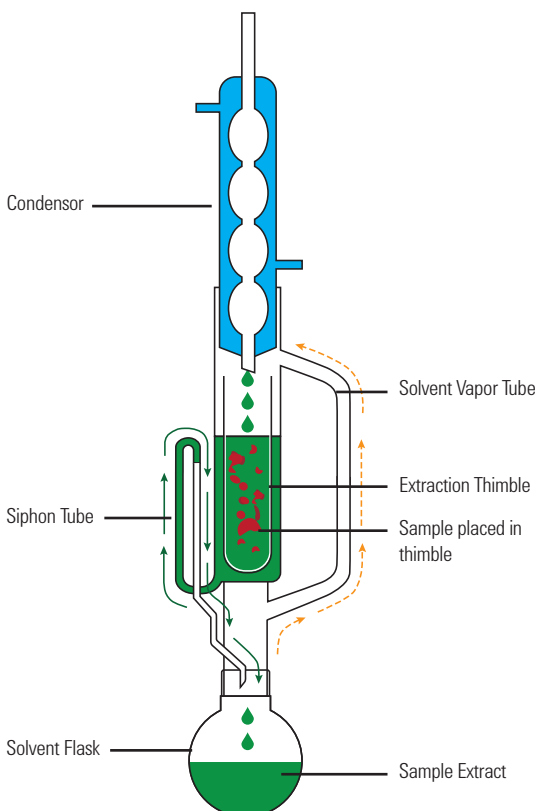

In Soxhlet extraction, fresh, hot extraction solvent is always presented to the sample, thus providing maximum analyte solubility. Since the extracted analyte is allowed to accumulate in the boiling flask, it must be stable at the boiling point of the extraction solvent. Method development consists of finding a volatile solvent (e.g., boiling point < 100 °C) which has a high solubility for the analyte and a low solubility for the solid sample matrix. As the oldest form of efficient extraction, Soxhlet extraction is the accepted standard for comparison with newer extraction technologies such as SFE, pressurized fluid extraction (PFE)/accelerated solvent extraction (ASE), and microwave-assisted extraction (MAE).

# Newer Extraction Methods for Solid Materials

For many years, the solvent extraction methods of **Table 2.3** proved adequate for most laboratories. The newer methods of **Table 2.4** were developed to address an increasing need for greater productivity, faster assays, and increased automation. Some of these methods are automated, more convenient versions of the methods of **Table 2.3**. Other techniques have been developed which are based on new principles. For the most part, these newer approaches are more expensive in terms of the initial purchase price of the equipment, but result in lower cost per sample and are faster. Most of these newer methods are based on performing solid extractions at increased temperatures and pressures. **Table 14.1** provides background information on how these parameters accelerate extractions. The abbreviations used in the table are covered in the following sections.

Table 14.1

<b>Most Modern Solid Extraction Techniques Use Increased Temperature and Pressure</b>
<b>Influence of Temperature</b>
<ul style="list-style-type: none"><li>• Increased analyte solubility</li><li>• Increases diffusion rates and mass transfer</li><li>• Lowers viscosity vs. room temperature</li><li>• Activation energy of desorption is more readily overcome</li><li>• Kinetics of desorption and solubilization more favorable</li></ul>
<b>Influence of Pressure</b>
<ul style="list-style-type: none"><li>• Forces liquid into pores of porous material</li><li>• Extraction cell fills faster (PFE/ASE, SFE)</li><li>• Extraction cell empties faster</li></ul>
<b>Combined Temperature and Pressure</b>
<ul style="list-style-type: none"><li>• In SFE, varying pressure and temperature changes the density of the supercritical carbon dioxide and therefore changes its solvation power</li><li>• In ASE/MAE, T and P combine to accelerate rate and extent of extraction</li></ul>

In 1974, Edward Randall made a major improvement in the Soxhlet extraction technique that reduced the extraction time dramatically<sup>2</sup>. In his method, the sample was totally immersed in the boiling solvent. Compared to the classical Soxhlet method where the condensed extracting solvent's temperature is slightly below the boiling point, the Randall method was faster because analytes are more soluble in hot solvent than in warm solvent. The operation of the Randall adaptation is depicted in **Figure 14.2**. First, the thimble is lowered into the boiling solvent until the appropriate extraction takes place. Then, to flush residual extract from the sample, a rinse step follows. In this second stage, the thimble is raised above the boiling solvent for a period of time until residual extract is removed from the solid material by the condensed solvent, just as is performed in the original Soxhlet experiment. Finally, the drying step removes the solvent from the solvent flask and concentrates the analyte for further processing. In this step, by closing a solvent return valve, the condensed solvent is redirected away from the sample and boiling solvent and collected in a reservoir for possible re-use or disposal. In some systems, there is a fourth step where the sample cup is lifted from the heat source and allowed to evaporate further without the chance of sample overheating, boiling dry, or potential oxidation. The Randall approach can decrease the extraction time by as much as a factor of 10 compared to traditional Soxhlet extraction.

Figure 14.2

### Principles of Operation of a Modern Soxhlet Extraction System

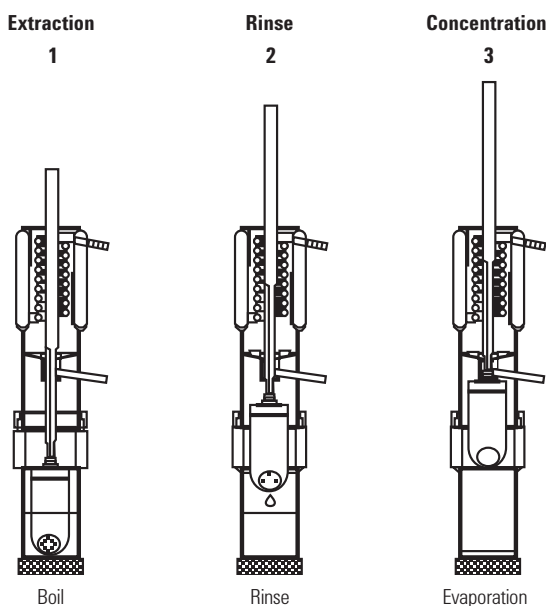

Modern Soxhlet extraction systems can run completely unattended, offer temperature programming, solvent reclamation, and numerous safety features. Most solvents can be used, although diethyl ether is not recommended for obvious reasons. Automated Soxhlet extraction is approved by the U.S. EPA for the extraction of organic analytes from soil, sediment, sludge, and waste solids (Method 3541).

With the advent of fully automated systems, much of the drudgery of classical Soxhlet extraction has been reduced. Nevertheless, some interesting approaches to improve on the technique have been proposed. Focused microwave-assisted Soxhlet extraction could even speed the extraction time even further with certain microwave absorbing solvents for environmental solid samples<sup>3-4</sup>. The further application of using superheated water as an extraction solvent makes the process much more environmentally friendly<sup>5</sup>. When pollutants are present in aged soils, they are more difficult to extract by Soxhlet extraction than when present in spiked soils. An in situ derivatization technique was found to more easily release pentachlorophenol (PCP) from sandy soil<sup>6</sup>. Using the acetylation agents TEA-acetic anhydride and pyridine-acetic anhydride, the authors found that the yields were four times greater and the extraction time shorter with in situ derivatized PCP in soil than by the traditional Soxhlet extraction of non-derivatized PCP in the same soil.

# Supercritical Fluid Extraction (SFE)

The physical state of a substance can be described by a phase diagram which defines regions corresponding to the solid, liquid, and gaseous states. Points along the curves in the diagram define situations where there is equilibrium between two of the phases. In the phase diagram for carbon dioxide ( $\text{CO}_2$ ; Figure 14.3), the line between liquid and gas has a terminus (the critical point), unlike the line between solid and liquid. The critical point is defined by the critical temperature  $T_c$  and critical pressure  $P_c$ ; beyond the critical point (the supercritical region) a gas cannot be converted into the liquid state, regardless of pressure. A SF exhibits gas-like mass transfer properties and liquid-like solubility properties, enabling it to carry out solvent extractions much more efficiently and rapidly than a solvent in the liquid state. Today, supercritical fluid extraction (SFE) is used for the extraction of non-polar and moderately polar analytes from solid matrices. Several references<sup>7-11</sup> describe the instrumentation, methods development, and applications of SFE.

Figure 14.3  
Phase Diagram of  $\text{CO}_2$

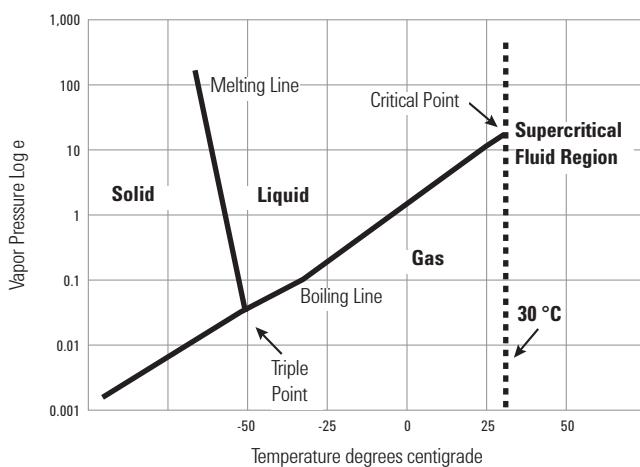

Fluids that can be used for SFE include  $\text{CO}_2$ ,  $\text{NH}_3$ ,  $\text{N}_2\text{O}$ , and pentane.  $\text{N}_2\text{O}$  and pentane are flammable, and  $\text{NH}_3$  is chemically reactive and corrosive.  $\text{CO}_2$  is used most often for SFE as it is safe, chemically inert, non-toxic, non-corrosive, and available in high purity at a reasonable cost.  $\text{CO}_2$  is easily removed from the collected analyte and it causes no disposal problems. Low-density supercritical  $\text{CO}_2$  has the polarity of hexane; i.e., it is non-polar. However, SF polarity increases with density, especially near the critical point; so at its highest density, SF- $\text{CO}_2$  resembles the polarity of solvents such as toluene, benzene, and ether.

While pure  $\text{CO}_2$  is able to extract a wide variety of non-polar and moderately polar analytes, it is less effective for more polar compounds. In other cases, it may not be able to displace analytes that are strongly adsorbed to the solid matrix. The addition of a small amount (up to 10% by volume) of polar organic solvents (methanol, methylene chloride, acetonitrile, toluene, etc.) to the  $\text{CO}_2$  can enhance its ability to dissolve more polar analytes and displace these compounds when they are adsorbed to the sample matrix. The addition of organic solvents to  $\text{CO}_2$  has a slight effect on values of the critical temperature and the critical pressure, so that the temperature and pressure used for pure  $\text{CO}_2$  may require modification.

For environmental analysis, the U.S. EPA has approved several SFE methods; e.g., total petroleum hydrocarbons, polyaromatic hydrocarbons (PAH), and organochlorine pesticides in soils and sludge. SF- $\text{CO}_2$  is also an excellent solvent for fats, making it useful for extractions in the food industry. When high-fat solvent extracts contact reversed-phase HPLC mobile phases, fat can precipitate or strongly sorb to the hydrophobic stationary phase, leading to early column failure. Therefore, SFE can be used as a selective sample preparation technique to remove some of these "column detrimental sample components".

SFE is also used to separate classes of analytes by discrete changes in solvent strength; i.e., density stepping or density programming. The sequential fractionation of hops by density-stepping SFE is one example<sup>12-13</sup>. In the area of polymers, the penetrating power of SF- $\text{CO}_2$  allows the extraction of polymer additives such as anti-oxidants and plasticizers in less than one hour. Such extractions formerly required many hours by Soxhlet or ultrasonic extraction methods. Pharmaceutical chemists have found SFE useful for extraction of drugs from tablet formulations and tissue samples.

## SFE Equipment

**Figure 14.4** is a schematic of a supercritical fluid extractor. The essential parts include a carbon dioxide source, a pump (syringe or cooled-head reciprocating), an extraction chamber (or thimble) in which the sample is placed, a restrictor, and an analyte-collection device (normally a vessel). Temperature is separately controlled for the pump head, the extraction chamber, the restrictor, and the collection device. The  $\text{CO}_2$  is pumped as a liquid and remains so until it reaches the extraction chamber where, under the suitable conditions of temperature and pressure, it becomes an SF. The SF passes through the sample in the extraction thimble for a period of time sufficient to extract the analyte from the solid matrix. Past the thimble, the SF passes through a restrictor where it depressurizes and returns to a non-SF state.



Figure 14.4

## Block Diagram of a Supercritical Fluid Extractor

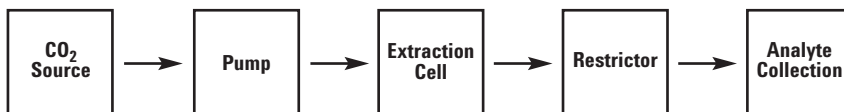

Selection of the restrictor is critical. Two types of restrictors are mainly used: a fixed restrictor consisting of a piece of capillary tubing or a variable restrictor controlled by the user. The restrictor serves to control the supercritical conditions in the thimble, and also controls the precipitation of the analyte as the SF is exposed to atmospheric pressure and the CO<sub>2</sub> dissipates as a gas. The rapid expansion of the SF at this point causes Joule-Thomson cooling, and the restrictor must be heated to compensate for this temperature drop. Otherwise, the restrictor can plug if large quantities of analyte and/or matrix are extracted.

The analyte is collected just beyond the exit end of the restrictor (impinged surface) as an aerosol. Three collection (trapping) methods are used: (a) an empty vessel, (b) a packed trap filled with inert material such as glass or stainless steel beads, SPE-types of packing (20-40 μm), or GC solid packing materials, or (c) dissolution into a solvent. Analyte volatility determines the collection temperature and most favorable method for collection. For example, empty vessels are not well-suited for collecting certain aerosols or high volatility compounds since they may be swept along with the CO<sub>2</sub> gas. Solvent collection methods may also suffer from aerosol formation which may occur when high velocity CO<sub>2</sub> gas passes through the liquid. A solvent should be selected with minimal aerosol formation and with good analyte solubility which helps in more effective trapping. Cooling the solvent can aid in the collection process. Instruments which use a packed trap for collection require a small dispenser pump to rinse analytes into a vial. The ability to trap the analyte is most critical and often the most difficult step in SFE.

## SFE Method Development

In SFE, analytes extract differently from different matrices. For example, different SFE extraction conditions are required for the same PAHs found in soils, fly ash, sludge, and sand. Known analytes trapped within an aged soil sample are more difficult to extract than freshly spiked samples<sup>14</sup>. Three criteria govern SFE extraction from a solid matrix:

- The relative attraction of the analyte to the matrix
- The rate at which analyte moves from the matrix into the extraction solvent
- The solubility of the analyte in the SF

Temperature affects all three of these factors and is an important variable in SFE method development. When high-density SF-CO<sub>2</sub> is unable to effectively extract the analyte of interest from the matrix, the addition of an organic solvent modifier (up to 10% by volume) can facilitate extraction by solubilization of the analyte, competition with the analyte for the surface of the matrix, and/or modification of the matrix for release of the analyte. In the latter case, the modifier may "swell" or solubilize all or part of the matrix to aid penetration of the SF-CO<sub>2</sub>. In extreme cases, chemical reagents such as acetic anhydride for phenols in soil can be added to the SF to react the analyte to a more readily extractable form.

Both polar and non-polar solvents have been used as SF-CO<sub>2</sub> modifiers ("co-solvents"). The same general rules which guide the selection of solvent mixtures for non-SF solvent extraction (Chapter 7) can be applied to SFE as well. That is, both solvent polarity (P') and selectivity are important in affecting analyte recovery and separation from interferences. When selecting the starting conditions for SFE, the properties of the analyte are important: molecular weight, functional groups, polarity, solubility, volatility, pKa, thermal stability, and concentration. Equally important are the matrix characteristics: particle size, homogeneity, porosity, composition, solubility, density, etc. The matrix may also contain its own modifiers such as water, fats, and/or oils. If the desired analyte is polar, matrix water can facilitate the extraction; fats and oils in the sample may have an opposite effect.

The physical form of the matrix is important in SFE. Preliminary sample preparation is usually required for bulk materials (e.g., solid pellets, hard soils, vegetable matter): grinding, sieving, drying, mixing, or wetting. Similar to other extraction techniques, for non-porous or semi-porous materials, a smaller particle size allows for much faster extraction. In some cases, a pH adjustment or addition of solvent into the extraction cell may aid the SFE process. Wet matrices such as sludge may require prior water removal for good recovery and reproducibility. The addition of anhydrous sodium sulfate or diatomaceous earth to the matrix to provide a free-flowing powder is another approach<sup>15</sup>.

The main variables that affect CO<sub>2</sub>-SFE are pressure, temperature, flow rate, co-solvents, and extraction time. Pressure operates in combination with temperature to control the density of the SF. As pressure and density increase, the solvating power of the SF increases. An unlimited number of combinations of temperature and pressure can provide the same extracting SF-CO<sub>2</sub> density (g/mL). For thermally-sensitive compounds, lower temperatures are preferred, while strongly bound analytes may require higher temperatures. High flow rates or long extraction times may be necessary to remove all of the analyte from the extraction thimble. Low flow rates are preferable when the kinetics of the extraction process are slow.

Numerous published methods for matrix/analyte pairs have become available. Often, analysts use "trial-and-error" methods to optimize extraction-collection conditions. To aid method development, **Figure 14.5** provides a generic guide<sup>16</sup>; however, not every sample requires attention to all of these steps. The method development guide assumes that the analyst begins with standard samples investigated in the following order:

- Analytes on an inert matrix (for example, diatomaceous earth, Celite, or filter paper); this allows the SF-solubility of the analyte to be determined.
- Simulated samples on blank matrices (some blank matrices are offered as standards by commercial suppliers); alternatively, a typical "clean" matrix (as close to the actual sample as possible) should be created.
- Simulated samples on real matrices; when developing an SFE method, it is customary to compare the results to "accepted" sample preparation methods such as Soxhlet or liquid-liquid extraction.

Figure 14.5 SFE Method Development Flow Chart

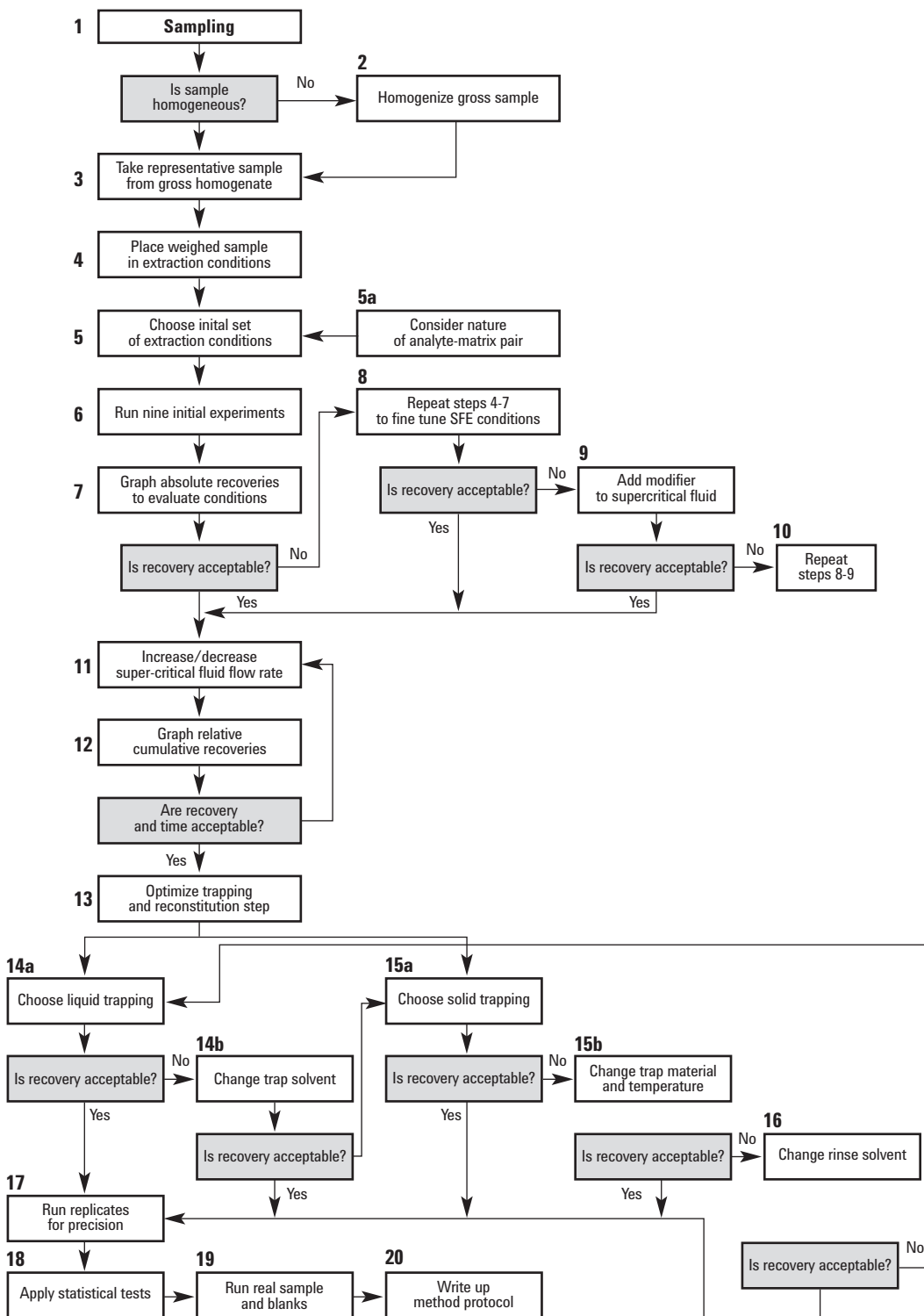

For readers interested in more detail on SFE method development, consult references 14, 15, and 17.

## Microwave-Assisted Solvent Extraction (MAE)

With a microwave source, the sample plus extraction solvent are heated directly, as opposed to conventional heating of the extraction vessel via heat transfer. This is inherently more effective when using hot-solvent extraction. Two limiting forms of MAE are used: (a) a microwave-absorbing (high dielectric constant) extraction solvent or (b) a non-microwave absorbing (low dielectric constant) solvent. In the microwave-absorbing solvent approach, the sample and solvent are placed in a closed non-microwave-absorbing vessel. Microwave radiation heats the solvent to a temperature higher than its boiling point and the hot solvent provides a rapid extraction of analyte under moderate pressure [usually a few hundred psi, although specialized vessels for higher temperatures (up to 300 °C) and pressures (up to 1500 psi) are available]. For these higher pressure extractions, the containers used are made of PTFE, quartz, or advanced composite materials that combine optimum chemical and temperature resistance and good mechanical properties. This approach has been used for the extraction of additives in polymers, vitamins in food, and priority pollutants (PAHs, pesticides, PCBs) in soils and sediments<sup>18-20</sup>.

In the non-microwave absorbing solvent approach<sup>21</sup>, the sample and solvent are placed in an open or closed vessel. The solvent does not become hot, since it absorbs little of the microwave radiation. The sample, which usually contains water or other high-dielectric components, absorbs the microwave radiation and releases the heated analytes into the surrounding liquid, which is selected for good analyte solubility. The latter approach is more “gentle” because it is performed under atmospheric or low pressure conditions and can be used with thermally-labile analytes. Examples of the use of non-microwave absorbing solvents include extractions of lipids from fish<sup>22</sup> and organochlorine pesticides from sediment samples<sup>18</sup>. In a variation of the non-microwave absorbing approach, an inert, solid bar selected for its microwave absorbing properties is placed into the extraction vessel along with the finely divided sample and extraction solvent. The microwave-absorbing bar heats up rapidly thereby transferring the heat energy to the solvent, which in turn extracts analyte from the sample itself as in other liquid-solid extraction approaches. Microwave ovens are also used for acid digestions, especially for trace metals in soils and other difficult matrices, and for protein hydrolysis for amino acid analysis.

MAE uses less solvent than conventional Soxhlet or liquid-liquid extractions. Extraction can be controlled by a number of variables: choice of extraction solvent, heating time, pulsed heating vs. continuous heating, stirring vs. no stirring, closed container vs. open container (pressure), and external cooling of vessel vs. no cooling. In a typical microwave oven, multiple samples (up to 40) can be extracted simultaneously for increased throughput. MAE users are not exposed to the (often toxic) extraction solvents. However, safety precautions should be exercised when dealing with microwave radiation and pressurized closed containers. Additional information can be obtained in these review articles<sup>23-24</sup> and specialized books<sup>17, 26-27</sup>.

## Pressurized Fluid Extraction/Accelerated Solvent Extraction

The extraction vessels can also be heated in a conventional oven instead of using microwave radiation. Pressurized fluid extraction (PFE), also known as enhanced solvent extraction, pressurized liquid extraction, or Accelerated Solvent Extraction (ASE, Thermo Fisher Scientific, Sunnyvale, CA), is performed in a closed extraction vessel and employs common organic solvents at high temperature (50-200 °C) and pressure (150-2000 psi) to extract soluble analytes from solid samples<sup>28-29</sup>. Analyte recovery is enhanced and accelerated by the higher temperatures, and solvent volume is reduced due to the high solute capacity of the heated solvents. The experimental apparatus used in the PFE is similar to that used in SFE – a pump for transporting solvent into and out of the extraction vessel, extraction vessels with an automated sealing mechanism to withstand high pressures, an oven for heating the sample compartment, and collection vials to hold the collected extracts. PFE consists of the following steps: 1) sample cell loading (typical sample sizes 5-20 g); 2) solvent introduction and pressurization; 3) sample cell heating (under constant pressure); 4) static extraction; 5) transfer of extract to sealed vial with fresh vent wash of solid sample; 6) nitrogen purge of cell; and 7) loading of the next sample. Once the sample is loaded into the extraction cell, the entire process is usually automated and time programmable. Instruments are available that provide unattended preparation for up to 24 samples serially and for single or multiple extractions at a time.

Typical environmental applications of PFE includes EPA Method 3545A the extraction of BNA (Bases, Neutrals, and Acids), polycyclic aromatic hydrocarbons (PAHs), organophosphorous and organochlorine pesticides, and polychlorinated biphenyls (PCBs) from solid waste samples. Other applications include unbound fat in food and PCBs in animal tissue.

## Comparison of Methods for Extraction of Solids

**Table 14.2** provides a comparison of the popular methods for the extraction of solids. With the exception of microwave-assisted extractions in open containers and SFE which uses supercritical CO<sub>2</sub>, the extraction solvents used in these techniques are the same. Method development times, recoveries, and reproducibility for these methods are roughly equivalent. The main differences are speed, organic solvent usage, degree of automation, and cost. SFE method development takes longer because of possible matrix effects and lack of a thorough understanding of the effect of co-solvents on analyte extraction. However, optimized SFE methods provide recovery and reproducibility equivalent to these more conventional extraction techniques. Pressurized fluid extraction, modern Soxhlet extraction, and SFE are more automated, compared to MAE. For MAE, sonication, PFE, and some SFE instruments, multiple extractions can take place simultaneously. Both PFE and MAE do not concentrate the extracted analytes since they end up in the volume of the original extraction solvent. SFE using a solid trap with solvent elution will allow for a degree of concentration. PFE sometimes requires that the content of the extraction cell be pumped out with another solvent so that the total extraction volume dilutes the sample more than MAE. However, all of these newer methods save time, labor, and solvents compared to older extraction methods.

Table 14.2

Comparison of Extraction Method for Sample Preparation of Solids							
Parameter	Sonication	Soxhlet (Traditional)	Soxhlet (Modern)	SFE	PSE/ASE	Microwave (CV)	Microwave (OV)
Sample size, g (typical)	20-50	10-20	10-20	5-10	1-30	2-30	2-10
Solvent volume, mL	100-300	200-500	50-100	10-20****	10-45	20-30	20-30
Temperature degrees C	Ambient-40	40-100	40-100	50-150	50-200	50-200	40-100
Pressure	Atmospheric	Atmospheric	Atmospheric	2000-4000 psi	1500-2000 psi	1500-2000 psi	Atmospheric
Time, hr	0.5-1.0	12-24	1-4	0.5-1.0	0.2-0.3	0.1-0.2	0.1-0.2
Degree of automation*	0	0	++	+++	+++	++	++
Number of samples**	1 (serial) High (batch)	1 (serial or batch)	6 (batch)	44 (serial)	24 (serial) 6 (batch)	24 (batch)	6 (serial)
Cost of instrument***	Low	Very low	Moderate	High	High	Moderate	Moderate

CV = closed vessel

OV = open vessel

\* For the most complete commercial instrument, 0 = no automation to +++ = full automation

\*\* Maximum number that can be handled in commercial instruments

\*\*\* Very low < \$1000; low < \$10,000; moderate \$10,000-20,000; high > \$20,000

\*\*\*\* When organic modifier is used to effect "polarity"

## References

---

1. Mangani, F.; Cappiello, A.; Crescentini, G.; Bruner, F.; Bonfanti, L. *Anal. Chem.* **1987**, *59*, 2066-2069.
2. Randall, E.L. *J.A.O.A.C.* **1974**, *57* (5), 1165-1198.
3. Luque-García, J.L.; de Castro, L.J. *Chromatogr. A* **2003**, *998* (1-2), 21-29.
4. Luque-García, J.L.; Ramos, M.J.; Martínez-Bueno, M. J.; Luque de Castro, M.D. *Chromatographia* **2005**, *62* (1-2), 69-74.
5. Luque-García, J.L.; Luque de Castro, M.D. *Anal. Chem.* **2001**, *73* (24), 5903-5908.
6. Soto-Cordoba, S.M.; Baeza, J.; Freer, J. *Bol. Soc. Chil. Quím.* **2001**, *46* (2), 179-185.
7. Levy, J.M. *LCGC* **1999**, *17* (6S), S14-S21.
8. Smith, R.M. *J. Chromatogr. A* **2003**, *1000* (1-2), 3-27.
9. Taylor, L.T. *Techniques in Analytical Chemistry: Supercritical Fluid Extraction*, Wiley, NY, **1996**.
10. Luque De Castro, M.D.; Valcarcel, M.; Tena, M.T. *Analytical Supercritical Fluid Extraction*, Springer, New York, NY, **1994**.
11. Ramsey, E.D. (Ed.). *Analytical Supercritical Fluid Extraction Techniques*, Kluwer Academic Publishers, Dordrecht, Netherlands, **1998**.
12. Caudell, T. *Practical Supercritical Fluid Chromatography and Extraction*, CRC Press, Boca Raton, FL, **1999**.
13. Verschucere, M.; Sandra, P.; David, F. *J. Chromatogr. Sci.* **1992**, *30*, 388-391.
14. Gere, D.R.; Derrico, E.M. *LC/GC Mag.* **1994**, *12*, 432-445.
15. Gere, D.R.; Derrico, E.M. *LC/GC Mag.* **1994**, *12*, 352-366.
16. Majors, R.E. *Sample Preparation Wall Chart, LCGC No. America* **2012**.
17. McHugh, M.; Krukoniš, V. *Supercritical Fluid Extraction: Principles and Practice*, Butterworths, Boston, MA, **1987**.
18. Onuska, F. I.; Terry, K.A. *Chromatographia* **1993**, *36*, 191-194.
19. LeBlanc, G. *Current Trends and Developments in Sample Preparation: Microwave-Accelerated Techniques for Solid Sample Extraction LCGC* **1999**, *17* (6S), S30-S37.
20. LeBlanc, G. *LCGC No. America* **2013**, *31* (11S).
21. Pare, J.R.J.; Belanger, J.M.R.; Stafford, S. *Trends in Anal. Chem.* **1994**, *13* (4), 176-184.
22. Mandal, V.; Mohan, Y.; Hemalatha, S. *Pharmacognosy Reviews Jan-May* **2007**, *1* (1), <http://www.phcogrev.com>
23. Sparr Eskiksson, C.; Bjorklund, E. *J. Chromatogr. A* **2000**, *902* (1-2), 227-250.
24. Tatke, P.; Jaiswal, Y. *Res. J. Med. Plant* **2011**, *5* (1), 21-31.
25. Chemat, F.; Cravotto, G. (Eds.) *Microwave-Assisted Extraction for Bioactive Compounds: Theory and Practice*, Springer; New York, **2013**, ISBN-10: 1461448298 and ISBN-13: 978-1461448297
26. Sin, K. *Microwave-Assisted Extraction of Phenolic Compounds*, LAP LAMBERT Academic Publishing, Germany, **2012**, ISBN-10: 3847331752 and ISBN-13: 978-3847331759
27. Dean, J.R. *Chapter 8, Microwave-Assisted Extraction in Extraction Methods for Environmental Analysis*, Wiley, New York, **1998**, ISBN-10: 0471982873 and ISBN-13: 978-0471982876
28. Richter, B.E.; Ezzell, J.L.; Felix, D.; Roberts, K.A.; Later, D.W. *Amer. Lab.* **1995**, *27* (4), 24-28.
29. Ezzell, J.L.; Richter, B.E.; Felix, W. D.; Black, S.R.; Meikle, J.E. *LC/GC Mag.* **1995**, *13* (5), 390-398.



# Sample Preparation for Biological Samples

In the separation of biomolecules, sample preparation almost always involves the use of one or more pre-treatment techniques. No one sample preparation technique can be applied to all biological samples. The sample preparation approaches used in modern biochromatography are often the same techniques that were used in classical biochemistry, such as dialysis, chemical precipitation, column chromatography, and centrifugation. Currently, there is a growing interest in not only the application of these classical approaches, but also to newer sample preparation technologies in the fields of molecular biology, biotechnology, and the various -omics (e.g. proteomics, genomics, metabolomics, etc.). In these areas, samples are often complex, available in small quantities, and require the utmost care in handling. The requirements for the recovery of biopolymers with structural and functional integrity often demand that the sample preparation be rapid and gentle.

Since most biological samples require separation by HPLC, capillary, or gel electrophoresis, their complex nature necessitates some form of preliminary sample manipulation to achieve better separation results; and, in the case of HPLC to prolong the life of the column. The actual recommended sample preparation technique may depend on a number of variables including the following:

- Molecular weight of sample and interferences
- Sample volume and analyte concentration
- Presence of buffer salt (anion and cations)
- Metal concentration and type
- Presence of detergents
- Presence of particulates
- Presence of antibodies, plasmids, endotoxins, etc.
- Presence of radiolabeled compounds
- Type of analysis to be performed after sample preparation (e.g. chromatography, electrophoresis, mass spectrometry)
- Presence of organics

In addition to filtration for particulate removal, chromatographic (including affinity chromatography) principles can be used to cleanup many biological samples. **Table 15.1** provides a listing of sample preparation techniques that may be used in the flow-through mode using cartridge, disk, or column format. Some of the techniques can be performed in a batch mode where the media is poured into the sample (in a liquid form), allowed to stay in contact usually with agitation, then is removed by filtration or by decanting the liquid phase, leaving behind the compound(s) of interest sorbed onto the stationary phase or contained in the liquid phase. Although slower than the column approach, batch sorption is easier to perform.

Table 15.1

Typical Sample Preparation Techniques in Biochromatography					
Requirement	Most Frequently Used Approaches	Species Retained	Typical Applications*	Packing Matrix-Functional Group	Other Approaches
Antibody Purification	Affinity Chromatography Hydroxylapatite Chromatography	IgG and subclasses	IgG concentration in serum, ascites, and tissue culture media; fluorescent labeled antibodies with unreacted fluorescent tag	Affinity gels (agarose, silica-based) and Hydroxylapatite (calcium phosphate)	
Buffer and Reagent Ultrapurification	Ion Exchange	Trace cations and anions	Removal of ions that cause band broadening or high background in electrophoresis and HPLC detection	Cation and anion exchangers (weak and strong), chelating resins	
	Adsorption	Trace organics	Neutral PS-DVB, alumina, and silica will remove polar organics from buffers; water can be removed from organic solvents	Neutral PS-DVB, alumina, silica	
	Mixed-Bed Ion Exchange	Ions	Deionization of carbohydrates before HPLC; separation of ionic contaminants from proteins; reagent preparation	PS-DVB with quaternary ammonium and sulfonic acid functionalities	Dialysis
			Separation of anions from carbohydrates, dextrans, and polyhydric alcohols	PS-DVB with quaternary ammonium functionality	
		Proteins	Deionization of proteins containing hydrophobic molecules	Mixed resin with dialysis tubing	
Desalting and Buffer Exchange	Ion Exchange	Cations, anions	Desalting amino acids for better TLC and HPLC analysis	Anion and cation exchange resins	Electrodialysis
	Gel Filtration/Size Exclusion	Large molecules are eluted before salts and small molecules	Desalting proteins and nucleic acids with masses >6,000 Da	Aqueous-compatible size-exclusion gels	Dialysis, ultrafiltration
	Ion Retardation	Cations, anions	Removal of salts and ionic detergent from protein and amino acid samples	PS-DVB-acrylate with quaternary ammonium and sulfonic functionalities	
	Reversed-Phase	Hydrophobic analytes	Desalting of polypeptide solutions	C4 or C8 bonded silicas	

(Continued)

## Typical Sample Preparation Techniques in Biochromatography

Requirement	Most Frequently Used Approaches	Species Retained	Typical Applications*	Packing Matrix-Functional Group	Other Approaches
Detergent Removal	Ion Exchange	Cationic and anionic detergents	From proteins, enzyme reactivation	PS-DVB- and polyacrylate-based strong cation exchangers or strong anion exchangers, respectively	Solvent extraction, ion-pair extraction
	Adsorption	Nonionic detergents	Triton X-100 from protein solutions	Silica, hydroxyapatite, reversed-phase, PS-DVB or mixed ion exchange resin to allow nonionic detergent to pass through	Dialysis
	Ion Retardation	Anionic detergents	Excess SDS from samples	PS-DVB-acrylate with quaternary ammonium and sulfonic functionalities	Solvent extraction, ion-pair extraction (with tributyl- or triethyl-amine)
Metal Concentration or Removal	Ion Exchange	Cations	Removal of metals and salts from aqueous medium	PS-DVB or silica-based cation exchanger	Ion exchange membranes
	Chelating Resins	Polyvalent cations	Removal of copper, iron, heavy metals, calcium, and magnesium	Chelating Resins	
	Adsorption	Metal-organic complexes	Metals complexed with polar or hydrophobic complexing agents	Silica, reversed-phase	
Particulate Removal	Filtration	Particulate matter	Pre-treatment to protect HPLC frits and valves; filtration of culture medium	Hydrophobic and hydrophilic membranes (organic-inorganic)	Centrifugation
Plasmid Purification, Probe Cleanup	Gel Filtration/Size Exclusion	Low molecular weight contaminants	Removal of unincorporated radioactive nucleotides from labeling reaction mixture	Agarose, polydextran, and other aqueous-compatible polymeric media	
	Adsorption	Large DNA	Removal of RNA, protein, and other cellular compounds	Agarose, polydextran, and other aqueous-compatible polymeric media	
	Ion Exchange	Ethidium bromide or propidium iodide	Removal from plasmid visualization experiments	PS-DVB with sulfonic functionality	

(Continued)

## Typical Sample Preparation Techniques in Biochromatography

Requirement	Most Frequently Used Approaches	Species Retained	Typical Applications*	Packing Matrix-Functional Group	Other Approaches
Protein Concentration	Ion Exchange	Water	Improve sensitivity of electrophoretic and HPLC analysis	Polyacrylamide resin with dialysis tubing	Lyophilization
		Proteins	Separation of proteins and low molecular weight substances	Hydroxyapatite	Ultrafiltration, chemical precipitation
	Adsorption	Hydrophobic proteins	C18 solid phase extraction to remove hydrophobic proteins from hydrophilic proteins	C18-modified silica	Dialysis
Removal or Concentration of Anions and Cations	Ion Exchange	Cations, anions	Removal of ions from aqueous solutions; concentration of large proteins; removal of mineral acids	PS-DVB with sulfonic functionality (cations); PS-DVB with quaternary ammonium functionality (anions); weakly basic resins (tert-ammonium) (anions)	Ion exchange membranes
Removal or Concentration of Organics	Adsorption	Polar organic	Removal of nonionic detergents and lipids; separation of ethidium bromide from nucleic acid preparations	Alumina, silica, and SPE cartridges with bonded phases	
	Gel Filtration (Organic)/ Size Exclusion/ GPC	High molecular weight compounds are eluted before small molecules	Separation of soluble organic compounds with masses <150,000 Da from complex sample matrices	PS-DVB with various porosities	

The flow-through format is more widely used. Although dilution is a possible consequence, the flow-through column approach is more useful for removing the last traces of the analyte of interest or perhaps impurities of non-interest. Convenient pre-packed cartridges and membrane disks, the latter offering less flow resistance due to their large cross-sectional areas, are readily available from many manufacturers. Sometimes kits are assembled that contain all the media, chemicals, and accessories necessary to perform a cleanup job, especially in the area of obtaining pure DNA, RNA, and mRNA samples. Liquids can be transported through the flow-through devices with applied pressure, vacuum or centrifugation. Many of the sample prep techniques of **Table 15.1** rely on retardation of ionic species using the principles of ion exchange or ion retardation. Others use the principle of hydrophobic interaction and adsorption to retain macromolecules while letting ionic and smaller molecules pass through.

Besides chromatographic principles covered in **Table 15.1**, cleanup of biological samples while maintaining biological activity can be accomplished using other approaches. For example, dialysis is a time-tested process using membranes to cleanup and desalt biological samples. In its classical application (see Chapter 18), dialysis is considered to be a slow technique relative to other sample preparation techniques. Newer approaches such as the use of disposable mini dialysis kits permit the efficient dialysis of small sample volumes. In these devices, the dialysis membrane is conveniently incorporated into the cap that screws onto a conical tube whose bottom maximizes sample recovery.

The use of electro dialysis is a more rapid approach for desalting or buffer exchange. The basis of electro dialysis is the application of a voltage across a stack of ion exchange membranes that carry a fixed positive or negative charge. The cations and anions in the solution migrate into zones of concentration and away from zones of depletion. Electro dialysis is a gentle technique and provides excellent desalting without loss of biological activity of proteins. In addition, transfer of water during the electro dialysis process may result in a slight sample concentration, depending on the amount of current applied.

Ultrafiltration (UF) (see Chapter 18) is a technique that uses centrifugation as the driving force for membrane filtration. Membrane filters with molecular weight cutoffs in the tens of Kdaltons are held in a centrifuge assembly. Upon centrifugation, solvent, salts, and small molecules pass through the membrane while macromolecules larger than the cutoff value are retained and concentrated above the membrane. Because the membranes are selected to show low non-specific adsorption, UF results in good recovery and little loss of biological activity. Two or more cycles may be required to totally desalt a sample.

Many of the sample preparation techniques already covered, such as liquid-liquid extraction (Chapter 7) and membrane extraction (Chapter 18), are directly applicable to the fractionation of biological samples.

Sometimes the combination of two sample preparation approaches results in an overall improvement in cleanup efficiency. For example, the use of chromatographic media combined with dialysis can provide excellent concentration of protein solutions. Insoluble polyacrylamide beads, which have a high affinity for water (1 g of resin can absorb 5 mL of water) and low molecular weight substances, can serve as a concentrator resin. When a dialysis tube or bag containing a dilute protein solution is placed in a beaker containing the resin, the resin develops a high osmotic gradient that pulls the water from the sample through the dialysis membrane, thereby concentrating the protein. The water diffusion rate is about 1-2 mL/h/cm<sup>2</sup> of tubing. Because the resin beads themselves do not diffuse through the dialysis membrane, no interaction with the protein itself occurs.

# Sample Preparation for Nucleic Acid Constituents and Genomics

The modern drug discovery process emphasizes rapid data generation and analysis in order to identify promising new chemical entities very early in the development cycle. Advances in genetics, genomics, biochemistry, and pharmacology have accelerated the changing face of drug discovery. These advances include sequencing of the human genome, improvements in laboratory automation, and advances in the fields of combinatorial chemistry, high-throughput screening, mass spectrometry, and bioinformatics. The end result of all these process improvements includes much faster compound synthesis and more efficient evaluation of the greater number of compounds for pharmacological and metabolic activity. The ultimate goal of modern high-throughput processes, to bring a drug product to market in a shorter timeframe, is already benefiting the scientific and medical communities.

Traditionally, the term “sample preparation” refers to concentration of analyte, exchange of solvent, and/or removal of interfering substances prior to analysis. But in a high-throughput laboratory, automation processes exist for a multitude of supporting functions such as solvent delivery, sample dissolution, sample aspiration and dispensing, sample reformatting from tubes to plates, plate replication, homogenization, handling microplates, applying a vacuum, washing microplate wells, capping/uncapping, sealing, digestion, and delivery of sample to the detection system.

One goal of genomic studies is to reveal new biological targets for drug development by identifying the DNA sequence, which then enables analysis of the genes, the resulting RNA molecules, and/or the proteins. To begin, this task requires the isolation and manipulation of high quality DNA from the sample. Virtually any cell type or virus from any organism may act as a source for nucleic acids, but the process of isolating the DNA may differ, based on the physical attributes of the source cell. Once isolated, the DNA must be made into a ‘library’ containing individual segments that, together, represent each and every nucleotide in that sample genome. Libraries are often made by inserting fragments of sample genomic DNA into larger pieces of DNA from bacteria or yeast that are highly amenable to laboratory manipulation. The manipulated DNA carrying the sample insert can then be grown in a controlled system to increase the yield. For successful genomic sequencing, the subsequent isolation and purification of the DNA constructs is critical and can be time-consuming. The high-throughput of 96-well format DNA sequencers has created the need for rapid methods of sample preparation to keep pace. We will briefly look at sample preparation procedures (both traditional and high-throughput) commonly used for genomic nucleic acids.

# Traditional Nucleic Acid Extraction Techniques

While nucleic acid isolation and purification techniques can vary, they all must accomplish certain objectives. DNA is generally extracted by cell lysis, separated from non-nucleic cellular components such as proteins, lipids and carbohydrates, and finally, a series of precipitation and centrifugation steps isolates the remaining DNA (Figure 15.1). Most protocols also include an RNase digestion to degrade RNA.

Figure 15.1

## Typical Series of Sample Prep Steps for DNA Purification from Bacterial Cells Harboring Plasmids with Inserts

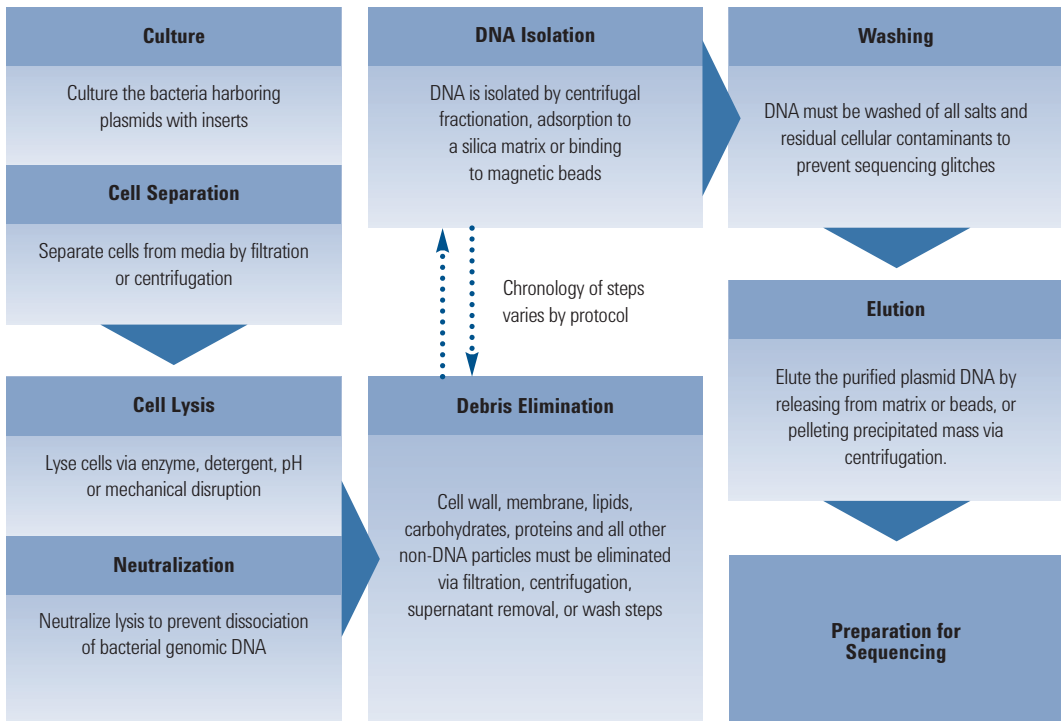

Phenolic extraction of cell lysates is one of the oldest techniques for DNA preparation. Single cells in suspension are lysed with a detergent and a proteinase enzyme to degrade protein molecules. Non-nucleic acid components are then extracted into an organic (phenol/chloroform) solvent, leaving nucleic acids in the aqueous layer. Isopropanol is added to the isolated aqueous phase to precipitate the high molecular weight nucleic acids. Following precipitation, the DNA is separated from the isopropanol by spooling or centrifugation, and is washed twice with ethanol. Most organic extraction procedures incorporate a DNase-free ribonuclease (RNase) incubation step to remove RNA; this step may come before or after the organic extraction. For some applications, a second organic extraction may be necessary to achieve the desired purity of DNA. Organic extractions are not optimal for plasmid isolation, but are more appropriate for whole genomic DNA isolations.

Small amounts (~1 µg from each mL of culture) of bacterial plasmid DNA containing the sample insert sequence are isolated from cell culture using a technique called the "mini-prep." The individual mini-prep procedure provides sufficient DNA for modern capillary and gel-based sequencers and is much less labor-intensive than the standard "maxi-prep," which utilizes a cesium chloride density gradient for isolating milligram amounts of plasmid DNA. Two common methods to lyse cells for mini-prep plasmid isolation are the alkaline hydrolysis method and the rapid boiling procedure. Plasmid DNA can then be separated from cell lysates or other reactants, such as unincorporated nucleotides or linkers, using magnetic particles that have both a high binding efficiency and large capacity for plasmid DNA. These magnetic particle systems work by capturing sequencing extension products and purifying them through a series of successive washes, culminating in a final release step. The isolated plasmid DNA may then be used for automated DNA sequencing and additional molecular biological methods, such as PCR amplification.

Size exclusion chromatography (Chapter 11) is another common technique for efficient and rapid purification of nucleic acids. Gels are available in different porosities that exclude molecules of 10,000-200,000 Da. The purification of nucleic acids from nucleotides or buffers works well using an exclusion size of 25,000 Da, since the average protein size is about 30,000 Da. Disposable, economical, and centrifugeable packed gel filtration columns are ideal for the purification of small volumes (< 100 µL) of nucleic acid solutions and for separating unincorporated radioactive nucleotides from labeling reaction mixtures. The pre-packaged columns, which eliminate the tedious and time-consuming steps involved in manual column preparation, ensure a high recovery of DNA and a high retention of unincorporated nucleotides with minimal labor.

While these various techniques have proven successful for isolating DNA for sequencing of certain genes, operons or plasmids, the advent of whole genome sequencing makes individual sample preparation somewhat obsolete. Even a medium-sized bacterial genome of 2.5 million bases would require more than 20,000 individual sample preparations to achieve 8-fold coverage using a random library. Furthermore, the ability of the sequencing instruments themselves to run in a 96-well plate format necessitates a more rapid plasmid preparation procedure to keep the sequencers running throughout the day and night. As a result, the process of plasmid purification is increasing its speed through the use of automation.



## High-Throughput DNA Purification Systems

Adsorbents that provide fast and efficient DNA purification are the key to making this procedure amenable to automation. Again, the exact nature of the process varies from one manufacturer to the next, but the basic process is uniform: once the cells are lysed using one of the aforementioned techniques, DNA is either adsorbed onto a chemically modified silica matrix contained in 96-well flow-through plates (see **Figure 9.4**), or magnetically separated using magnetic or transient paramagnetic bead technology. RNA, proteins, and other cellular components are filtered out initially or washed free in a subsequent step. The multiple samples of purified DNA are then simultaneously eluted in a purified form that is ready for batch sequencing. The adsorbents are available in pre-packaged 96-well microplate kits and spin tubes from a variety of manufacturers. For example, Agilent Technologies offers several kits for pure genomic DNA and Endotoxin-free Plasmid DNA for Transfection. Various RNA kits are also available such as for pure DNA-free total RNA and highly pure mRNA and miRNA. The silica matrix and magnetic microplate kits offer much greater convenience and higher throughput than the traditional phenol or gel chromatography methods. The kits also improve upon individual mini-prep methods by enabling multiple purifications to be generated simultaneously.

## Automating High-Throughput Systems

Automated liquid handling workstations involve the movement of multiple probes in Cartesian axes (X, Y, Z) over a deck surface configured with labware (e.g., microplates, tube racks, solvent reservoirs, wash bowl, disposable tips). These instruments have proven ideal for aspiration and dispensing of solvents from a source to a destination, and have revolutionized the process of nucleic acid purification with modifications such as control of vacuum manifolds, heating blocks and shakers that utilize 96-well plates. The variable tip spacing feature of multiple probe liquid handlers allows them to expand their tip-to-tip width to aspirate from various test tube sizes, and reduce the tip spacing width when dispensing into wells of a microplate having 9.0 mm well-to-well spacing. As the need arose to move microplates around on the deck, workstation model lines were expanded and the functionality and usefulness of an integrated gripper arm became clearly evident. Labware movement around the deck and into external devices (e.g., microplate stackers, fluorescence readers) is standard.

An example of a modern automated workstation configuration, for rapid isolation and purification of DNA in a Dellaporta-based nucleic acid extraction assay, the Agilent BenchCel Workstation provides complete automation of a variety of genomic sample preparation tasks. At the core of the workstation, the Bravo Liquid Handling Platform performs the addition of reagents for lysis (utilizing Tris-HCl, EDTA, NaCl and 2-mercaptoethanol), followed by precipitation with isopropanol and the removal of contaminants (utilizing phenol, chloroform, isoamylalcohol). The DNA precipitate is then generated using isopropanol followed by an RNAse treatment, another removal of contaminants, and a final isopropanol precipitation.

While the above automation systems are practical and affordable for high-throughput genomics labs, ultra high-throughput laboratories processing more than 5,000 samples per day may need to look beyond these workstation solutions to more custom configurations. The use of magnetic beads allows for the elimination of buffer exchanges and the acceleration of the purification process.

# Sample Preparation for Proteins and Proteomics

A rapidly evolving approach for drug discovery is focused on a detailed understanding of the fundamental biological processes occurring within an organism, specifically the interaction between a genome and its proteome. The term "proteome" refers to the full complement of proteins expressed by the genome. The human genome sequence has been elucidated, as well as that of many other organisms. The interactions between and among the genes, RNA molecules, and proteins in each cell of a functioning organism are highly intricate. Unlike the Human Genome Project, in which the genome is static, the proteome of a cell or tissue is highly dynamic and constantly changes with respect to its surrounding environment, physiological state, stress, drug administration, health, or disease. The Human Proteome Project is faced with the challenge to describe all the proteins expressed by the genome together with their levels throughout the body tissues under various environmental conditions of normal, stressed, and diseased states. Scientists estimate that while there are 20,000-30,000 genes in the human genome, the number of proteins may be from 50,000-500,000. These greater numbers of proteins result from the many post-translational modifications that may occur, such as phosphorylation, acetylation, sulfation, and glycosylation, which result in different protein reactivities. However, simply cataloging proteins is not sufficient because it does not define protein-protein interactions and/or structure-function relationships across different cell types.

There are many more technical challenges for proteomics than for genomics. While polymerase chain reaction (PCR) technology works for DNA, there is no similar method to amplify proteins. Therefore, analytical issues must be solved such as sample preparation, separations of pico- to femto-mole levels of proteins in complex biological matrices, and isolation of the ultra-low level significant proteins. The high sensitivity of the mass spectrometer has enabled the detection of ultra-low levels of proteins, but sample preparation remains vital to remove proteins of high-abundance (e.g., IgG, human serum albumin). Additional tools required for proteomics include protein separation via gels and/or multidimensional liquid chromatography with detection by mass spectrometry, and the utilization of protein databases and bioinformatics. The industrialization of proteomics is requiring partnerships and alliances between commercially available systems and technologies linking fluid transport, consumables, digestions, robotics, detection, and data analysis – all via a common software platform in order for the combined processes to be automatable.

Today, the overall process for proteomics is generally comprised of manual and disjointed steps for sample preparation, protein separation and characterization. There is a real need to develop and implement improved strategies for the high-throughput analysis of protein expression and function in order to quickly realize the tremendous medical advances that are envisioned through successful utilization of the information gained from proteomics. Here, information is provided on current procedures for the sample preparation of proteins, the subsequent steps of protein separation, identification and analysis, and the use and/or need for automated procedures as part of the overall process. We will first look at the classical approaches for protein sample prep and then consider sample prep in proteomics.

## Traditional Protein Sample Preparation Techniques

Sample preparation is used to isolate proteins of interest from biological cells or organisms prior to analysis and is an important step toward achieving accurate, reproducible, and meaningful results. Proteins isolated from these sources contain contaminants such as keratin, albumin, serum proteins, nucleic acids, lipids, carbohydrates, and polysaccharides that are naturally present. In addition, various inorganic salts, buffers, reducing agents, surfactants, detergents, and preservatives may be added to a sample to retain enzymatic or biological activity. The presence of these extraneous materials can cause problems in separations by electrophoresis, e.g., smearing, masking, and poor reproducibility. These materials also affect performance using liquid chromatography techniques with subsequent detection and/or quantitation by mass spectrometry.

No universal sample preparation procedure exists to isolate all proteins in a mixture because proteins are present in multiple forms, are found within different cell locations (e.g., membrane or cytoplasm), and have varying solubilities. Common protein sample preparation processes were briefly outlined in **Table 15.1** include desalting, concentration, centrifugation, dialysis, filtration and ultrafiltration, precipitation and lyophilization. Distinctive characteristics of the protein, such as isoelectric point, molecular weight, shape, solubility and hydrophobicity guide the design of this purification. Since proteins are very fragile, care must be taken in the sample preparation process to avoid the introduction of unwanted modifications that may change conformation and biological activity.

In order to develop a purification strategy, several sample preparation processes are combined (**Figure 15.2**). Typically, a cell lysis procedure is initially performed either by sonication, enzyme treatment or mechanical means to release the proteins. A recent technique entitled pressure cycling technology (PCT) destabilizes molecular interactions by rapidly and repeatedly raising and lowering pressure in the action vessel from atmospheric to levels of up to 45,000 psi. This approach offers an improved way for tissue and cell lysis and to aid in the quantitative recovery of hydrophobic molecules, including integral membrane proteins.

Subsequently, a solubility scheme is used to yield a representative protein sample. Nucleic acids are commonly removed by precipitation techniques or by sonication which breaks them into smaller fragments. Lipids are removed with excess detergent or with precipitation. Each cell or tissue type requires a specific methodology. A compilation of the protocols used to isolate protein from mouse, human tissue, body fluids and microorganisms is available<sup>1</sup>. Following the initial purification into a soluble crude sample, a procedure known as prefractionation can enrich and purify specific protein components prior to separation and analysis. This technique uses various chromatographic and electrophoretic methods<sup>2</sup>.

An important part of the sample preparation process is to remove extraneous proteins present in high-abundance, e.g., albumin, IgG. Albumin is the major acidic protein component in plasma and its removal, along with IgG and a dozen or so of the other major proteins in human and other mammal plasma can enhance the sensitivity of assay techniques and improve the effectiveness and binding capacity of affinity purification media. Classical techniques for removal of the high-abundance proteins usually only deplete one or a few of them (see **Table 15.2**). New affinity-based products can deplete from six to twenty high-medium abundance proteins leaving the thousands of lower abundance proteins in solution for further pre-treatment<sup>3</sup>. These phases consist of antibodies specific for these higher abundance proteins. Both spin tubes and flow-through columns are available. **Figure 15.3** shows the mode of operation of a flow-through column available from Agilent Technologies. Up to 14 high-abundance proteins can be removed using this approach. The plasma sample is injected into the multiple affinity removal system. As depicted in **Figure 15.4**, the high-abundance proteins are retained on the column while the low-abundance proteins pass through the column. They can be trapped/collected on spin columns then concentrated by trace enrichment techniques. The high-abundance proteins are then released by a change of buffer and can be discarded or saved if the need arises. Finally, the column is regenerated and can be used for several hundred injections. A combination of affinity depletion and multidimensional LC-MS/MS has been used to investigate trace levels of up- and down-regulated proteins in biological fluids.

Kits are available to remove DNA, salts and buffers, as well as the isolation and solubilization of specific protein groups (e.g., membrane proteins, acidic and basic proteins, and nuclear proteins). When removing high-abundance proteins from serum, care must be taken to avoid removal of low-abundant proteins and the newer selective removal kits seem to do a good job. Once proteins are purified, some of the common separation methods are single- and two-dimensional electrophoresis (2DE), liquid chromatography (LC), size exclusion chromatography, gel filtration and affinity chromatography.

Other classical laboratory procedures for protein removal are available in texts<sup>4-7</sup>. In contrast to protein chemistry that studies a single component, the focus of proteomics is on the interaction of multiple, distinct proteins and the roles they play as part of a larger system.

Figure 15.2

## Traditional Protein Sample Preparation Processes

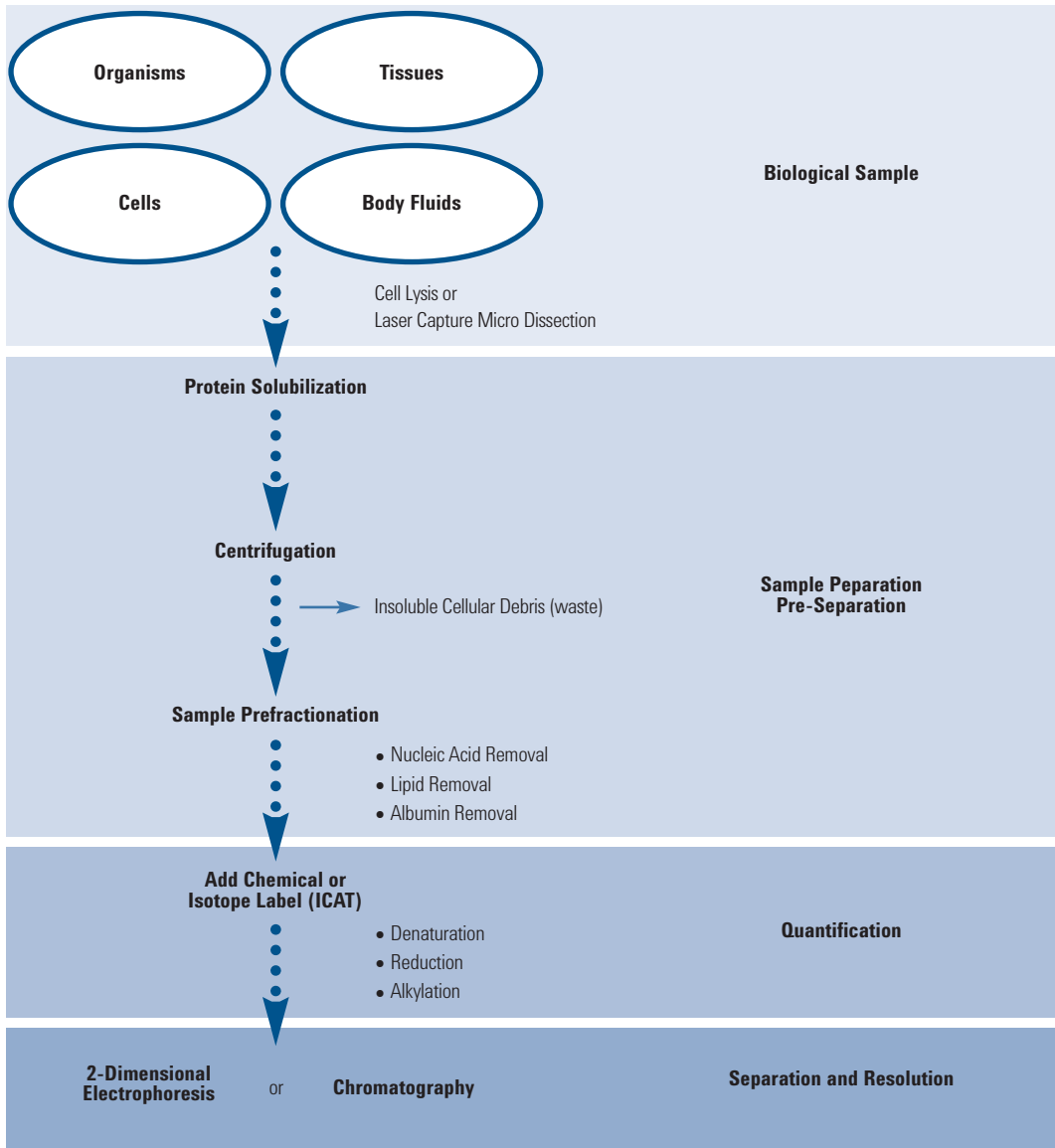

Table 15.2

<b>Classical Methods for Depleting High Abundance Proteins from Biological Fluids</b>				
<b>Technique</b>	<b>Type of System</b>	<b>Designed to Remove</b>	<b>Principle</b>	<b>Reference</b>
Affinity Chromatography	Cibacron Blue or related chlorotriazine dye is bound to chromatographic medium; some phases are proprietary	Albumin	Albumin strongly binds to Cibacron Blue dye that acts as an ionic, hydrophobic, aromatic, or sterically active binding site. Proteins that interact with the gel can be bound or released with a fairly high degree of specificity manipulating the composition of the eluent buffers. Binding capacity: 10-15 mg/mL.	15-19, 47-51
Single Antibody Column	a) Anti-HSA attached to porous polymer b) Anti-IgG attached to porous polymer	a) Albumin b) IgG	a) Antibody specific for HSA b) Antibody specific for IgG	16, 19, 52-53
Protein A-, -G, or -L	The protein bound to resin	Immunoglobulins	There is a strong affinity and selectivity of these proteins for immunoglobulins	16, 54
Combination of Affinity Phases	Multiple phases bound to resin	Albumin and IgG	Combination of above to remove both high-abundant proteins (albumin and IgG) from plasma	16, 20, 55-57
Isoelectric Trapping	Multicompartment electrolyzer or free flow electrophoresis	Albumin, acidic, and basic proteins	In this membrane-based electrophoresis system, proteins are fractionated according to their pI values and end up separated into compartments for easy retrieval. Proteins within a mass range close to that of HSA are excluded. Note that these instruments are designed for protein fractionation but can be used to isolate high-abundance proteins.	58-59

(Continued)

## Classical Methods for Depleting High Abundance Proteins from Biological Fluids

<b>Technique</b>	<b>Type of System</b>	<b>Designed to Remove</b>	<b>Principle</b>	<b>Reference</b>
Gradiflow	Preparative electrophoresis	Albumin	Proteins are fractionated according to their pI value, then further fractionated by size (molecular weight)	60-61
Peptide Affinity Chromatography	Phage isolates coated in 96-well plates		Synthetic peptides chosen from a library were found to bind well to several mammalian serum albumins including a strong affinity for HSA.	62-63
Ion Exchange and Size Exclusion Chromatography	Column switching or in-series	Albumin, IgG, and other proteins	Ion exchange column separates by charge and size exclusion column by molecular weight (size); sometimes reversed-phase chromatography has been used in combination with ion exchange	64-65
Multi-Lectin Affinity Chromatography	Lectins sorbed to agarose beads	Glycoproteins	Multiple mixed lectins have affinity for various glycoproteins and can be used to enrich them from human plasma; can be used in combination with multiple affinity protein depletion columns	66
Organic Solvent Precipitation	Organic solvent is mixed with serum	Proteins larger than 20 KDa	Large proteins will precipitate when a water-miscible organic solvent such as acetonitrile is added to serum; the precipitated proteins can be removed by centrifugation or filtration; the supernatant contains the lower molecular weight proteins for further study.	67-68

Figure 15.3

## Removal of High-Abundant Proteins from Plasma

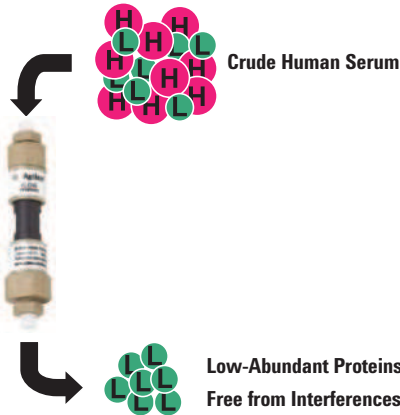

- Column and optimized buffers are used to remove the top 14 most abundant proteins in human serum and plasma samples.
- Attach to HPLC instrument and pump samples through – proteins of interest are collected and analyzed.

- H High-Abundant Proteins**  
(Albumin, IgG, IgA, Transferrin, Haptoglobin, Antitrypsin)
- L Low-Abundant Proteins**  
(Biomarkers for disease and drug targets)

Figure 15.4

## MARS Immunoaffinity Column Elution Profile – 4.6 x 50 mm Column



- **Total column run cycle** = 20 min for injection, elution, and regeneration  
(4.6 x 50 mm column)
- **Capacity** = 15-20  $\mu$ L serum per injection  
1.2-1.6 mg total serum proteins

	Time (min)	%B	Flow rate	Max. Pressure (bar)
1	0.00	0.00	0.250	120
2	9.00	0.00	0.250	120
3	9.01	100.00	1.000	120
4	12.50	100.00	1.000	120
5	12.60	0.00	1.000	120
6	20.00	0.00	1.000	120

### Comparison of Runs #20 and #200

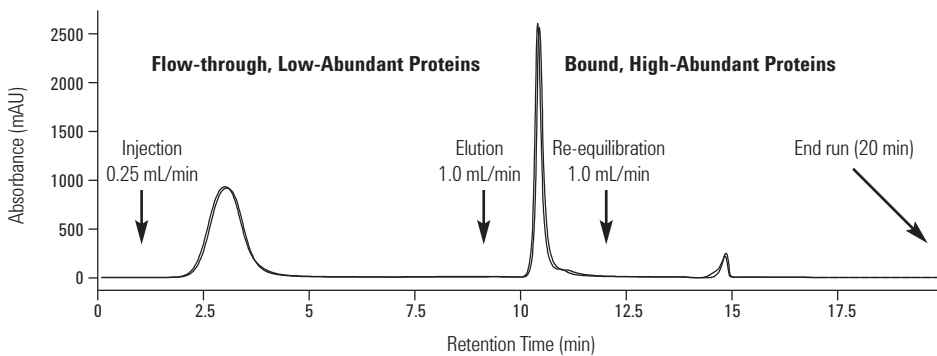



## Modern Approaches of Sample Preparation for Proteomics

The major difference between classical protein chemistry and proteomics is that in classical protein chemistry, interest is focused on isolating an individual protein and identifying its total sequence, whereas in proteomics, the goal is to characterize a complex mixture of proteins present in various expressed levels and identify them using partial sequence analysis (after digestion). This identification would not be possible without databases such as expressed sequence tags (EST), protein and peptide sequences, and powerful data mining algorithms. Agilent's Spectrum Mill MS proteomics software can be used to perform protein database searches of MS/MS data.

Proteomics research is actually separated into three areas: functional, structural and expression proteomics, each having its own set of sample preparation protocols. Expression proteomics is a recognized area of proteomics in drug discovery and pharmaceutical research. It is defined as the identification and quantitation of proteins present in healthy and diseased tissues. Functional proteomics analyzes non-denatured proteins under conditions that keep protein complexes together while structural proteomics aims to elucidate the structures of the functional "active" sites of each human protein. The ultimate goal is to develop drugs which are highly specific for these active sites. The tremendous analytical challenge of proteomics arises from the fact that the proteome is a collection of some 30-80% of gene products expressed at both low levels (10-100 copies per cell) and high levels (10,000-100,000 copies per cell). These numbers represent a dynamic range of at least six orders of magnitude. As a point of reference, most eukaryotic cells contain about 20,000 different proteins having an average molecular weight of 50 kDa. Enzymatic digestion yields about 30 peptides per protein or about 6,000,000 unique peptides. Certainly, these numbers of proteins present colossal technical challenges in terms of their analytical sample throughput, detection and data analysis.

The sample preparation techniques of greatest interest in expression proteomics center on prefractionating and enriching proteins before their separation by preparative electrophoresis or chromatography. Detection is either by matrix-assisted laser desorption ionization (MALDI) or atmospheric pressure ionization (API) mass spectrometry. A typical workflow diagram of the total process for identifying differential protein expression levels is shown in **Figure 15.5**. The classical methods for extracting and isolating proteins as used in protein chemistry are also used in proteomics. In addition, newer methods such as laser capture micro dissection<sup>8-9</sup> increase the differentiation between diseased and healthy tissues. Labeling with stable isotopes (e.g., <sup>13</sup>C, <sup>2</sup>H and <sup>15</sup>N) or isotope coded affinity tags (ICAT) is commonly incorporated in procedures to affinity capture differentially expressed proteins at low-abundance.

## Two-Dimensional Electrophoresis (2DE)

Although considered to be a separation technique rather than a sample preparation technique, 2DE is really a technique for isolating proteins and other biomolecules from complex mixtures by using the principles of multidimensional separation, such as discussed in Chapter 13. For many years, two-dimensional electrophoresis was the standard way to separate proteins in one dimension by isoelectric focusing (IEF) based on isoelectric point and in the second dimension by molecular weight using sodium dodecylsulfate polyacrylamide gel electrophoresis (SDS-PAGE). Even today, many laboratories are still using this time proven approach for protein separation. Visualization of the proteins separated in the gels is done by using inorganic and organic dyes. High resolution 2D imaging and analysis software programs summarize the results and help to identify target proteins for excision and further study. There are several precautions using 2D gels. One important point is that most biologically significant proteins are present at low levels and therefore are generally not detected. Efficient sample preparation techniques can remove the majority of high-abundant interfering proteins (see earlier) and improve reproducibility in 2DE separations. Prefractionation according to a physicochemical parameter such as isoelectric point is performed to enable a higher loading capacity onto gels and minimize protein-protein interactions. It is also important to remove insoluble materials from the sample before running the gel since it is known that hydrophobic membrane proteins or tissue proteins act differently than other proteins. It is critical that the protein be soluble prior to 2DE separation. Various inorganic and organic buffers must be added to disrupt disulfide bonds and noncovalent interactions. A number of companies manufacture 2D gels, sample cleanup kits, reagents, buffers, and organic/inorganic dyes to optimize the separation and isolation of targeted proteins.

### Extraction and Digestion from Gels

In 2DE, the majority of protein is trapped inside the gel and the challenge is to extract it prior to the analysis step. Enzymatic digestion (e.g., trypsin) of excised protein spots involves placing the small gel pieces into a centrifuge tube and performing several steps in sequence: reduction, alkylation, washing, and dehydration. Buffer and enzyme are then introduced and the protein is digested by incubation at 25 °C or 37 °C overnight. Methods to dramatically reduce the time required for enzymatic digestion by using very small sample volumes with an on-line enzymatic digestion technique have been developed. After digestion, several time consuming manual steps to remove the enzyme, buffers, and salts must be completed before the sample is ready for introduction into a mass spectrometer. In-gel digestion kits designed for up to 96 protein samples in 96-well filtration plates are available. These kits include enzymes, reagents, and sample cleanup products that desalt and concentrate protein-digested samples for mass spectrometric analysis.

The procedure of excising protein spots from gels followed by enzymatic digestion presents several opportunities to reduce the loss of low level proteins and increase throughput. Automated robotic and liquid handling workstations that start with a 2D gel, excise the targeted protein spots, digest and concentrate them and, in some cases, spot the final samples onto plates for analysis by mass spectrometry are available. An explanation of how automation, on-line enzymatic digestions and microfluidics are being applied to significantly reduce analysis time is provided in a following section.

## Detection by Mass Spectrometry

The detection method of choice in proteomics is mass spectrometry using MALDI, nano electrospray ionization (ESI) tandem mass spectrometry (MS/MS) or reversed-phase micro capillary LC electrospray ionization. Several reviews discuss details of the use of mass spectrometry in proteomics<sup>10-13</sup>. Initial applications of MALDI and ESI for protein detection utilized purified single proteins and peptides for peptide mass fingerprinting and de novo peptide sequence analysis. However, experiments using biologically significant samples from 2D gels and cell extracts exposed a weakness in the procedure – intolerance to detergents, dyes and organic/inorganic buffers. The ultra high sensitivity of these techniques also makes them more sensitive to the presence of abundant concentrations of protein contaminants such as keratin, Protein A, and albumin.

Aside from quantitation, the detection sensitivity and accuracy of mass measurement of proteins and peptides is also affected by the presence of such contaminants. The challenge faced by mass spectroscopists is to reproducibly remove salt, detergents, lipids, and high-abundant proteins without eliminating biologically significant proteins present in low copy numbers.

Micro columns and micropipette tips packed with stationary phase sorbent materials, like Agilent's OMIX monolithic tips (see Chapter 9) have emerged as cost effective, easy-to-use products for concentrating and desalting protein and peptide samples prior to MALDI analysis. These products have very small dead volumes and can be used with ultra-small sample quantities and contains a small bed of C18, C4, strong cation exchange fixed at the end of a 10  $\mu$ L pipette tip; concentrated, purified samples are eluted in a volume of 1-4  $\mu$ L. The OMIX tips are also available in a 96-well format; a protocol combines in-gel digestion with spotting of the purified and concentrated peptides onto a sample target for analysis by MALDI.

## Multidimensional Liquid Chromatography

Alternatives to electrophoresis and gel technology are sought since the sheer numbers of proteins to be separated and analyzed demand a higher throughput system with greater preparative capacity and reproducibility. Capillary liquid chromatography is a natural choice since it is a proven separation technique and can be fully automated and interfaced with tandem mass spectrometry for on-line detection. This combination is also attractive because the mass spectrometer offers additional resolution by mass to charge ratio beyond the separation achieved on-column. Further explanation of protein separations and interfacing of LC to mass spectrometry is outside the scope of this text.

Multidimensional protein identification technology (MudPIT) uses two chromatography steps interfaced back to back and various configurations are in use: (1) separation on the first column with fraction collection, followed by injection of the collected fractions onto the second dimension column, (2) directly coupled LC columns, and (3) multidimensional LC using column switching (see Chapter 13).

A 2D LC separation typically involves an ion exchange, affinity, size exclusion, or chromatofocusing column coupled with a reversed-phase column in either the first or second dimension. A mixed bed microcapillary column containing ion exchange and reversed-phase moieties on a resin bed is also useful. These chromatographic approaches have been used in place of 2D gels and designed for various analysis protocols, such as: “shotgun” analysis of all proteins (250-5,000 proteins), a single class of proteins (10-250 proteins) and specific protein(s) (1-10 proteins).

The development of “on the fly” acquisition of tandem mass spectra with data-dependent instrument control and chromatographic control has greatly increased throughput of mass spectrometers. Intelligent algorithms provide automated analysis of peptide mass spectra for protein identification. In addition, a comprehensive separation of complex peptide mixtures as well as the resolution of intact proteins can be accomplished.

This approach by LC has the ability to detect low-copy proteins using nano LC-MS/MS and certain classes of proteins which are not easily observed on 2D gels (e.g., large proteins, hydrophobic membrane proteins, and very acidic or very basic proteins); however, the complete resolution of all proteins in a proteome will require the use of more than two dimensions and a prefractionation step.

## Automation of Sample Preparation Processes

The purification of proteins consists of manual and disjointed steps as part of a multi-step process. The automation of these individual procedures is an important goal for proteomics laboratories in order to meet high-throughput demands. The choices for automation, as well as their size, differ in complexity according to the task required. Common options for automation within the overall process outlined in **Figure 15.5** are: the use of laser capture microdissection to isolate healthy from diseased cells; excision of targeted proteins from 2D gels; digestion of these excised gel spots or plugs; desalting and concentration following digestion; and spotting of the peptide samples onto MALDI target plates for analysis.

Automation of these individual steps exists as task-specific modules. The stained spots of interest can be extracted from a gel by specialized instruments with on-board high resolution cameras that acquires an image of the gel, analyzes via software, and generates a protein target excision map; selected proteins are excised via a multiple excision head unit in parallel. Extracted protein plugs can be placed into 96-well (and sometimes 384-well) plates and catalogued. Proteolytic enzymes (e.g., trypsin) are added to the removed pieces of gel and digested with heat. This type of automation module performs all necessary wash steps and digests proteins into peptides. Some systems generally utilize an in-gel digestion kit.

Figure 15.5

## Typical Workflow for Protein Characterization

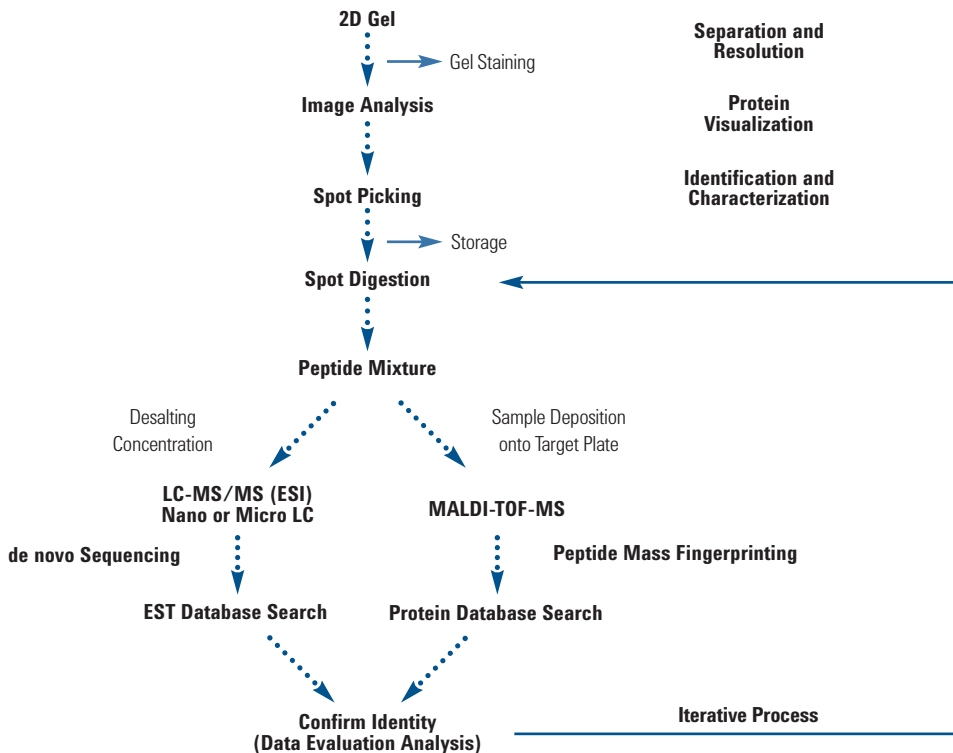

The polypeptide fragments are desalted and concentrated on an automated MALDI preparation station which is essentially a modified liquid handler (1, 4 or 8-channel pipetting), frequently with a robotic arm which shuttles microplates around and in/out of the deck; the basics of liquid handling workstations are covered by Wells<sup>14</sup>. Disposable particle-loaded tips containing solid-phase extraction media, like the OMIX tips from Agilent are commonly used for this sample preparation step and the tips are compatible with most liquid handling workstations. The act of “spotting” places the peptide samples onto specific media called a “MALDI target” and immobilizes them in a suitable matrix for analysis. Workstations can also be used to simply spot target plates with high positional accuracy. Modules are also available that combine two distinct functions, such as protein digestion with MS sample spotting.

Multidimensional LC with MS detection is also amenable to automation by the addition of column switching capabilities with plumbing to accommodate multiple columns in parallel (see Chapter 13). The demand for automated protein processing methods continues as companies are challenged to meet many needs: greater sample throughput, reproducibility, sensitivity for low-abundant proteins, enhanced low volume liquid handling, and high density sample spotting onto target plates.

# Peptide Mapping

Once a protein is separated from its source, it must be further characterized. MS/MS is one technique to identify intact proteins based on their mass spectral characteristics. Peptide mapping is also a very powerful, somewhat selective method, and one of the most widely used identity tests for proteins. It most commonly involves enzymatic digestion (usually using trypsin) of a protein to produce peptide fragments, followed by separation and identification of the fragments allowing the detection and monitoring of single amino acid changes, oxidation, deamidation, and other degradation products. It also enables the direct detection of common monoclonal antibody variants such as N-terminal cyclization, C-terminal lysine processing, and N-glycosylation, as well as other post-translational modifications. A peptide map is a fingerprint of a protein and the end product of several processes that provide a comprehensive understanding of the protein being analyzed. It involves four major steps:

- Isolation and purification of the protein
- Selective cleavage of the peptide bonds
- Chromatographic separation of the peptides
- Validated analysis of the peptides

The first two steps would be considered to be part of the sample preparation process followed by the last two steps of separation and analysis. Reversed-phase liquid chromatography is the preferred technique for determining the progress of the peptide mapping study. Peptide mapping is considered a comparative procedure that confirms the primary structure of the protein and detects alterations in structure. A peptide map should include positive identification of the protein, maximize coverage of the complete peptide sequence, and provide additional information and sequence identification beyond that obtained at the non-digested protein level. A handy "how-to" guide in generating peptide maps is available<sup>69</sup>.

## Protein Digestion

**Table 15.3** shows the five steps in protein digestion that provide selective cleavage of the intact protein. Each of these steps will be examined separately in order to understand the parameters affecting the final outcome of the digestion process.

Table 15.3

Five steps for protein digestion		
Procedure	Intended Effect	General Experiment
1. Sample Preparation	Preparing sample for digestion	Depletion, enrichment, dialysis, desalting
2. Selection of Cleavage Agent	Specific cleavage requirement	None
3. Reduction and Alkylation	Reduction reduces disulphide bonds Alkylation caps SH groups	Reduction: DTT, 45 min, 60 °C Alkylation: IAM, 1 hr, in the dark
4. Digestion Process	Cleavage of proteins	Digestion: pH 8, 37 °C, overnight Quenching: TFA addition
5. Enrichment/Cleanup	Preparing sample for LC or LC/MS analysis	C18 tips, concentrating, dialysis, affinity columns

### Step One: Sample Preparation

Depending on the size or the configuration of the protein, there are different approaches for pre-treatment of your sample. Under certain conditions, it might be necessary to enrich the sample or to separate the protein from added substances and stabilizers used in its preparation, especially if these interfere with the mapping procedure. There are many methods for performing these procedures and each protein has its own set of cleanup measures or processes. Some of the more common approaches used for sample cleanup prior to digestion include depletion/enrichment, dialysis (see Chapter 18), and desalting by gel filtration (see Chapter 11). Some depletion strategies were covered earlier (see **Table 15.2**). These depletion strategies utilize immunoaffinity techniques (e.g., immunoprecipitation, co-immunoprecipitation, and immunoaffinity chromatography). Alternatively, enrichment techniques isolate subclasses of cellular proteins based on unique biochemical activity, post-translational modifications (PTMs), or spatial localization within a cell. Post-translational modifications – such as phosphorylation and glycosylation – can be enriched using affinity ligands such as ion-metal affinity chromatography (IMAC) or immobilized lectins, respectively.

Whether simple or complex, samples often need dialysis or desalting to ensure they are compatible and optimized for digestion. For example, because mass spectrometry (MS) measures charged ions, salts – especially sodium and phosphate salts – should be removed prior to MS to minimize their interference with detection (see Chapter 17). Dialysis and desalting procedures allow buffer exchange, desalting, or small molecule removal to prevent interference with downstream processes.

Dialysis is an established procedure for reducing the salt concentration in samples. It requires filling a dialysis bag (membrane casing of defined porosity), tying the bag off, and placing the bag in a bath of water or buffer where the concentration of salt will equilibrate through diffusion. Large molecules that can't diffuse through the bag remain in the bag. If the bath is in water, the concentration of the small molecules in the bag will decrease slowly until the concentration inside and outside is the same. Once equilibration is complete, the bag is ruptured and the solution poured off into a collection vessel. Dialysis can be used for volumes from microliter up to a few liters, but it is usually not practical for large sample volumes because it can take long times (e.g. hours, even days) for complete salt removal.

To desalt samples prior to digestion, Size Exclusion Chromatography (SEC) (Chapter 11), also known as gel filtration chromatography (GFC), is the most practical laboratory procedure. This method is a non-adsorptive chromatographic technique that separates molecules on the basis of molecular size. Gel filtration allows samples to be processed using isocratic elution. Analytically, GFC can distinguish between molecules (e.g. proteins) with a molecular weight difference of less than a factor of 2. In these applications, the size difference between the substances being separated is very large (i.e. proteins vs. salts). The pore size of the gel filtration media is chosen so that it completely excludes the larger proteins while allowing the smaller molecules to freely diffuse into all of the pore spaces. The column is equilibrated with a buffer, which may be the same or different from that of the sample. The larger molecules – which can't enter the pores of the media – elute first from the column, followed by the smaller molecules that diffuse into the pores. If there is no interest in the smaller molecules and salts, they can be directed to waste, or if these substances are of interest, can be directed to a fraction collector for further handling. If the mobile phase buffer is different from the original sample buffer, the larger molecules will elute in this new buffer; hence the process that takes place is buffer exchange.

## Step Two: Selection of Cleavage Agents

There are two methods employed for the cleavage of peptide bonds, chemical and enzymatic. Chemical cleavage involves the use of nucleophilic non-enzymatic reagents such as cyanogen bromide (CNBr) to chemically cleave the peptide bond at a specific region while proteolytic enzymes, such as trypsin, have been proven highly useful for a variety of site specific cleavage locations. The cleavage method and agent will depend on the protein under test and the specific outcome expectations of the analysis. Additionally, the selection process involves careful examination of the entire peptide mapping process and considerations for related characterizations. The most common cleavage agent used for peptide mapping is trypsin due to its well defined specificity. Trypsin hydrolyzes only the peptide bonds in which the carbonyl group is followed either by an arginine (Arg) or lysine (Lys). Several common cleavage agents and their specificity are shown in **Table 15.4**.

Table 15.4

Cleavage Methods		
Cleavage Type	Cleavage Agent	Specificity
Enzymatic	Trypsin	C-terminal side of Arg and Lys
	Pepsin	Non-specific
	Chymotrypsin	C-terminal side of hydrophobic residues
	Glutamyl endopeptidase	C-terminal side of Glu and Asp
Chemical	Cyanogen bromide	C-terminal side of Met
	Dilute acid	Asp and Pro
	BNPS-skatole	Trp



### Step Three: Denaturation, Reduction, and Alkylation

For the proteolytic enzyme to efficiently cleave the peptide chains, most samples need to be denatured, reduced, and alkylated using various well-known reagents. Denaturation and reduction can often be carried out simultaneously by a combination of heat and a reagent like 1,4-dithiothreitol (DTT), mercaptoethanol, or tris(2-carboxyethyl)phosphine. The most often used chemical is DTT, which is a strong reducing agent that reduces the disulfide bonds and prevents inter- and intra-molecular disulfide formation between cysteines in the protein. By combining denaturation and reduction, renaturation – a problem when using heat solely as the denaturation agent – due to reduction of the disulfide bonds can be avoided. Following protein denaturation and reduction, alkylation of cysteine is necessary to further reduce the potential renaturation. The most commonly used agents for alkylation of protein samples prior to digestion are iodoacetamide (IAM) and iodoacetic acid (IAA).

**Figure 15.6** provides a good example of a reversed-phase chromatographic separation method used to evaluate the reduction and alkylation completeness of a monoclonal antibody prior to digestion.

Figure 15.6

### Reversed-phase Liquid Chromatographic Separation of a Reduced and Alkylated Monoclonal Antibody Prior to Digestion

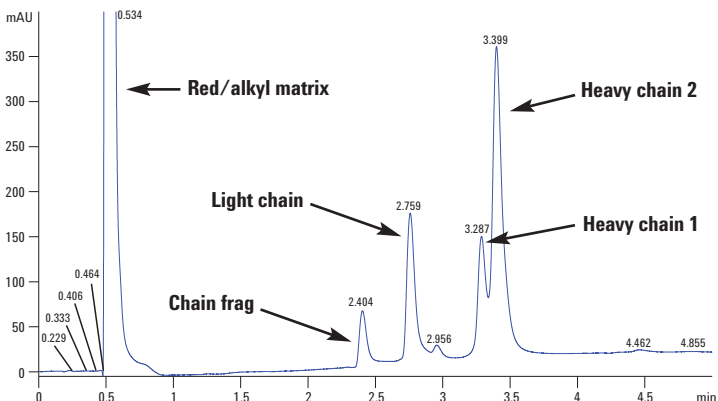

**Conditions:** The separation was performed on an Agilent Rapid Resolution High Definition (RRHD) 300SB-C8, 2.1 x 50 mm column run at 0.5 mL/min, 75 °C, using water (0.1% TFA)/ACN (0.08%) multi-segmented gradient conditions on an Agilent 1290 Infinity LC<sup>69</sup>.

## Step Four: Digestion

As already mentioned, trypsin is the most commonly used protease for digestion due to its well-defined specificity. Since trypsin is also a protein, it may digest itself in a process called autolysis. However,  $\text{Ca}^{++}$ , naturally present in most samples, binds at the  $\text{Ca}^{++}$  binding loop in trypsin and prevents autolysis. With the modified trypsin presently used in most laboratories, autolysis is additionally reduced and not typically a large concern.

Proteins may act differently in different environments and when model proteins were digested in a mixture vs. separately, less effective digestions have been observed. One reason could be increased competition for the trypsin cleavage sites, when more proteins are digested together. Additionally, there can be many factors and conditional parameters that could affect the completeness and effectiveness of digestion of proteins, causing a variety of anticipated outcomes

If these factors are more carefully understood or controlled, the digestion results can be greatly improved. The pH of the reaction, digestion time and temperature, and the amount of cleavage agent used are all critical to the effectiveness of the digestion.

Tryptic digestion is performed at an optimal pH in the range 7.5-8.5, and commonly at 37 °C. To provide an optimal pH for the enzymatic cleavage, a buffer is added [usually 50 mM triethyl ammonium bicarbonate (tABC) or 12.5 mM ammonium bicarbonate (ABC)] prior to the addition of trypsin. A 2-amino-2-hydroxymethylpropane-1,3-diol (Tris) buffer may also be used for this purpose, but it should be taken into consideration that the Tris buffer is incompatible with certain MS analyses, such as MALDI and ESI-MS, and needs to be depleted through solid phase extraction (SPE) or with reversed-phase pipette tips (such as Agilent's OMIX). To ensure a sufficient amount of enzyme is present to perform the digestion, it is crucial to have the right enzyme-to-protein ratio. A more detailed discussion of the critical sub-steps in digestion follows:

- **Digestion pH.** In general, the pH of the digestion mixture is empirically determined to ensure the optimization of the performance of a given cleavage agent. For example, when using cyanogen bromide as a cleavage agent, a highly acidic environment (e.g. pH 2, formic acid) is necessary; however, when using trypsin as a cleavage agent, a slightly alkaline environment (pH 8) is optimal. As a general rule, the pH of the reaction must not alter the chemical integrity of the protein during the digestion or the course of the fragmentation reaction.
- **Digestion Time & Temperature.** Time and temperature play an important role for optimum digestion. To minimize undesirable chemical reactions, a temperature between 25-37 °C is adequate and recommended for most protein digestions (e.g., trypsin digestions are commonly run at 37 °C). However, the type and size of protein will ultimately determine the temperature of the reaction due to possible protein denaturation as the temperature of the reaction increases. Reaction time is also a factor for consideration in optimizing the digestion protocol. If sufficient sample is available, an experimental study should be considered in order to determine the optimum time to obtain a reproducible map while avoiding incomplete digestion. Time of digestion varies from 2-30 h depending on sample size and type, and the reaction is stopped by the addition of an acid, selected so as to not interfere in the map or by freezing.

- **Concentration of Cleaving Enzyme.** The concentration of the cleaving agent should be minimized to avoid its contribution to the map patterns. An excessive amount of cleavage agent is commonly used to accomplish a reasonably rapid digestion time (i.e. 6-20 hours); however, careful consideration should be given to these increased amounts. A protein-to-protease ratio between 10:1 and 200:1 is generally used and it is recommended that the cleavage agent be added in two or more stages to optimize cleavage. In many standard trypsin digestion procedures, the trypsin is added in this manner. Nonetheless, the final reaction volume remains small enough to facilitate separation – the next step in peptide mapping. To sort out digestion artifacts that might interfere with the subsequent analysis, a blank determination is performed using a digestion control with all the reagents, except the test protein.

For further detailed information on the commonly used trypsin digestion method, the reader is referred to Reference 69, which explains the steps, expected digestion times, and a summary of reduction, alkylation and digestion protocols.

## Step Five: Cleanup and Enrichment of Digests

Prior to the actual mapping separation, cleanup and/or enrichment is usually required for the successful analysis of peptide maps. There are many methods to accomplish cleanup and enrichment dependent on sample type and targeted objective. For example, enrichment for specific PTMs (e.g., phosphorylation, ubiquitination, and glycosylation) is performed by affinity purification using PTM-specific antibodies or ligands, while phosphopeptides can be enriched by immunoprecipitation (IP) using anti-phospho-specific antibodies or by pull-down using TiO<sub>2</sub>, that selectively binds phosphorylated serine, tyrosine or threonine.

After peptide enrichment, salts and buffers can be removed using either graphite or C-18 tips or columns, and detergents can be removed using affinity columns or detergent-precipitating reagents. Dilute samples can also be concentrated using concentrators of varying molecular weight cutoff (MWCO) ranges. Once purified, peptide samples are then ready for the final preparation for MS analysis, which varies based on the type of analysis. For LC/MS (or LC-MS/MS) analysis, the proper choice of mobile phases and ion-pairing reagents is required to achieve good LC resolution and analytical results. MALDI-MS requires combining the peptide sample with specific matrices (crystalline energy absorbing dye molecules), which are then dried on MALDI plates prior to analysis.

# Chromatographic Separation for Peptide Mapping

The most widely used peptide mapping chromatographic method is reversed-phase liquid chromatography with low UV (210-220 nm)-, UV (280-nm)- or mass spectrometric-detection. Modern sub-two micron and superficially porous particle columns with C18 bonded phases provide excellent resolving power and the use of volatile mobile phase additives that are compatible with mass spectrometry to allow for rapid separations. The preferred column pore size is 100-120 Angstroms to accommodate a variety of peptide fragment sizes. The column temperature is generally above 40 °C. The most popular mobile phase usually has a pH of less than 3 and consists of 0.1% trifluoroacetic acid (TFA) in water (solvent A) and 0.08% TFA in acetonitrile (solvent B) and linear gradient elution.

Since TFA is an ion pair reagent and sometime causes ion suppression in the mass spectrometer (see Chapter 17), formic acid and acetic acids have also been used, but the chromatography separations may not be as clean as those observed for TFA. Since mass spectrometric detection requires slightly lower flow rates than typically used for 4.6 mm id columns, column id is usually 2.1 mm with lengths up to 150 mm and flow rates generally being less than 0.5 mL/min. As an example of today's HPLC column capability, **Figure 15.7** provides a detailed peptide map of a bovine serum albumin digest in just 20 minutes. For further information on the chromatographic separation conditions, condition optimization and mass spectrometric detection, please consult Reference 69.

Figure 15.7

## Peptide Map of BSA Tryptic Digest on Modern Peptide Mapping Column

2.1 x 150 mm AdvanceBio Peptide Mapping Column (Agilent Technologies)  
Mobile phase: A: water (0.1% TFA), B: ACN (0.08% TFA), 40 °C, Flow: 0.52 mL/min

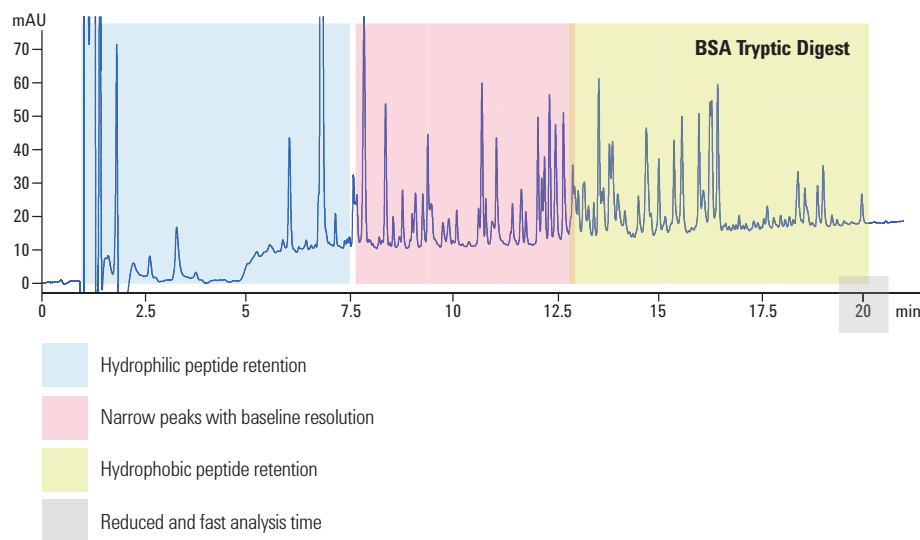

# Automation of Peptide Mapping

Since manual sample preparation of peptides is a time-consuming process and all the steps involved could introduce sample loss and errors into the analysis, total workflow automation may be the preferred route if many samples are to be analyzed by LC-MS/MS. Better reproducibility, increased throughput, rapid method development, decreased reagent and sample volume requirements, and freeing up the time of the scientist are all benefits to miniaturized workflow automation. AssayMAP peptide sample prep solution (Agilent Technologies, Santa Clara, CA) is a miniaturized liquid handling system that has been designed to perform standardized sample preparation workflow. Here, the digestion, cleanup and fractionation (using reversed-phase and/or cation exchange SPE cartridges) steps are based on 96-well plate parallel processing using a modern liquid handling platform (Bravo). Fractionation is off-line to provide increased LC-MS throughput by reducing long LC gradient times.

## References

---

1. Mitra, S. *Sample Preparation Techniques in Analytical Chemistry*, Wiley-Interscience, Hoboken, NJ, **2003**, ISBN #0-471-32845-6.
2. Righetti, P.G.; Castagna, A.; Herbert, B. *Anal. Chem.* **2001**, *73*, 320A-326A.
3. Zolotarjova, N.; Mrozinski, P.; Majors, R.E. *LCGC No. America* **2007**, *25* (2), 118-140.
4. Rehm, H. *Protein Biochemistry and Proteomics* 4th Ed., Academic Press (Elsevier), Burlington, MA, **2006**, ISBN 13: 978-0-12-088546-9 and ISBN 10: 0-12-088545-X.
5. Lovric, J. *Introducing Proteomics: From Concepts to Sample Separation, Mass Spectrometry and Data Analysis*, Wiley, Hoboken, NJ, **2011**, ISBN-10: 0470035242 and ISBN-13: 978-0470035245.
6. Mishra, N.C. *Introduction to Proteomics: Principles and Applications*, Wiley, Hoboken, NJ, **2010**, ISBN-10: 471754021 and ISBN-13: 978-0471754022.
7. Coligan, J.E.; Dunn, B.M.; Ploegh, H.L. et al. *Current Protocols in Protein Science*, John Wiley & Sons, New York, **2002**.
8. Emmert-Buck, M.R.; Bonner, R.F.; Smith, P.D.; Chauqui, R.F.; Zhuang, Z.; Goldstein, S.R.; Weiss, R.A.; Liotta, L.A. *Science* **1996**, *274*, 998-1001.
9. Banks, R.E.; Dunn, M.J.; Forbes, M.A. et al. *Electrophoresis* **2000**, *20*, 689-700.
10. Aebersold, R.; Goodlett, D.R. *Chem. Rev.* **2001**, *101*, 269-295.

(Continued)

## References (Continued)

---

11. Aebersold, R.; Mann, M. *Nature* **2003**, *422*, 198-207.
12. Han, X.; Aslanian, A.; Yates III, J.R. *Curr. Opin. Chem. Biol.* **2008**, *12* (5), 483-490.
13. Bensman, A.; Heck, A.J.; Aebersold, R. *Annual Rev. Biochem.* **2012**, *81*, 379-405.
14. Wells, D.A. *High Throughput Bioanalytical Sample Preparation: Methods and Automation Strategies*, Elsevier Science, San Diego, CA, **2003**, ISBN-10:044451029X and ISBN-13:978-0444510297.
15. Lee, W.-C.; Lee, K.H. *Anal. Biochem.* **2004**, *324*, 1-10.
16. Bjorhall, K.; Miliotis, T.; Davidsson, P. *Proteomics* **2005**, *5*, 307-317.
17. Jacobs, J.M.; Adkins, J.N.; Qian, W.-J.; Shen, Y.; Camp III, D.G.; Smith, R.D. *J. Proteome Res.* **2005**, *4* (4), 1073-1085.
18. Ogata, Y.; Charlesworth, M.C.; Muddiman, D.C. *J. Proteome Res.* **2005**, *4* (3), 837-845.
19. Chromy, B.A.; Gonzales, A.D.; Perkins, J.; Choi, M.W.; Corzett, M.H.; Chang, B.C.; Corzett, C.H.; McCutchen-Maloney, S.L. *J. Proteom. Res.* **2004**, *3*, 1120-1127.
20. Govednik, L.; Brne, P.; Gabor, B.; Barut, M.; Štrancar, A.; Strlič, M. *Chromatographic Characterization of Affinity and Pseudoaffinity Columns for the Depletion of IgG and HSA from Plasma Samples*, 12th International Symposium on Separation Sciences, Poster Paper P1, Lipica, Slovenia, **September 27-29, 2006**.
21. Martosella, J.; Zolotarjova, N.; Liu, H.; Nicol, G.; Boyes, B.E. *J. Proteome Res.* **2005**, *4* (5), 1522-1537.
22. Zhang, K.; Zolotarjova, N.; Nicol, G.; Martosella, J.; Yang, L.-S.; Czafranski, C.; Bailey, J.; Boyes, B. *Agilent Multiple Affinity Removal System for the Depletion of High-Abundant Proteins in Human Serum – A New Technology from Agilent*, Agilent Application Note #5988-9813EN, **2003**.
23. Brand, J.; Haslberger, T.; Zolg, W.; Pestlin, G.; Palme, S. *Proteomics* **2006**, *6*, 3236-3242.
24. Shen, Z.; Want, E.J.; Chen, W.; Keating, W.; Nussbaumer, W.; Moore, R.; Gentle, T.M.; Siuzdak, G. *J. Proteome Res.* **2006**, *5*, 3154-3160.
25. Fang, X.; Huang, L.; Feitelson, J.S.; Zhang, W.-W. *Drug Discovery Today Technol.* **2004**, *1*, 141-148.
26. *Seppro Protein Fractionation Services Brochure*, Genway, San Diego, CA.
27. Lynch, M. *Amer. Biotech. Lab.* **2005**, *37* (5), 24-26.
28. Schuchard, M.; Melm, C.; Crawford, A.; Chapman, H.; Cockrill, S.; Ray, K.; Mehig, R.; Chen, D.; Scott, G. *Specific Depletion of Twenty High Abundance Proteins from Human Plasma*, NCI Proteomic Technologies Reagents Resource Workshop, Chicago, IL, **December 11-12, 2005**.
29. Maccarrone, G.; Milfay, D.; Birg, I.; Rosenhagen, M.; Holsboer, F.; Grimm, R.; Bailey, J.; Zolotarjova, N.; Turck, C.W. *Electrophoresis* **2004**, *25*, 2402-2412.
30. Cho, S.Y.; Lee, E.Y.; Lee, J.S.; Kim, H.Y.; Park, J.M.; Kwon, M.S.; Park, Y.K.; Lee, H.J.; Kang, M.J.; Kim, J.Y.; Yoo, J.S.; Park, S.J.; Cho, J.W.; Kim, H.S.; Paik, Y.K. *Proteomics* **2005**, *5*, 3386-3396.

(Continued)

## References (Continued)

31. Zolotarjova, N.; Martosella, J.; Nicol, G.; Bailey, J.; Boyes, B.E.; Barrett, W.C. *Proteomics* **2005**, *5*, 3304-3313.
32. Moritz, R.L.; Chippingdale, A.B.; Kapp, E.A.; Eddes, J.S.; Ji, H.; Gilbert, S.; Connolly, L.M.; Simpson, R.J. *Proteomics* **2005**, *5*, 3402-3413.
33. Yocum, A.K.; Yu, K.; Oe, T.; Blair, I.A. *J. Proteome Res.* **2005**, *4* (5), 1722-1731.
34. Wu, J.; Kobayashi, M.; Sousa, E.A.; Liu, W.; Cai, J.; Goldman, S.J.; Dorner, A.J.; Projan, S.J.; Kavuru, M.S.; Qiu, Y.; Thomassen, M.J. *Mol. Cell. Proteomics* **2005**, *4*, 1251-1264.
35. Wang, H.; Clouthier, S.G.; Galchev, V.; Misek, D.E.; Duffner, U.; Min, C.-K.; Zhao, R.; Tra, J.; Omenn, G.S.; M. Ferrara, J.L.; Hanash, S.M.; *Mol. Cell. Proteomics* **2005**, *4*, 618-625.
36. Molina, H.; Bukenborg, J.; Reddy, G.H.; Muthusamy, B.; Scheel, P.J.; Pandey, A. *Mol. Cell. Proteomics* **2005**, *4*, 637-650.
37. Echan, L.A.; Tang, H.-Y.; Ali-Khan, N.; Lee, K.; Speicher, D.W. *Proteomics* **2005**, *5*, 3292-3303.
38. Tang, H.-Y. *Proteomics* **2005**, *5*, 3329-3342.
39. Zolotarjova, N.; Boyes, B.; Martosella, J.; Yang, L.-S.; Nicol, G.; Zhang, K.; Czafranski, C.; Bailey, J.; Smejkal, G.B., Ed.; Lazarev, A., Ed. *Separation Methods in Proteomics*, CRC Press, Boca Raton, FL, **2005**. ISBN-10: 0824726995 and ISBN-13: 978-0824726997.
40. Anderson, L.; Hunter, C.L. *Mol. Cell. Proteomics* **2006**, *5*, 573-588.
41. Sitnikov, D.; Chan, D.; Thibaudeau, E.; Pinard, M.; Hunter, J.M. *J. Chromatogr. B* **2006**, *832*, 41-46.
42. Misek, D.E.; Kuick, R.; Wang, H.; Galchev, V.; Deng, B.; Zhao, R.; Tra, J.; Pisano, M.; Amunugama, R.; Allen, D.; Walker, A.K.; Strahler, J.R.; Andrews, P.; Omenn, G.S.; Hanash, S.M. *Proteomics* **2005**, *5*, 3343-3352.
43. He, P. et al. *Proteomics* **2005**, *5*, 3442-3452.
44. Huang, L.; Harvie, G.; Fietelson, J.S.; Gramatikoff, K.; Herold, D.A.; Allen, D.L.; Amunngama, R.; Hagler, R.A.; Pisano, M.R.; Zhang, W.W.; Fang, X. *Proteomics* **2005**, *5*, 3314-3328.
45. Liu, T.; Qian, W.-J.; Mottaz, H.M.; Gritsenko, M.A.; Norbeck, A.D.; Moore, R.J.; Purvine, S.O.; Camp, D.G.; Smith, R.D. *Mol. Cell. Proteomics* **2006** EPUB.
46. Schuchard, M.D.; Melm, C.D.; Crawford, A.S.; Chapman, H.A.; Cockrill, S.L.; Ray, K.B.; Mehig, R.J.; Kappel, W.K.; Scot, G.B. *Origins* **2005**, *21*, 17-23.
47. Wang, Y.Y.; Cheng, P.; Chan, D.W. *Proteomics* **2003**, *3*, 243-248.
48. Ahmed, N.; Barker, G.; Oliva, K.; Garfin, D.; Talmadge, K.; Georgiou, H.; Quinn, M.; Rice, G. *Proteomics* **2003**, *3*, 1980-1987.
49. Colantonio, D.A.; Dunkinson, C.; Bovenkamp, D.E.; van Eyk, J.E. *Proteomics* **2005**, *5*, 3831-3835.
50. Ramstrom, M.; Hagman, C.; Mitchell, J.K.; Derrick, P.J.; Hakansson, P.; Bergquist, J. J. *Proteome Res.* **2005**, *4*, 410-416.

(Continued)

## References (Continued)

---

51. Hinerfeld, D.; Innamorati, D.; Pirro, J.; Tam, S.W. *J. Biomolec. Techniques* **2004**, *15* (3), 184-190.
52. Affibody Application Note, *Depletion of Abundant HSA from Serum*, Bromma, Sweden
53. Greenough, C.; Jenkins, R.E.; Kitteringham, N.R.; Pirmohamed, M.; Park, B.K.; Pennington, S.R. *Proteomics* **2004**, *4*, 3107-3111.
54. Fahnestock, S. Trends in *Biochem. Sci.* **1987**, *5*, 1567.
55. Fountoulakis, M.; Juranville, J.-F.; Jiang, L.; Avila, D.; Roder, D.; Jakob, P.; Berndt, P.; Evers, S.; Langen, H. *Amino Acids* **2004**, *27*, 249-259.
56. Shen, Y.; Kim, J.; Strittmatter, E.F.; Jacobs, J.M.; Camp III, D.G.; Fang, R.; Tolie, N.; Moore, R.J.; Smith, R.D. *Proteomics* **2005**, *5*, 4034-4045.
57. Govorukhina, N.I.; Keizer-Gunnink, A.; van der Zee, A.G.J.; de Jong, S.; de Bruijn, H.W.A.; Bischoff, R. *J. Chromatogr. A* **2003**, *1009*, 171-178.
58. Herbert, B.; Righetti, P.G. *Electrophoresis* **2000**, *21*, 3639-3648.
59. Mikios, G.L.; Maleszka, R. *Proteomics* **2001**, *1*, 30-41.
60. Rothmund, D.L.; Locke, V.L.; Liew, A.; Thomas, T.M.; Wasinger, V.; Rylatt, D.B. *Proteomics* **2003**, *3*, 279-287.
61. Lee, H.-J.; Lee, E.-Y.; Kwon, M.-S.; Paik, Y.-K. *Current Opinion in Chemical Biology* **2005**, *10*, 1-8.
62. Sato, A.K.; Sexton, D.J.; Morganelli, L.A.; Cohen, E.H.; Wu, Q.-L.; Conley, G.P.; Streltsova, Z.; Lee, S.W.; Devlin, M.; DeOliveira, D.B.; Enright, J.; Kent, R.B.; Wescott, C.R.; Ransohoff, T.C.; Ley, A.C.; Ladner, R.C. *Biotechnol. Prog.* **2002**, *18*, 182-192.
63. Baussant, T.; Bougueleret, L.; Johnson, A.; Rogers, J.; Menin, L.; Hall, M.; Aberg, P.-M.; Rose, K. *Proteomics* **2005**, *5*, 973-977.
64. Petric, T.C.; Brne, P.; Gabor, B.; Govednik, L.; Barut, M.; Strancar, A.; Kralj, L.Z. *J. Pharm. Biomed. Anal.*, (in press).
65. Jin, W.-H.; Dai, J.; Li, S.-J.; Xia, Q.-C.; Zou, H.-F.; Zeng, R.J. *Proteome Res.* **2005**, *4*, 613-619.
66. Yang, Z.; Hancock, W.S. *J. Chromatogr. A* **2004**, *1053* (1-2), 79-88.
67. Alpert, A.J.; Shukla, A.K. ABRF 2003, poster #P111-W.
68. Zhang, J.; Goodlet, D.R.; Peskind, E.R.; Quinn, J.F.; Zhou, Y.; Wang, Q.; Pan, C.; Yi, E.; Eng, J.; Aebersold, R.H.; Montine, T.J.; J. *Neurobiol. Aging* **2005**, *26*, 207-227.
69. *Keys for Enabling Optimum Peptide Characterizations: A Peptide Mapping "How to" Guide*, Agilent Technologies, Santa Clara, CA, Publication Number 5991-2348EN, **2013**.



# Sample Preparation in Bioanalysis

Analysis of drugs, their metabolites and low molecular weight biomarkers in biological matrices such as plasma, serum, whole blood, urine, saliva, tissues, etc., is commonly termed 'bioanalysis'. Here, we will also consider the analysis of tissue samples as part of bioanalysis since tissue sample preparation is a key part of pharmaceutical and biological research. We will refer to the sample preparation of biological samples for high molecular weight constituents (e.g. protein, nucleic acids, etc.) as biological sample preparation (see Chapter 15). Bioanalysis is an important part of the overall drug development process starting with in vitro/in situ testing, preclinical studies through to clinical studies. The last decade has witnessed many technological breakthroughs in analytical methodology and instrumentation. Apart from improved selectivity and sensitivity, modern analytical instrumentation has provided an edge to fast and cost-effective bioanalytical method development and validation. Among these modern analytical techniques, liquid chromatography coupled with mass spectrometry is considered to be the benchmark for quantitative/qualitative bioanalysis, imparting specificity, sensitivity, and speed. However, this most selective and sensitive analytical technique also suffers from limitations such as matrix effects, compromised selectivity, and a fall in sensitivity of the analyte of interest in the processed biological matrix.

Sample preparation, also known as sample pre-treatment/sample cleanup/sample extraction, is an integral part of most bioanalytical methods. In a clinical situation, the drug/metabolite/biomarker of interest is present in biological matrix, which has a complex biochemical nature and comprises numerous components (e.g. salts, acids, bases, proteins, cells, exogenous/endogenous small organic molecules like lipids and lipoproteins). However, the biochemical complexity of the matrix may differ (e.g. tissue, whole blood, plasma/serum, urine, saliva, cerebral spinal fluid, etc.). In simple terms, sample preparation is a process which aims at selective isolation of the analyte of interest from the matrix, minimization/elimination of matrix components in the processed sample and, if required, concentration of the analyte of interest. Effective sample preparation is a skill and accounts for up to 80% of the total bioanalysis time. As mentioned in Chapter 1, sample preparation is the most labor-intensive and error-prone process in overall bioanalytical methodology.

Many of the sample preparation protocols covered throughout this book are directly applicable to bioanalytical matrices. Traditionally, liquid-liquid extraction (LLE, Chapter 7), filtration (Chapter 5), solid-phase extraction (SPE, Chapters 9 and 10), and “dilute and shoot” have been used as sample preparation techniques. Information on those techniques will not be repeated since they were already covered in detail. However, new and improved sample preparation technologies are being developed constantly and more effective ways of extracting the analyte from the biomatrix have become available. Many of these newly developed sample preparation techniques have been tested, validated, and commercialized. This chapter will provide a brief coverage of some of the newer or more widely used approaches.

## Blood Analysis in Bioanalytical Laboratories

Blood analysis is certainly the most popular matrix for the analysis of drugs and drug metabolites in biological fluids. Most often blood plasma or serum is the favored matrix for analysis, but often large blood volumes must be collected. In pharmacokinetic (PK) and toxicokinetic (TK) studies, rodents are the most used animals for preclinical testing. Small rodents such as mice have a limited blood supply. Typically, samples of between 200-250  $\mu\text{L}$  (total volume up to 1500  $\mu\text{L}$ ) is needed per TK testing. In order to obtain a sufficient supply of blood sample, the animal must be warmed for 10 min prior to sampling. Often, several rats or mice must be pooled in order to obtain enough blood for testing. Clearly, using less blood for these tests would save on animal usage. In clinical testing for neonatal humans, a large amount of blood is never available. Thus, using a reduced volume of blood would enable more pediatric studies for metabolic and other testing.

The question often arises: whether to use plasma or whole blood for analytical measurements? Some studies have shown that a number of drugs tend to distribute evenly between plasma and blood cells while other studies show that some drugs bind selectively to plasma proteins. Reports have also shown that drugs such as immunosuppressants bind predominantly to blood cells. Conventionally, plasma has been used for drug metabolism (DM) and PK/TK studies because of its ease of handling, shipping and storage, compared to whole blood. However, it is noted by regulatory authorities in both the International Conference on Harmonization and the United States Food and Drug Administration that blood is an acceptable biological matrix for measurement of drug exposures. So in some cases, the use of whole blood for analysis in DMPK and TK studies could be preferable.

## Traditional Whole Blood Analysis

**Figure 16.1** depicts the various ways to analyze and process whole blood. Traditional approaches are shown in the middle of the figure. These are dialysis, liquid-liquid extraction, protein precipitation, (hemo)lysis, membrane filtration, and anti-coagulation. Such approaches generally require larger volumes of blood and multiple, time-consuming steps where analyte losses may occur. Many of the traditional methods are performed manually, but obviously when faced with large numbers of samples, automation via robotics or other approaches may be warranted. All of these approaches end up with a matrix-depleted (pre-processed) sample. Depending on the final analytical technique used for measurement of drugs and metabolites, some additional sample preparation, such as solid phase extraction (SPE) may be required for final cleanup and preconcentration. In recent years, LC-MS/MS has been used for further separation and detection. The heightened sensitivity and selectivity of this hyphenated method has been a boon to trace analysis. In fact, in many fields, this combination has become the norm for trace analysis. Using LC-MS/MS, one can often determine parts per billion in biological samples, even without extensive sample cleanup. For quantitative analysis, LC-MS/MS is a must.

Figure 16.1

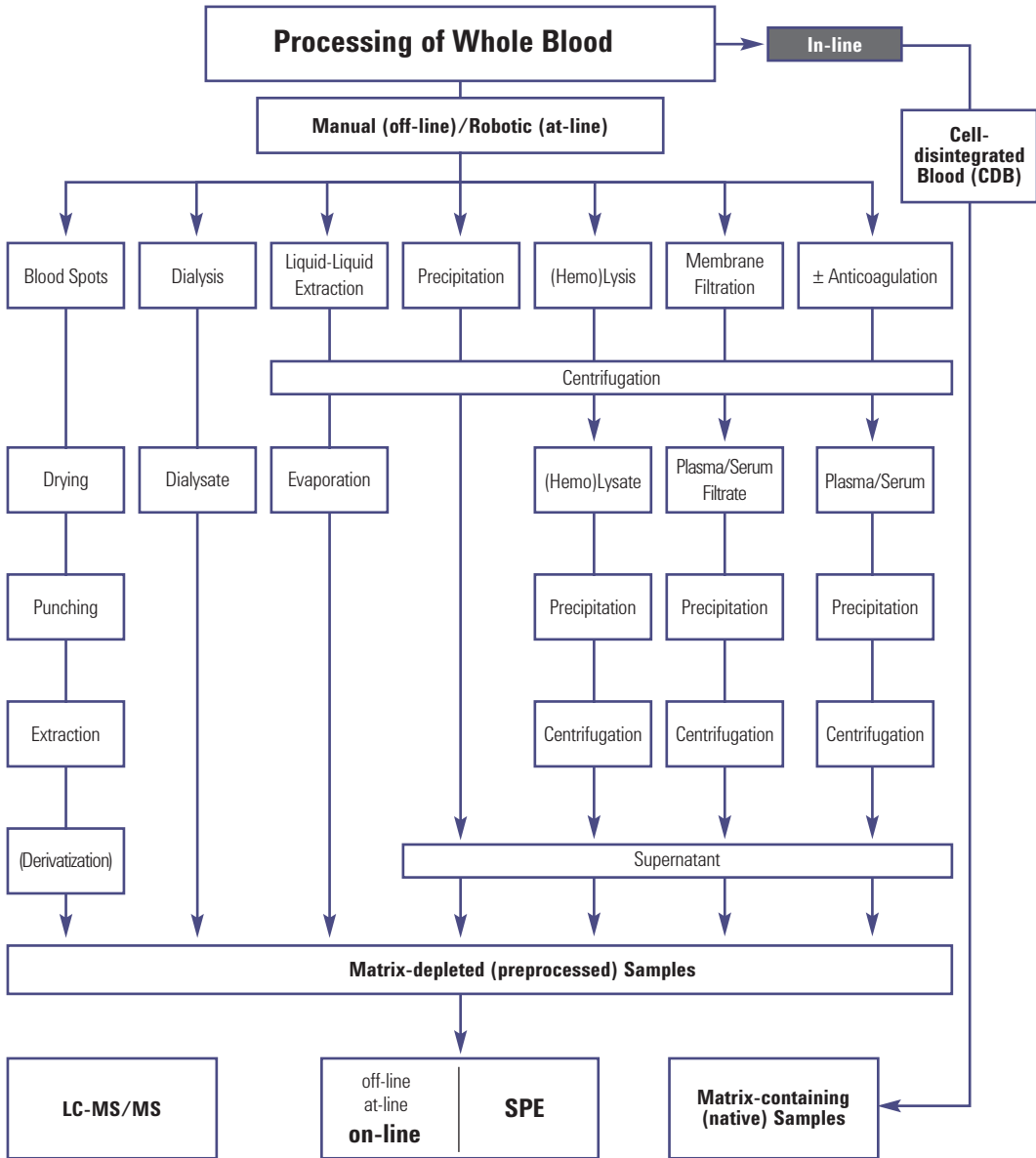

Adapted from Reference 1.

However, these traditional techniques for whole blood analysis still do not meet the needs for small volumes of whole blood samples. A recent technology that uses a much lower amount of blood sample than previously considered, known as Dried Blood Spot (DBS) analysis (**Figure 16.2, A-D**), has drawn a great deal of attention. The technique has been expanded to other biological fluids [e.g. plasma, saliva, cerebral spinal fluid (CSF)], so the term Dried Media Spot (DMS) analysis has been proposed. An interesting new approach to whole blood sample preparation is the development of cell-disintegrated blood (CDB, **Figure 16.2E**). In this approach, a sample of homogenized blood is passed through a heated (75 °C) stainless steel capillary. The resulting heat shock induces cell disintegration and generates a novel matrix known as CDB which can be further analyzed. For more information on this technique, please refer to references 1-3.

**Figure 16.2**  
**Steps in Dried Blood Spotting**

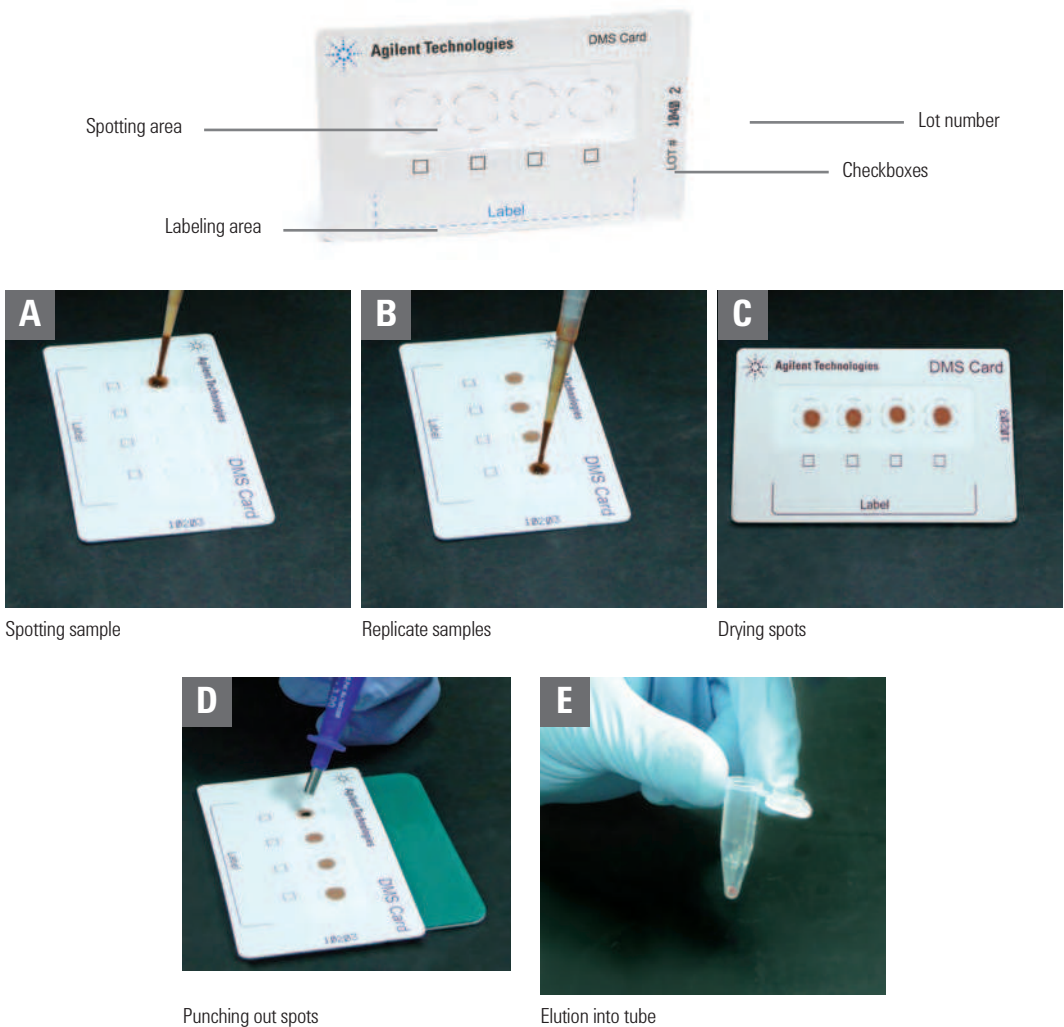

# Dried Blood Spot Analysis/ Dried Media Spot Analysis

The use of DBS analysis was already described in 1913 by Bang<sup>4</sup> in the estimation of blood glucose concentration. However, the most prominent use of dried blood spots dates to the early 1960s when Dr. Robert Guthrie developed an assay for the detection of phenylketonuria<sup>5</sup>. His application of collecting blood on filter paper led to the population screening of newborns for the detection of inherited metabolic diseases. In recent years, the collection of blood on filter paper has become a significant tool for screening individuals for clinical purposes, animal testing for preclinical purposes, therapeutic and illicit drug monitoring, and the potential application to routine drug development.

Today, pressures in the pharmaceutical industry to deliver high-quality PK data in the shortest possible timeframe is requiring workers in the field to accurately and precisely collect, share, store and analyze thousands of biological samples. In addition, the movement to reduce, refine and replace the use of animals in drug development is causing challenges to collect adequate samples while remaining within acceptable total blood collection volumes and avoiding excess animal usage. Thus, dried blood spot analysis is a way to address these challenges in the pharmaceutical industry. In addition, the use of techniques picked up in performing dried blood spot analysis is extending this approach to other fields.

As shown in the workflow of **Figure 16.2**, DBS handling and analysis is fairly simple and involves only a few steps. A finger or a heel prick followed by blood flow into a glass capillary is the usual method of collection (although sometimes a pipette tip is utilized). For animal studies, a tail prick is preferred. Thus, use of a syringe for venous blood drawing is not required. Depending on the size of the capillary, a sufficient amount of blood is drawn to allow multiple spottings. Usually, only a few tens of microliters are needed. Blood is sometimes collected from the subject in a microvessel.

A DBS card with a defined size is constructed of filter paper or other non-cellulose material such as the Agilent DMS Card. This card is used as the device for sample spotting. As shown in **Figure 16.2A**, after collection, the blood is spotted onto the DBS card. A typical card allows the application of up to four blood spots (**Figure 16.2B**). Typically 10-30  $\mu\text{L}$  (average size: 15  $\mu\text{L}$ ) of blood are applied for each spot. The blood is delivered by the capillary (or sometimes a micropipette). It is of utmost importance not to allow the capillary to touch the filter paper to prevent contamination. A typical blood spot is in the range of 5-9 mm in diameter. Next, the blood spots are allowed to dry for a period of two hours at room temperature (**Figure 16.2C**). Drying racks are available for this purpose. When the blood is treated in this manner, it can be stored for long periods of time at room temperature without degradation. To ship or store loaded cards, they should be placed in sealable, plastic bags containing a desiccant.

For analysis, a circular portion (disk) of each dried blood spot is punched out (**Figure 16.2D**) into a vial, centrifuge tube, or well of a 96-well plate. A typical punch size is a 3-6 mm disk, which can be optimized based on the required limit of detection and available spotted blood volume. With a trained technician, manual punch times are typically 10-15 min. for 96 samples. An organic solvent, typically methanol or methanol-water mixtures containing an internal standard is used to elute the analytes of interest. For basic analytes 0.1% formic acid in 80:20 (v/v) methanol:water and for acidic analytes a solution of 1% ammonium hydroxide in 60:40 (v/v) is recommended. Extraction solvent volumes are in the range of a few hundred microliters, typically 300  $\mu\text{L}$ . Studies have shown that using the DBS technique, spot sample sizes are usually reproducible to  $\pm 5-10\%$ <sup>6</sup>. In some instances, further sample cleanup may be required using protein precipitation, liquid-liquid extraction, or solid phase extraction.

**Table 16.1** shows the many advantages of the DBS technique compared to conventional plasma analysis. A disadvantage of the DBS analytical technique is that it is not a preconcentration technique and thus often requires a highly sensitive analytical technique (e.g. LC-MS/MS) that may be beyond the capabilities of some laboratories. However, LC-MS/MS is becoming the standard analytical technique for all sorts of trace analysis. Presumably, using micro-SPE, some additional cleanup of the matrix-depleted DBS extract could be undertaken. Other considerations are that the technique cannot be used for volatile and air-sensitive compounds and certain unstable metabolites. Photosensitive compounds may require special handling.

Table 16.1

<b>Comparison of Conventional Plasma Analysis and Dried Blood Spot Analysis</b>			
<b>Parameter</b>	<b>Conventional plasma analysis</b>	<b>Dried blood spot analysis</b>	<b>Comments for DBS</b>
Blood volume	>500 $\mu$ L	10-30 $\mu$ L	Fewer experimental animals required; more consistent data obtained through more serial sampling from individual animals and less reliance on composite data; neonatal and juvenile patients can be studied
Blood collection technique	Venous cannula withdrawal using syringe	Finger or heel prick using capillary	Less invasive sampling and patient discomfort and easier for multiple samples; overall easier sample collection
Sample processing	Centrifugation, isolation and cleanup of plasma	Simple three-step procedure; on-substrate cleanup has the potential to convey greater analyte stability, especially for enzyme-sensitive compounds	Fewer steps involved for DBS and therefore less chance of error; less labor involved; not easily automated presently; usually manual punching and extraction
Storage and transportation	Plasma must be stored and shipped under frozen conditions	Room temperature stability in dry state; can be shipped without biohazard labeling	DBS samples can be stored at room temperature and shipped without dry ice for more remote sampling, particularly important in human clinical trial samples
Cost	Requires freezer, dry ice for shipment, more animal use, treatment as hazardous material	Reduced shipping costs, storage costs, fewer test animals required, non-hazardous shipment requirements.	Can lower overall cost of drug development



The DBS sample collection technology has been validated for a number of pharmaceutical compounds and numerous studies have shown good correlation between DBS results and those of conventional blood plasma analysis methods. For example, one study showed a direct comparison of conventional blood analysis techniques versus blood spotting techniques for the quantitation of 12 pharmaceutical compounds tested in vivo in rats<sup>7</sup>. Overall, an excellent correlation was achieved between DBS and blood:water samples. Another example where toxicokinetic studies for the drug Omeprazole was performed in vivo in rats and the results in whole blood and plasma was compared to DBS<sup>8</sup>. For the conventional plasma analysis 240  $\mu\text{L}$  of blood was used but only 60  $\mu\text{L}$  was required for the classic DBS card (4 spottings). The analysis of drug eluted from the DBS card was performed by LC-MS/MS. The ratio of blood to plasma concentrations was calculated by the average of the DBS blood concentration to plasma concentration and predicted blood concentrations were obtained by applying this ratio to the plasma concentrations.

Because large numbers of samples encountered in DMPK/TK studies, manual loading and punching dried blood spots can become a tedious task. Thus, some form of semi- or full-automation is desired. Various approaches for automation have been used. One such robotic automation device punches out 96 blood disks in 15-20 minutes. Other approaches elute the analytes directly from the card while another ionizes analytes from the card into the gas phase and transfers them to a mass spectrometer. This field is rather new and giving details of experimental approaches is beyond the scope of this Chapter. Readers are referred to review articles that further describe the process<sup>9-12</sup>.

## Protein Removal

Urine and blood plasma from humans and a variety of animal species are the most commonly analyzed biofluids. Protein removal is an essential step in sample preparation for the LC-MS/MS analysis of compounds in biological matrices. One of the main reasons that many biofluids cannot be analyzed directly by LC-MS/MS is that the high protein content would cause a rapid deterioration in the performance of the HPLC column and ion source contamination in the mass spectrometer. A variety of techniques can be used to remove or reduce the protein content of plasma. **Table 16.2** lists a number of the more popular protein removal techniques. For many years, prior to the widespread acceptance of tandem mass spectroscopic techniques, LLE and SPE were the predominant techniques for removing proteins. However, both of these sample preparation techniques require method development and multistep processes. For example, LLE may require direct and back extractions to remove proteins while SPE requires investigation of various sorbents, extraction, washing, and elution solvents and pH adjustment to provide optimum cleanup and recovery of drugs and metabolites. Protein precipitation has now become more commonplace and works reasonably well as long as contaminants do not cause undue ion suppression or ion enhancement effects in the MS detector.

## Protein Precipitation

Protein precipitation (sometimes called protein “crashing”) is a popular choice for sample preparation, since some samples can sometimes be directly injected into the HPLC column after precipitation. Little method development is required and simple equipment and reagents are used. However, the technique does not concentrate the analytes and, in fact, a dilution occurs. In addition, sample cleanup is limited. Depending on the precipitation reagent used, experimental conditions, and the species from which the plasma was derived, up to 98% of the proteins in the sample can be removed. However, other excipients such as salts, lipids and phospholipids may still remain in the supernatant.

The principle of protein precipitation is very simple (see **Figure 16.3**). By adding a chemical reagent to the plasma sample, the objective is to markedly reduce the solubility of the proteins in the sample causing them to precipitate. This precipitate can be removed by filtration or centrifugation leaving a clear supernatant or filtrate that is usually injected directly into the HPLC or LC-MS/MS system. The four main reagents used to precipitate plasma proteins are listed in **Table 16.3**.

Figure 16.3

### Protein Precipitation

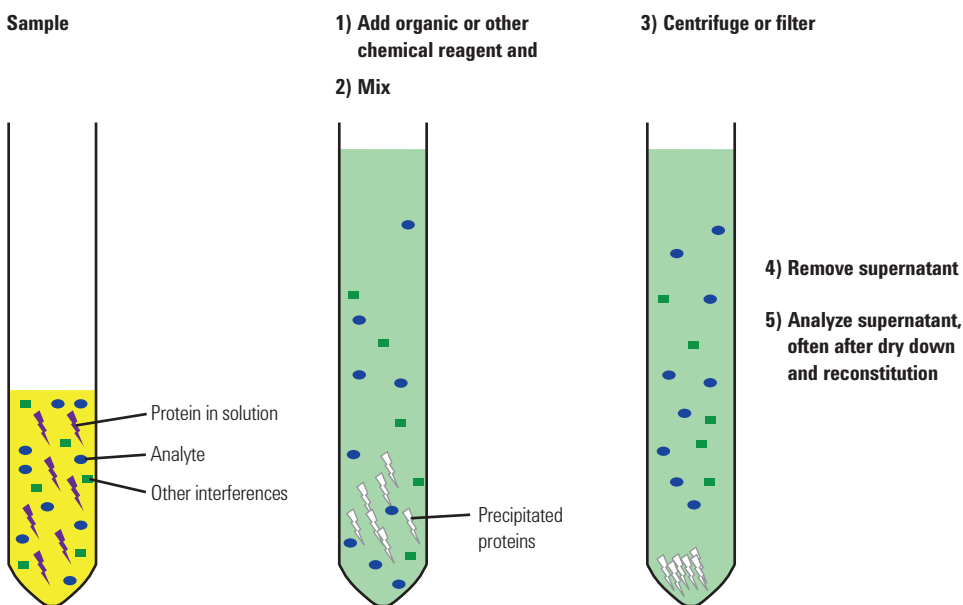

Table 16.2

Techniques for Removal of Protein from Biological Fluids		
Protein Removal Technique	Principle	Reference(s)
Precipitation	Organic solvent (e.g. acetonitrile, methanol), acid solution (e.g. perchloric, formic, trichloroacetic) or salt solution (e.g. sodium sulfate, ammonium sulfate) is added with agitation to a solution of plasma. The protein precipitates and forms a bead that can be removed by centrifugation or filtration. Supernatant liquid can be analyzed by HPLC.	13-16
Restricted Access Media (RAM) (see Chapter 10)	Solution containing protein is injected into a RAM column which has a short chain hydrophilic bonded phase like an alkyl diol designed to reject proteins and allow small molecules to diffuse into pores where a bonded reversed-phase interacts with small molecules; the protein portion can be vented to waste using a switching valve; a similar material has a hydrophilic polymer that performs the same task by shielding the underlying C18 phase.	17-21
Turbulent Flow Chromatography	A large particle (~50 $\mu\text{m}$ ) small diameter bonded silica reversed-phase column (1 mm id) is run at very high linear velocities up to 8 mL/min flow rate; although Reynolds numbers are not in the turbulent flow range, these high linear velocities do not allow the slower diffusing proteins and other plasma components to penetrate the pores of the packing and they are flushed to waste; smaller molecules, usually drugs and their metabolites, can penetrate the pores and are retained by reversed-phase mechanisms. The small molecules are then eluted with aqueous-organic mobile phase into a mass spectrometer.	22-25
Ion Exchange (see Chapter 9)	An ion exchange column can be used to selectively retain large biomolecules by adjusting the pH of the mobile phase to generate a net positive or negative charge on the protein portion of a biological fluid; small molecules may pass through unretained and may be focused on a secondary column for subsequent analysis by HPLC. Off-line and on-line approaches can be used.	26-28
Size Exclusion Chromatography (see Chapter 11)	By choice of an appropriate small pore size aqueous-compatible packing material, proteins can be excluded and elute from the column first while the small molecular weight compounds elute closer to the total permeation volume.	29-34
Reversed-Phase (see Chapter 9)	The use of less hydrophobic short alkyl chain phases like C3 or C4 bonded to wide pore silicas will retain proteins and have less interaction with polar drugs so that they can be used to retain proteins and allow small molecules to pass through.	35-36
High-Abundance Protein Depletion (see Chapter 15)	High abundance proteins (up to 20) from human and other plasma/serum samples are depleted by antibody affinity phases bonded to a solid packing; low abundance proteins are collected as unretained peaks since there is no interaction with the column media. They can be concentrated by trace enrichment techniques and further investigated. This technique is mostly used for the investigation of low abundance proteins rather than for the analysis of drugs and metabolites in biofluids.	37-41

The most popular method is the addition of organic solvent. Organic solvents act by lowering the dielectric constant of the plasma protein solution, thereby increasing electrostatic interaction between the protein molecules. The organic solvent also tends to displace water molecules associated with the hydrophobic portion of the protein. By minimizing the hydrophobic interactions and increasing electrostatic interactions, the proteins aggregate, and therefore precipitate. The acidic reagents form insoluble salts with the positively charged amino groups in the protein molecules occurring at any pH below their isoelectric point. Metal ions bind to amino groups on the protein, thereby displacing protons. This also lowers the isoelectric point of the protein and the displaced protons also lower the solution pH, leading to precipitation. High salt concentrations reduce the availability of water molecules, dehydrates the protein and, in turn, increases hydrophobic-hydrophobic interactions leading to protein aggregation.

Table 16.3

Chemical Reagents for Protein Precipitation from Plasma		
Type of Reagent	Typical Reagents	Comments
Organic solvent	Acetonitrile, methanol, ethanol	Acetonitrile is the most popular; irreversibly denatures three-dimensional structure of proteins
Acids	Trichloroacetic acid, perchloric acid, tungstic acid	Irreversibly denatures three-dimensional structure of proteins
Metal ions	Zinc hydroxide, copper sulfate-sodium tungstate	
Salts	Ammonium sulfate	Salting out effect; denaturation potentially reversible by dialyzing out the excess salt

After precipitation, the denatured protein can be removed by centrifugation or filtration to leave a clear supernatant an aliquot of which can be transferred to another tube or vial. If a centrifuge is used, one should use relatively high g-force (10,000-15,000 g) to separate the precipitated protein. Centrifugation is not particularly well-suited for high-throughput environments due to the multiple manual steps involved. For such laboratories, the 96-well filtration plate “flow-through” format has become quite popular and equipment is available to automate the entire process. Each well in this format contains at its base a small membrane filter which filters out precipitated protein, allowing the supernatant liquid to be collected at the exit in a 96-well collection plate. With this format, the “solvent-first” method is the most efficient for precipitation of proteins from plasma. However, in a regular 96-well filtration plate, low viscosity solvents like acetonitrile will prematurely begin to drip from the plate by gravity before the plasma can be added. Special new non-drip plates such as Agilent Technologies’ Captiva ND plate have been specially designed using filtration materials that effectively hold organic solvents used for precipitation with no dripping. Flow-through the membrane only occurs when a vacuum is applied. This prevents sample loss and enables trouble-free automated methods. Simply add the organic solvent followed by the biological sample, mix them well, and apply vacuum to filter out precipitated proteins. The result is a particulate-free, protein-free sample in just a few minutes. For those who have fewer samples and do not want to use a 96-well filtration plate, single membrane versions of the Captiva filter are available in the SPE cartridge format and disposable membrane filter format.

An example is shown here of the use of non-drip 96-well filtration plates and centrifugation for the sample preparation of plasma spiked with beta-blocker drugs<sup>42</sup>. Table 16.4 provides the steps and time involved in each step when performing the sample preparation process. The centrifugation process required several manual steps while the 96-well process could be fully automated, thereby saving considerable time and avoiding much manual manipulation. Several experimental tests were performed to illustrate the effectiveness of the protein precipitation process using membrane filtration. Over 5,000 injections of the supernatant filtered sample was injected into a microparticulate 1.8 µm ZORBAX Eclipse Plus HPLC column (2.1 x 50 mm) using gradient elution and the pressure on the column remained relatively constant, indicating that protein removal was more than adequate. Retention time and MS peak area data for the beta blockers (Metoprolol, Nadolol, Pindolol, and Propranolol) also remained constant over the same number of injections.

**Table 16.4**

<b>Sample Preparation Time Comparison for Protein Precipitation Using Agilent Technologies' Captiva ND 96-well Filtration and Centrifugation Methods<sup>42</sup></b>			
<b>Centrifugation</b>	<b>Time (min)</b>	<b>96-well Filtration</b>	<b>Time (min)</b>
Add 0.2 mL of spiked plasma sample and 0.6 mL of the acetonitrile +0.1% formic acid to centrifugation tube or an empty 96-well plate	5	Add 0.2 mL of spiked plasma sample and 0.6 mL of acetonitrile +0.1% formic acid to the non-drip 96-well plate	5
Centrifuge at 10,000 RPM for 10 min	11	Mix each well with the pipette five times and apply vacuum	
Transfer supernatant to 2 mL injection vials (if tubes were used) or a new empty 96-well plate for analysis (if plate format was used)	10	Directly transfer injection plate for analysis	0
Total time required for sample preparation	26	Total time required for sample preparation	5

# Removal of Lipophilic Material

As stated earlier, protein precipitation, for the most part, only removes proteins from the plasma sample. Salts, a lesser level of proteins, lipids, phospholipids, lysophosphatidylcholines, and other excipients still remain in the supernatant. Since reversed-phase HPLC is the main technique for determining drugs and biological fluids, the salts remaining in the supernatant are not much of a problem since most salts elute from a reversed-phase column with or near the solvent front. However, the lipophilic compounds can be a problem since they show up later in the hydrophobic portion of the reversed-phase chromatogram and interfere with the separation, lodge on the column and bleed later and/or cause ion suppression with the MS signal. Solid-phase extraction can be used to remove some of these compounds, but that adds extra complexity to the sample prep process.

A faster and more cost effective procedure to remove these lipophilic compounds is the use of the Captiva ND<sup>Lipids</sup> 96-well filtration plate or its single tube equivalent. **Figure 16.4** shows how this filtration plate is used to remove both precipitated proteins and lipids from a plasma sample. The device uses a double filter: initial non-drip filter removes precipitated protein while secondary filter (proprietary) removes lipophilic compounds. Normally, a 50-200  $\mu$ L plasma sample is used. The precipitation reagent, sometimes called the crash solvent, methanol or acetonitrile, is added in a 3:1 organic:plasma ratio. A pH modification can be made to ionize analyte(s) of interest. For basic compounds, we recommend 0.1%-1% formic acid in methanol. For acidic compounds, we recommend 5-10 mM ammonium formate buffer at pH 9. For more thorough precipitation, pipette mixing is recommended rather than the use of orbital or vortex mixing. The filtration/lipid removal step should take five minutes or less.

Figure 16.4  
**Captiva ND<sup>Lipids</sup> Lipid/  
Protein Removal Filtration Plate**

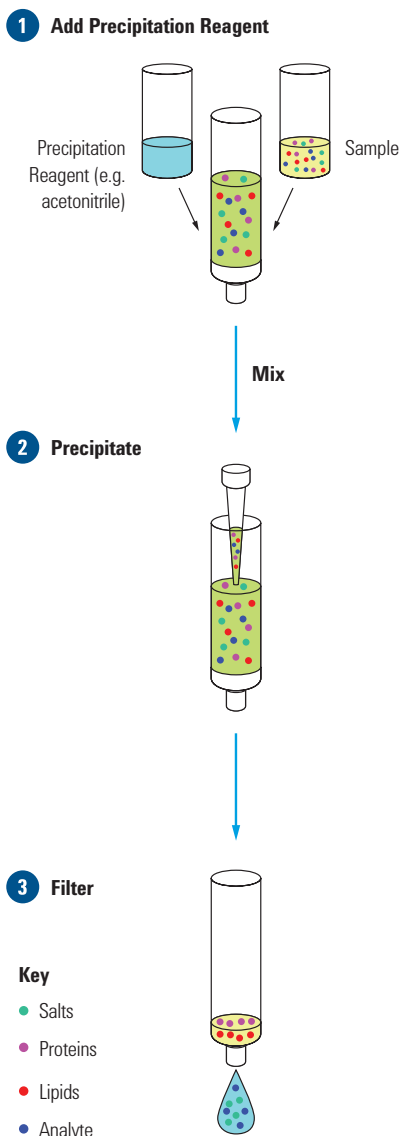

**Figure 16.5** shows a comparison of the removal of lipophilic materials from plasma using Captiva ND versus Captiva ND<sup>Lipids</sup>. Using the 184 → 184 (in-source fragmentation) MRM transition, phosphatidylcholines can be monitored as an indication of ion suppression. One can see from **Figure 16.5** that the majority of the lipid-containing materials are reduced. A further comparison is shown in **Figure 16.6** which uses post-column infusion studies for lipids and compares the various methods used for preparing plasma samples. It is obvious from this comparison that protein precipitation leaves much to be desired if one is worried about lipophilic ion suppression during LC-MS/MS. Both SPE and liquid-liquid extraction do a fair job of cleaning up the plasma sample. But, the combined lipid-stripped protein precipitation procedure gives the best overall baseline. An alternative approach in removing phosphorous-containing compounds is to use titanium- or zirconium-oxide-based sorbents, which have a high affinity for phosphorous.

Figure 16.5

### Use of Captiva ND<sup>Lipids</sup> Removal Device

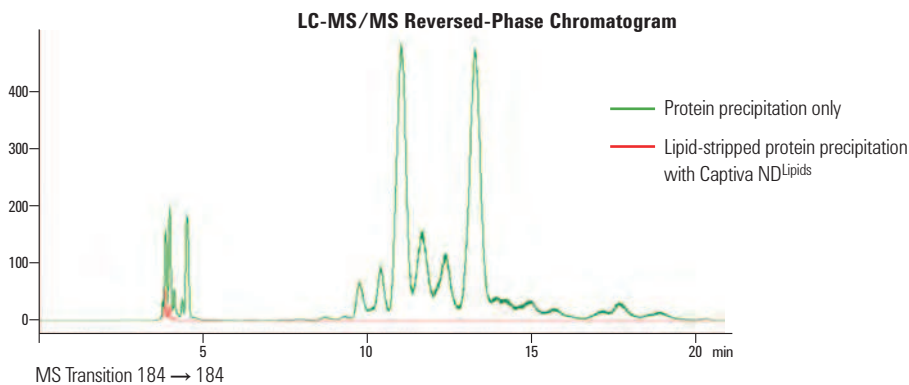
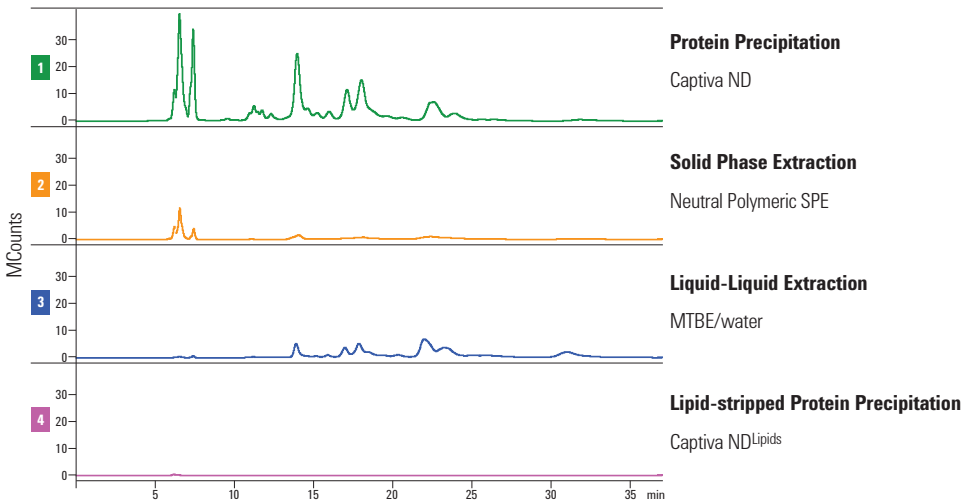

Figure 16.6

## Post-column Infusion Studies: Lipids



## Sample Preparation of Biological Tissue Samples\*

Preparation of biological tissue samples remains an extremely tedious and time-consuming laboratory task. From the moment the tissue is excised, great attention must be paid to how the sample is stored, processed (whether mechanical or chemical), extracted, and finally analyzed. Once this process is complete, the utility of the data obtained from tissue as well as its analytical quality (accuracy, precision and reproducibility) is still debatable. Despite the somewhat thankless nature of tissue analysis, significant progress has been made in the last decade to explore alternative tissue sample preparation approaches as well as obtain a better understanding of the risks and benefits of conventional methods. An overview of human and animal tissue sample preparation focusing on quantitative bioanalytical applications will be presented here. However, applications for microscopy, imaging and elemental analysis will not be covered. Both traditional extraction technologies and new approaches will be reviewed and compared.

\*Partially extracted from Reference 43



## Why Tissue Analysis?

Several application areas for which tissue preparation is needed include pharmaceuticals, molecular biology, food science, forensics, and toxicology. In pharmaceutical research, quantitative analysis of tissue may be carried out to assess the tissue uptake at the site of drug action, correlate drug concentration with pharmacokinetic and pharmacodynamic response, and predict toxicity and dose. Tissue samples may also be processed to obtain proteins, peptides, purified DNA or RNA for molecular biology research. Determination of preservatives, pesticides residue, growth hormones and drug residues in feed animal tissues is important in food science. For example, the use of antibiotics in food animals has generated growing concern since lingering traces of fluoroquinolone antibiotics may contribute to increased bacterial resistance in humans who consume the meat. Another important avenue for tissue analysis is forensic or toxicology purposes, whether to confirm the identity of an alleged suspect from crime scene evidence or to determine if poisoning or overdose has occurred. Because DNA can be extracted from almost any human tissue, extracted DNA from crime scene evidence can be compared to extracted DNA from known individuals. For toxicological or DNA testing, tissues are generally utilized together with blood, urine, and hair.

## Types of Tissue Preparation Techniques

Tissue preparation techniques can be categorized into mechanical, digestion, or extraction instruments. Some of the techniques used successfully for other types of solid samples (Chapter 14), such as soil or plant material, may also be used for tissues. Tissue samples, although solid, should be considered highly aqueous in nature, which can be exploited to rupture cells within the tissue matrix. Generally, chunks of tissue are snap frozen in liquid nitrogen immediately after sampling, and are stored at very low temperatures (-20 or -70 °C) prior to processing. Just as with any biological matrix, proper biohazard safety precautions should be followed. Tissue samples are best processed immediately after removal from the freezer, since thawing will produce a rubbery nugget that evades slicing or dicing. If a large number of tissues must be prepared, several small batches should be serially processed rather than allowing the entire set of samples to thaw.

A simple comparison of the techniques is shown in **Table 16.5**. The workflows for the tissue preparation methods described are shown in **Figure 16.7**. Each technique has both advantages and disadvantages, and some may be used in combination for optimum extraction.

Table 16.5

<b>Tissue Preparation Techniques</b>						
<b>Technique</b>	<b>Primary Application</b>	<b>Handles Whole Tissue Chunks</b>	<b>Analyte Stability Issues</b>	<b>Automation</b>	<b>Inexpensive</b>	<b>High Sample Throughput</b>
Homogenizer	Small molecules, proteins, peptides, DNA, RNA	Yes	No	No	Yes	No
Ultrasonicator		No	No	No	No	No
Bead Beater	DNA, nucleic acids	Yes	No	Yes	Yes	Yes
Freezer/Mill		Yes	No	Yes	No	Yes
Autogizer	Small molecules, proteins, peptides, DNA, RNA	Yes	No	Yes	No	Yes
Acid or Base	DNA, nucleic acids	Yes	Yes	No	Yes	Yes
Enzymatic	Small molecules, DNA, nucleic acids	Yes	Maybe	Maybe	Yes	Yes
Accelerated Solvent (ASE) or Pressurized Fluid Extraction	Environmental (soil, foods)	Yes	Yes	Yes	No	Yes
Microwave-Accelerated		No	Yes	Yes	No	Yes
Pressure Cycling Technology (PCT)	DNA, nucleic acids	Yes	No	Yes	No	Yes

Figure 16.7

## Workflow Comparison of Tissue Preparation Methods

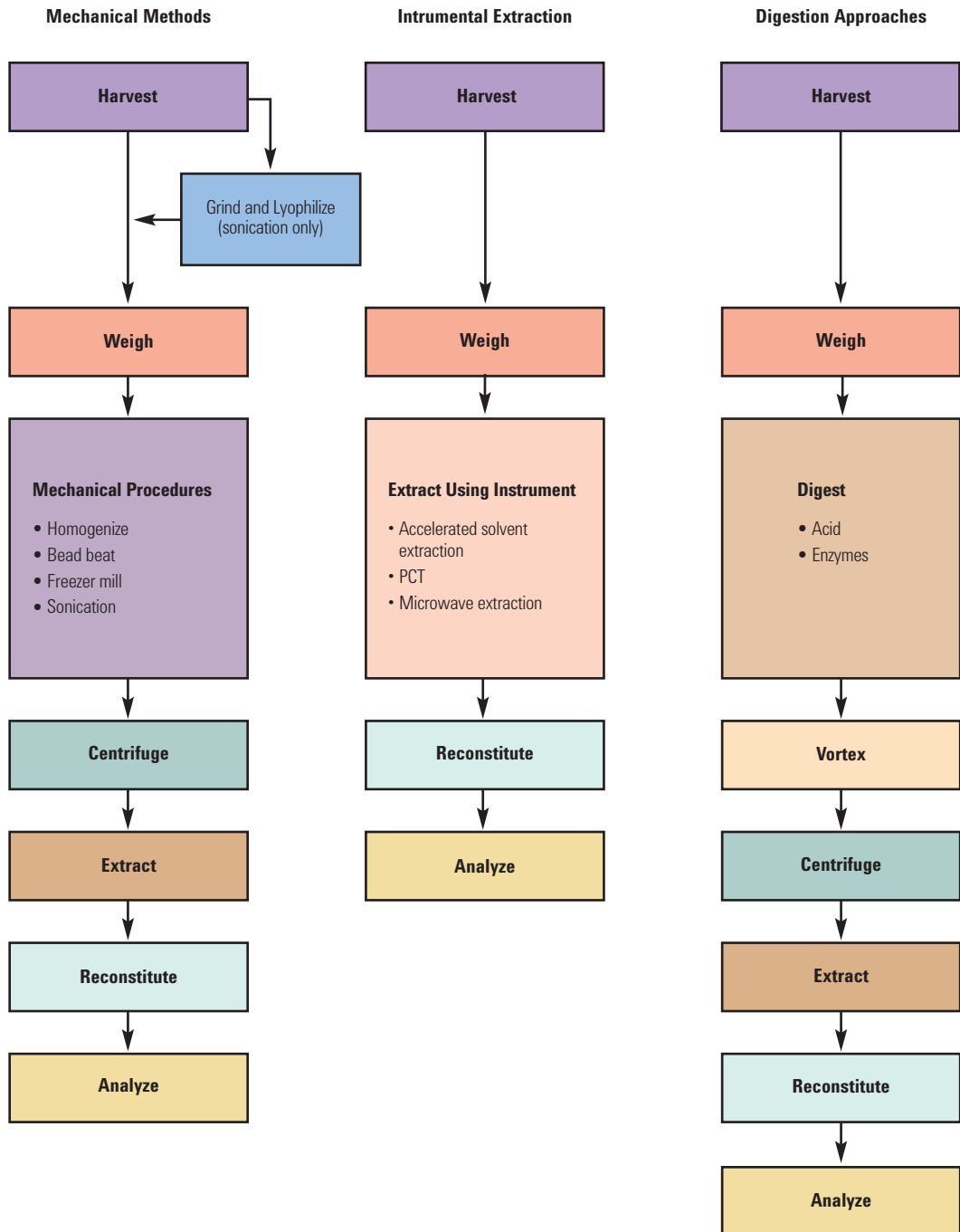

## Mechanical Techniques

Homogenization or “grinding” remains the most popular and generally practical means of preparing tissues for a range of qualitative or quantitative applications. Initially, a small stainless steel probe-style blender, containing a generator and a set of blades, causes vigorous mixing and turbulence as well as physically shearing of the sample into small pieces. Next, a weighed amount of sample, which may range from 10 mg to 1 g in size, is placed in a vial with a known volume of buffer solution. The pH of the buffer can be tailored to the desired extraction conditions. The resulting product, or homogenate, is semi-solid in nature and can be essentially treated in the same manner as plasma. Lengthening the homogenization step, or centrifuging the homogenate and decanting the supernatant will minimize large particles in the homogenate.

Homogenizers are small, compact, relatively inexpensive, and require minimal training to operate. However, extended exposure to high velocity blending can be irritating, and ear protection should be worn. The probe should be thoroughly and repeatedly rinsed between each sample to avoid cross contamination. A parallel homogenizer can be used to speed up the homogenization process using a multi-probe, parallel processing approach. This type of homogenizer features a 4 or 6 probe assembly of homogenizers or sonicators with a range of cutter sizes. The probes are cleaned automatically with three programmable wash stations. The sidebar on page 248, “Homogenization Procedure for Analysis of Desipramine in Rat Brain Tissue” outlines a typical sample preparation procedure for the analysis of desipramine in brain tissue using homogenization.

Sonication is one alternative to homogenization. In sonication, the tissue sample is snap frozen, and then immediately ground to a fine powder using a mortar and pestle in a liquid nitrogen bath. The weighed powder is stored and when ready for analysis, mixed with a known volume of buffer and sonicated using a specially designed acoustical tool, horn or probe placed directly into the powder-buffer mixture. This method is more straightforward than homogenization, but powderizing tissue requires significant manual labor and may lead to occupational health problems such as carpal tunnel syndrome. As with the homogenizer, the sonic probe should be thoroughly cleaned between samples.

The bead beater represents a more hands-off approach to tissue sample preparation. Introduced 25 years ago by BioSpec Products (Bartlesville, OK), the bead beater is a unique but simply designed apparatus using small beads and a high-speed rotor to rupture cells. A solid polytetrafluoroethylene impeller rotating at high speed forces thousands of minute beads to collide in a specially shaped vessel. Cells are disrupted quickly, efficiently and safely. Each sample is placed in a separate tube with a defined amount of beads and buffer solution, and then agitated for 15-20 minutes. Homogenization inside disposable microcentrifuge vials guarantees that cross-contamination of samples is minimized.

A variation of the bead beater is the freezer mill from SPEX Certi-Prep (Metuchen, NJ) which uses small magnetic bars, rather than beads, to pulverize the sample. Cooling is provided by immersing the sample chambers in a liquid nitrogen bath. The freezer mill is intended for larger samples (>500 mg) but may be customized for smaller samples. Both the freezer mill and the bead beater require that the sample be placed in secondary containers, which may or may not be disposable. Cleaning of non-disposable sample containers can be labor intensive and should be avoided if possible through use of disposable devices.

An innovative technique well-known to the food science community but less to pharmaceutical researchers is Matrix Solid Phase Dispersion (MSPD, see Chapter 10), pioneered by Steven Barker of Louisiana State University<sup>44-45</sup>. Similar to mechanical techniques such as the bead beater, MSPD relies on the shear forces generated by mixing tissue samples with large (>50  $\mu\text{m}$ ) silica particles and grinding with a mortar and pestle. Analytes such as pesticides or drugs can be extracted from tissue using a range of stationary phase chemistries. The analyte remains on the silica- or bonded-silica particles and can later be eluted with an appropriate solvent. The current multi-step process requires repeated and careful manual intervention, but could conceivably be automated or combined with some of the previously described devices.

An application for the analysis of mycotoxins – not in human but in fish tissue – based on MSPD on-line with SPE cleanup followed by LC-MS/MS has been published<sup>46</sup>. In this publication, the authors measured zearalenone (ZON), a non-steroidal estrogenic macrocyclic lactone mycotoxin in rainbow trout at the ppb level. The fish was first chopped into small pieces, refrigerated, then placed in a glass mortar. A 2 g portion of C18 SPE phase was added to the mortar and the contents were vigorously mixed with the pestle to obtain homogeneity. The resulting powder was dried in an oven at 40 °C. Next, the mixture was packed into a 6 mL polypropylene column fitted with polyethylene fritted disks. The column was then connected in series to another SPE column packed with graphitized carbon black (GCB). The ZON was eluted from the upper column (from the MSPD experiment) to the lower SPE column using a methanol-water (70-30 v/v) mixture. The ZON and interferences were captured on the GCB column. After washing with a series of solvents to remove interferences, the ZON was eluted with dichloromethane-methanol mixture (80-20 v/v). After collecting the effluent, it was evaporated to dryness under nitrogen and reconstituted with LC-compatible solvent and analyzed by LC-MS/MS. In their method development, the authors also used alumina as a matrix dispersing reagent, but found that C18 gave superior recoveries and lower % RSDs.

### **Homogenization Procedure for Analysis of Desipramine in Rat Brain Tissue**

1. For samples, place a weighed chunk of brain tissue in a vial. Add an appropriate amount of deionized water to achieve 0.1 g tissue/mL water.
2. For standards and quality control samples, place a weighed chunk of brain tissue in a vial. Spike an appropriate volume of 10 mg/mL stock solution of desipramine and deionized water to achieve 0.1 g tissue/mL water.
3. Homogenize at least 300 mg blank tissue in 3 mL deionized water to obtain enough blank matrix for preparation of the standard curve, quality controls, and blanks.
4. Homogenize samples, initial working standard and quality controls for 3-5 minutes, cleaning the probe after each.
5. Dilute the working standard and quality control with blank homogenate to obtain standards and quality controls over the desired dynamic range. Vortex well.
6. Mix a 100 µL aliquot of samples, standards, quality control and blanks with 200 µL of 200 ng/mL haloperidol (internal standard) in acetonitrile (protein precipitation sample extraction).
7. Vortex mix for 5 minutes, centrifuge at 4,000 RPM and 4 °C for 5-10 min.
8. Transfer the supernatants and inject onto the LC-MS/MS system.

## Digestion Techniques

Mechanical techniques might do little to disrupt cellular structure and extract analytes from non-vascularized or low-water-content tissues such as bone, cartilage or hair. Extreme measures such as digestion with strong acid (e.g. 12 N Hydrochloric acid) are routinely used for DNA or nucleic acids, which can tolerate the harsh conditions. Alternatively, certain enzymes can be used to digest tissue samples.

Commercial devices are available which contain digestion bombs fabricated from material resistant to corrosive media. These digestion bombs can also be used as containers for microwave extraction systems covered later.

Enzymatic digestion, a technique commonly used for tissue dissociation and cell harvesting of proteins and DNA, offers the advantages of unattended sample preparation, potential automation, and low cost. A range of different enzymes is available with different digestive properties and efficiencies. The choice of enzyme can be driven by the desired tissue or component, such as cartilage, to be digested. Although the enzymatic digestion technique has been utilized for decades, very little has been published that describe enzymatic digestion in tissue sample preparation for small molecules<sup>47</sup>.

The feasibility of enzymatic digestion has been studied as an alternate tissue preparation technique for bioanalysis of drugs<sup>48</sup>. Two different enzymes known to degrade connective tissues to allow tissue dissolution were chosen for evaluation: collagenase and proteinase K. These enzymes were selected to represent both a more conservative digestive enzyme (collagenase) and a more aggressively digestive enzyme (proteinase K). Results indicate that enzymatic digestion has comparable extraction efficiency to homogenization and enzymatic digestion using collagenase or proteinase K can be considered as an alternative sample preparation method for analysis of small molecules in tissue.

Test compound levels of incurred rat brain tissue samples prepared by enzymatic digestion were in good agreement with the values obtained by the conventional homogenization tissue preparation; indicating that enzymatic digestion is an appropriate tissue sample preparation method<sup>48</sup>. A variety of other enzymes, such as trypsin, papain, or elastase might also be utilized depending on the degree of digestive strength needed.

## Extraction Instruments

Some of the extraction instruments used for other types of solid samples have been evaluated or at least considered for tissue samples. However, the intended use may impact instrument design with respect to sample size. The number and size of sample chambers or vials as well as final extract volume should be considered when using these instruments. Pressurized fluid extraction (PFE) instruments (Chapter 14) use liquid solvents at elevated temperatures and pressures to extract analytes from solid or semi-solid samples in very short periods of time and with small volumes of solvent. With PFE, the sample is enclosed in a stainless steel vessel filled with an extraction solvent that is pressurized and heated. The sample is allowed to statically extract for 5-10 min, with the expanding solvent vented to a collection vial.

Next, compressed nitrogen purges the remaining solvent into the same vial. Because the technique uses liquid solvents, it can be applied to any application in which liquid solvents are currently used. The entire procedure typically requires less than 15 min and approximately 15 mL of solvent for a 10 g sample<sup>49</sup>. The technique has been used for extraction of small molecules from animal-, plant- and fish-tissue, food, polymers, and many types of environmental contaminants in soil.

Microwave-Accelerated Extraction (Chapter 14) has also been widely applied to solid samples as a means to speed the extraction process. Microwave heating can drive a variety of chemical processes including acid digestion. However, the thermal instability of most types of tissue and analytes within the tissue has limited the applicability of this technique to tissues.

A new type of extraction instrument is based on pressure cycling technology (PCT). This process uses repeated cycles of ultra-high and ambient pressure to extract proteins and nucleic acids from tissues<sup>50</sup>. This new technology has been applied to the quantitative extraction of nucleic acids, proteins, and small molecules from a wide variety of organisms including, viruses, bacteria, plant and animal cells and tissues.



# Considerations When Choosing a Tissue Preparation Technique

How to choose the best tissue preparation technique for application is a difficult question to address. Sample throughput, analyte recovery, analyte thermal stability, amount of available sample, available sample preparation techniques, precision, accuracy, manual labor involved, and operator safety are only a few of the parameters that must be considered when selecting the optimum sample preparation technique. A comparison of the typical preparation times required for 50 tissue samples using various techniques is shown in **Figure 16.8**<sup>43</sup>.

In general, the simplest approach, homogenization may be both safest and most cost-effective. However, if your laboratory will require the analyses of dozens of tissue samples per month, investing in new technologies may be justifiable and cost-effective. Some of the instruments used for other types of solid samples may be modified to prepare tissues. However, the scientist should judiciously consider whether the risks (cross-contamination, manual intervention, analyte instability) are outweighed by the benefits. Carryover between individual samples should be minimized and the technique should be compatible with the analytical method that you will be using (i.e., GC, LC/MS, etc.). The nature of the tissue itself should also be considered, since more fibrous connective tissues such as muscle will require more vigorous preparation than highly aqueous tissues such as cornea.

Tissue analysis presents its own set of unique challenges. A universal lack of reference material for any analyte in appropriate or comparable matrix exists, regardless of the application. Questions around spatial distribution heterogeneity of the analyte within the tissue matrix are rarely answered, unless an imaging technique such as autoradiography is utilized. Tissue quantitation requires tedious sample weighing (slicing and dicing), for good accuracy and precision. Thus, techniques that mandate an exact amount of tissue, such as ASE, will require significant time just to weigh the tissue. Although an internal standard (IS) is routinely utilized, it is generally added as a solution to the homogenate, digest, or extract after preparation. Unfortunately no physical means has been discovered to disperse the internal standard into the tissue matrix, and extraction efficiency of the IS in matrix cannot be determined.

Extraction instruments for other solid samples often exhibit difficulty in scaling up or down between various devices and will require purchasing sample containers specific to the sample weight range. Correlation of extraction efficiency of the analyte between analytical standards and samples is always incomplete and often impossible. However, despite these challenges, the scientist has a choice between tried and true methods such as homogenization and more novel yet cost-effective approaches including enzymatic digestion and 96-well bead beater apparatus.

Figure 16.8

## Comparison of Total Extraction Times for Various Sample Preparation Methods

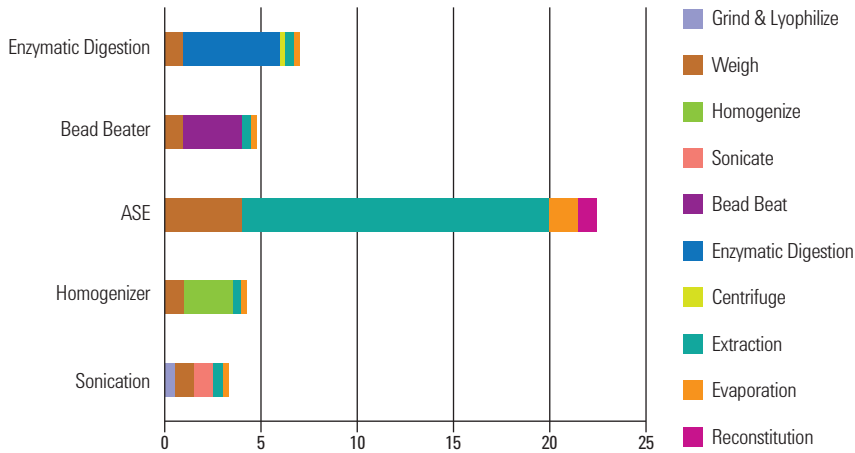

A sample set of 50 was used for calculations. Times shown are typical and independent of tissue type.

## Conclusions

Although traditional biological sample preparation methods have been carried out for years, the demand for increased productivity, faster and high-throughput assays has driven investigation of new technologies. Compared to these traditional approaches, these new techniques are expected to be faster and provide at least equivalent, if not superior, reproducibility and analyte extraction efficiency. Automation using the 96-well plate format has helped to increase overall productivity and more and more sample preparation techniques (e.g. liquid-liquid extraction, supported liquid extraction, filtration, protein precipitation, etc.) have gone to this format. For liquid samples such as whole blood, plasma and urine, transfer of manual methods to automated methods can be fairly easily carried out. In the area of tissue sample preparation, users have many choices from conventional homogenization or sonication to newer technologies such as enzymatic digestion and pressure cycling technology. These techniques should be compared in terms of speed, cost, and degree of automation.

## References

1. Morello, R.; Milokovic, J.; Boos, K.-S. *Therapeutic Drug Monitor* **2007**, *29*, 505.
2. Berger, I.; Morello, R.; Boos, K.-S. *LC-MS/MS Analysis of Drugs in Whole Blood: A Unique Solution for Total Automation and Undisturbed Detection*, Poster P-527-W, presented at HPLC 2010, Boston, MA, **June 19-24, 2010**.
3. Berger, I.; Morello, R.; Kinzig, M.; Boos, K.-S. *LC-MS/MS Analysis of Immunosuppressants in Whole Blood: Comparison of Dried Blood Spots, Heat Shock or Cryogenically Treated Blood and Denatured Blood*, Poster P-528-M, presented at HPLC 2010, Boston, MA, **June 19-24, 2010**.
4. Bang, I. *Ein Verfahren zur Mikrobestimmung von Blutbestandteilen*, *Biochem. Ztschr.* **1913**, *49*, 19-39.
5. Guthrie, R.; Susi, A. *Pediatrics* **1963**, *32*, 338-343.
6. Bowen, C. *American Laboratory* **2010**, *42 (10)*, 11-14.
7. Evans, C.A. *The Application of Dried Blood Spots for Quantitation of Xenobiotics – A Paradigm Shift within Pre-Clinical DMPK*, The Delaware Valley Drug Metabolism Discussion Group, **February 11, 2010**.
8. Patrone, L.M. *Direct Comparison of DBS Analysis to Plasma and Whole Blood Analysis in Toxicokinetic Studies of Rats, EBF Workshop Connecting Strategies on Dried Blood Spots*, Brussels, Belgium, **June 17-18, 2010**.
9. Spooner, N.; Lad, R.; Barfield, M. *Anal. Chem.* **2009**, *81 (4)*, 1557-1563.
10. Abu-Rabie, P.; Spooner, N. *Anal. Chem.* **2009**, *81 (24)*, 10275-10284.
11. Sausseureau, E.; Lacroix, C.; Gaulier, J.M.; Gouille, J.P. *J. Chromatogr. B* **2012**, *885-886*, 1-7.
12. Majors, R.E. *LCGC No. America* **2011**, *29 (1)*, 14-27.
13. Biddlecombe, R.A.; Pleasance, S. *J. Chromatogr. B*, **1999**, *734 (2)*, 257-265.
14. Li, J.; Wang, L.; Chen, Z.; Xie, R.; Li, Y.; Hang, T.; Fan, G. *J. Chromatogr. B* **2012**, *895-896*, 83-88.
15. Dawes, M.L.; Gu, H.; Wang, J.; Schuster, A.E.; Haulenbeek, J. *J. Chromatogr. B* **2013**, *934*, 1-7.
16. Makkar, H.P.S. *J. Agric. Food Chem.* **1989**, *37 (4)*, 1197-1202.
17. Oliveira, R. V.; Cass, Q.B. *J. Agric. Food Chem.* **2006**, *54 (4)*, 1180-1187.
18. Wa, C.; Maltik, R.; Hage, D.S. *Anal. Chem.* **2008**, *80 (22)*, 8751-8762.
19. Santos-Neto, A.J.; Markides, K.E.; Sjoberg, P.J.R.; Bergquist, J.; Lancas, F.M. *Anal. Chem.* **2007**, *79 (16)*, 6359-6367.
20. Willemsen, O.; Machtejevas, E.; Unger, K.K. *J. Chromatogr. A* **2004**, *1025 (2)*, 209-216.
21. Rbeida, O.; Christiaens, B.; Hubert, Ph.; Lubda, D.; Boos, K.-S.; Crommen, J.; Chiap, P. *J. Chromatogr. A* **2004**, *1030 (1-2)*, 95-102.
22. Herman, J.L.; Edge, T. *LCGC No. America* **2012**, *30 (3)*, 200-214.
23. Xin, G.-Z.; Zhou, J.-L.; Qi, L.-W.; Li, C.-Y.; Liu, P.; Wen, X.; Li, P. *J. Chromatogr. B* **2010**, *878 (3-4)*, 435-441.
24. Bunch, D.R.; Heideloff, C.; Ritchie, J.C.; Wang, S. *J. Chromatogr. B* **2010**, *878 (31)*, 3255-3258.
25. Mottier, P.; Hammel, Y.-A.; Gremaud, E.; Guy, P.A.; *J. Agric. Food Chem.* **2007**, *56 (1)*, 35-43.

(Continued)

## References (Continued)

26. Mansson, M.; Phipps, R.K.; Gram, L.; Munro, M.H.G.; Larsen, T.O.; Nielson, K.F. *J. Nat. Prod.* **2010**, *73* (6), 1126-1132.
27. Wang, L.-Q.; Zeng, Z.-L.; Su, Y.-J.; Zhang, G.-K.; Zhong, X.-L.; Liang, Z.-P.; He, L.-M. *J. Agric. Food Chem.* **2012**, *60* (25), 6359-6363.
28. Reedy, C.R.; Hagan, K.A.; Strachan, B.C.; Higgonson, J.J.; Bienvenue, J.M.; Greenspoon, S.A.; Ferrance, J.P.; Landers, J.L. *Anal. Chem.* **2010**, *82* (13), 5669-5678.
29. Bertini, S.; Bislo, A.; Torri, G.; Bensi, D.; Terbojevich, M. *Biomacromolecules* **2005**, *6* (1), 168-173.
30. Hu, L.; Li, X.; Jiang, X.; Zhou, H.; Jiang, X.; Kong, L.; Ye, M.; Zou, H. *J. Proteome Res.* **2007**, *6* (2), 801-808.
31. Lindemann, T.; Hintelmann, H. *Anal. Chem.* **2002**, *74* (18), 4602-4610.
32. Mandal, B.K.; Suzuki, K.T.; Anzai, K.; Yamaguchi K.; Sei, Y. *J. Chromatogr. B* **2006**, *874* (102), 64-76.
33. Bowsher, R.R.; Santa, P.G. *J. Chromatogr. B* **2009**, *877* (8-9), 689-696.
34. Zhou, W.; Bi, J.; Janson, J.-C.; Li, U.; Huang, Y.; Zhang, U.; Su, Z. *J. Chromatogr. B* **2006**, *838* (2), 71-77.
35. Svensson, J.-O.; Barkholt, L.; Sawe, J.; *J. Chromatogr. B* **1997**, *690* (1-2), 363-366.
36. Pagel, P.; Schubert, R.; Wolf, H.W. *J. Chromatogr. B* **2000**, *746*, 283-295.
37. Zolotarjova, N.; Mrozinski, P.; Majors, R.E. *LCGC No. America* **2007**, *25* (2), 118-140.
38. Martosella, J.; Zolotarjova, N.; Liu, H.; Nicol, G.; Boyes, B.E.; *J. Proteome Res* **2005**, *4* (5), 1522-1537.
39. Zhang, K.; Zolotarjova, N.; Nicol, G.; Martosella, J.; Yang, L.-S.; Czafanski, C.; Bailey, J.; Boyes, B. *Agilent Multiple Affinity Removal System for the Depletion of High-Abundant Proteins in Human Serum – A New Technology from Agilent*, Agilent Application Note #5988-9813EN, **2003**.
40. Brand, J.; Haslberger, T.; Zolg, W.; Pestlin, G.; Palme, S. *Proteomics* **2006**, *6*, 3236-3242.
41. Shen, Z.; Want, E.J.; Chen, W.; Keating, W.; Nussbaumer, W.; Moore, R.; Gentle, T.M.; Siuzdak, G. *J. Proteome Res.* **2006**, *5*, 3154-3160.
42. Chang, M. *Automated Sample Preparation by Protein Precipitation for High-Throughput Bioanalysis*, Agilent Technologies Application Note #5990-9030EN, **September, 2011**.
43. Yu C.; Cohen, L.H. *LCGC No. America* **2003**, *21* (11), 1038-1048.
44. Barker, S.A.; Long, A.R.; Short, C.R. *J. Chromatogr.* **1989**, *475*, 353-361.
45. Barker, S.A. LCGC, *Current Trends and Developments in Sample Preparation* **May, 1998**, S37-S40.
46. Lagana, A.; Bacaloni, A.; Castellano, M.; Curini, R.; De Leva, I.; Faberi, A.; Materazzi, S. *J.A.O.A.C.* **2003**, *86* (4), 729-736.
47. Posyniak, A.; Zmudzki, J.; Semeniuk, S. *J. Chromatogr. A* **2001**, *914*, 89-94.
48. Yu, C.; Penn, L.D.; Hollembaek, J.; Li, W.; Cohen, L.H. *Proc. 51st Annual Conference American Society of Mass Spectrometry and Allied Topics, ThPM 257*, **2003**.
49. Draisci, R.; Marchiafava, C.; Palleschi, L.; Cammarata, P.; Cavalli, S. *J. Chromatogr. B* **2001**, *753*, 217-223.
50. Schumacher, R.T.; Manak, M.; Gerret, P.; Miller, W.; Lawrence, N.; Feng, T. *American Laboratory* **2002**, *34* (16), 38-44.

# Sample Pre-treatment for LC/MS

Mass spectroscopy is considered to be a high resolution, sensitive detection technique due to its specificity and low limits of detection. Proper sample preparation and HPLC operation can ensure that it will deliver the highest level of qualitative and quantitative compound measurement. Each year, mass spectrometers become even more sensitive, bringing about better answers to pressing problems in its applications areas, but an additional burden is placed on the quality of the effluent coming into the source. Although the sample pre-treatment step takes place prior to HPLC detection, there are requirements to present the sample to the liquid chromatograph that permits a mass spectrometer to provide its highest level of performance. Sample preparation is an integral, but sometimes neglected part, of a successful mass spectrometric experiment. The widespread adoption of LC-MS/MS as a major technique for bioanalysis, proteomics, food safety, and other markets requiring high sensitivity and high-throughput analysis originally led to a de-emphasis on the importance of sample preparation. At one time, it was believed that the sample prep/chromatography step could be dispensed with! It is naive to assume that the MS alone will be able to solve all separation problems, but it is better that the systems work in harmony and that one understands where sample preparation can aid in providing better mass spectra. Thus, observation of unseen "matrix" effects in LC/MS and LC-MS/MS has led researchers to rethink the importance of sample preparation in successful use of this powerful technique.

The highest level of uncertainty associated with an LC/MS method will likely come from the sample matrix since it may contain every known type of interference. Among the factors that the sample and its matrix (as well as the mobile phase) can affect are:

- Spectral interference
- System compromise
- Adduct formation
- Ion suppression

Sample interferences must be identified, removed, reduced – or at a minimum accounted for – in the LC/MS method.

**Spectral interference:** Ions that appear at the same or nearly the same  $m/z$  value as the component of interest can cause spectral interference. Ions of similar  $m/z$  value can generally be separated by the chromatographic process prior to entering the MS. In situations in which it is impossible to separate the ions first, say on a lower resolution MS system and very complex samples and matrices, analysts can use multiple reaction monitoring (MRM) with an MS-MS system to make a clear distinction between the ions. The MS systems using a time-of-flight analyzer are generally able to distinguish much better than unit mass resolution and, therefore, can pull apart spectral peaks that overlap in lower resolution systems. Thus, the use of lower resolution MS systems will invariably need better sample cleanup than higher resolution MS systems that can distinguish between compounds with very close  $m/z$  values.

**System compromise:** Mobile phase components – or sample components that degrade the performance of the LC/MS system – generally through precipitation in the LC/MS interface, can compromise the system. The components that are most likely to precipitate in the atmospheric-pressure- or electrospray-ionization source are buffer salts and ion pair reagents. Substituting volatile buffers or simply adjusting the pH with a volatile acid such as formic acid or base such as ammonium hydroxide will solve this problem. Trifluoroacetic acid (TFA) is a popular HPLC mobile phase additive for peptide and protein separations since it gives excellent peak shape. However, it is notorious for causing ion pairing interactions and many workers prefer to use formic acid for a better MS signal intensity at the expense of poorer chromatographic peak shape. Sample matrix elements such as proteins can also precipitate in the source. Proteins can be removed by precipitation, dialysis, SPE, size exclusion chromatography, immunoaffinity, and other approaches (see Chapter 16, *Protein Removal*). Lipids, particularly phospholipids, can cause havoc in the mass spectrometer; new titania and other SPE sorbents can specifically remove these culprits (see Chapters 9, 10, and 16). In MS-MS using MRM, a signal at  $m/e$  of 184 usually indicates phospholipid contamination and it is a good idea, if they can't be removed by sample preparation techniques, to chromatographically resolve these compounds from your analyte peaks.

Thus, using the techniques described in **Table 15.1** to remove matrix interferences such as salts, ion pair reagents, and proteins may help to keep the ion source clean and contaminant-free. Some of the new orthogonal ionization sources can tolerate some buildup of contaminants, but nevertheless it is wise to remove undesired components before passing them into the MS source.

**Adduct formation:** Adduction of another ion with the component of interest shifts the  $m/z$  value at which the component of interest appears in the spectrum. Adduct ions such as sodium, potassium, and ammonium can be picked up from the sample itself, from reagents, or even from the container holding the sample. Sodium ions from sodium borosilicate glassware is an example of the latter. Adduct formation can be used as a way to improve signals for macromolecules. However, uncontrolled adduct formation generally is undesirable and requires specific sample preparation procedures to reduce or eliminate it. Techniques for the removal of ions were covered previously in **Table 15.1**.

**Ion suppression/ion enhancement:** Unextracted matrix compounds may co-elute with the analytes of interest and end up in the ionization chamber of the mass spectrometer. Ion suppression is the result of those components that suppress the ionization of or compete in the ionization process with the component of interest. It results from the presence of less volatile compounds that can change the efficiency of droplet formation or droplet evaporation, which in turn affects the amount of charged ion in the gas phase that ultimately reaches the detector. Ion suppression is the most critical of these interferences because it is often the most difficult to determine. Even components that do not appear in the mass spectrum can cause ion suppression. The electrospray detector is strongly affected by the presence of certain co-eluting compounds. Ion suppression effects are most noticeable when trace analytes are in the presence of complex matrices such as biological fluids. Besides complex buffers and detergent systems commonly used in biological samples, materials shown to cause ion suppression include salts, ion pairing reagents, endogenous compounds such as lipids, sugars, and nucleic acids, as well as drugs, metabolites, and proteins. In biological samples, natural variation in endogenous compound concentrations from one sample to another can cause varying levels of ion suppression. The variation in turn contributes to unacceptable variability in the signal response for the compounds of interest. Most often a loss in response occurs; hence the term *ion suppression* is generally used. Ion suppression effects impact reproducibility and signal strength. In some cases, an increasing response of the desired analyte may occur; *ion enhancement* or a stronger-than-expected signal results. Atmospheric pressure chemical ionization detectors are also affected by ion suppression, but to a lesser extent than the electrospray detector. However, for both qualitative and quantitative LC/MS work with API interfaces, understanding and eliminating ion suppression and enhancement effects is essential.

The presence of ion suppression can be determined by the use of infusion. The infusion experiment involves the continuous introduction of the standard solution containing the analyte of interest and its internal standard by means of the syringe pump connected to the column. After injecting a blank sample extract into the LC system, a drop in constant baseline indicates suppression in ionization of the analyte due to the presence of the interfering material.

Although beyond the scope of this chapter, there are a number of strategies for reducing ion suppression. Among them are changing the ionization mode, such as switching from positive ionization to negative ionization, sample dilution or volume reduction, reducing the flow rate, improving chromatographic selectivity, or performing better sample preparation. In the latter case, many of the sample prep techniques covered in this book, such as SPE or liquid-liquid extraction, or even additional techniques may be required to provide the best possible spectral data. The use of formic acid, rather than trifluoroacetic acid, in the HPLC mobile phase can also help. For more information, a simple discussion of ion suppression effects and their elimination was published earlier<sup>1</sup>. For further information on sample preparation for LC/MS and LC-MS/MS, a review article<sup>2</sup>, a textbook<sup>3</sup>, and LC/MS textbooks<sup>3-10</sup> are available.

The most common ions formed in API/MS are protonated molecules, symbolized  $[M+H]^+$ . Similarly, deprotonated molecules,  $[M-H]^-$ , may be seen in negative ion operation. Formation of these molecules takes place through ion evaporation in electrospray and through gas-phase chemical ionization in APCI. Understanding these reactions is the basis for understanding the origin of ion suppression effects. In positive ion operation, the gas phase ion-molecule reactions will result in formation of the weakest acid, i.e. the weakest proton donor. For example, in the APCI analysis of the amine  $R-NH_2$ , water is a stronger proton donor than the amine and therefore readily gives up its proton from  $H_3O^+$  to form the  $R-NH_3^+$  ion. However, if we now introduce a large amount of another compound which can form an even weaker acid than the analyte (e.g.  $R_3N$ ), then the gas-phase reaction will continue on to form  $R_3NH^+$ , the weaker acid. The  $R-NH_2$  analyte will not be ionized or will be poorly ionized, and therefore not seen at significant levels in the mass spectrum. These same types of proton transfer reactions can take place in electrospray interfaces. An analogous model can be developed for negative ion operation where the weakest proton acceptor (weakest base), is formed.

Another type of ion suppression is thought to occur when very strong ion pairs are formed which are not broken apart by the conditions in the API interface. Ion pairing agents of various types have been shown to contribute to ion suppression and therefore their use in LC/MS should be avoided where possible.

The bottom line is that proper sample preparation can improve the performance for LC/MS despite the higher level of resolution that this detection technique brings to the analysis. The increasing levels of sensitivity and selectivity in modern mass spectrometry, especially the tandem techniques, have had a profound effect on analysis in both the gas and liquid phase. For more information, the reader is directed to Chapter 21, which addresses the balancing of achieving selectivity in analysis (separation and detection) and introduces the concept of "Just Enough" sample preparation.



# Solvents and Volatile Buffers Used in Mass Spectrometry

Although sample preparation precedes chromatographic separation, it is important to understand which solvents and buffers may be used in sample prep techniques, since – unless exchanged or removed – these additives may be injected into the LC/MS system and may impact the ionization of analytes of interest. **Tables 17.1** and **17.2** provide a listing of solvents and volatile buffers compatible with MS, respectively. Non-volatile buffers should be avoided since they may foul inlet systems and cause problems with MS sources. Normal concentration ranges for buffers should be 1-10 mM.

Although TFA is very useful as an HPLC mobile phase additive providing excellent peak shapes for basic compounds, it is known to suppress ionization in electrospray LC/MS, leading to lower sensitivity, and should be avoided. Formic acid is a better alternative.

Table 17.1

Typical LC/MS Solvents				
Solvent	Formula	MW (Da)	Boiling Point (°C)	UV Cutoff (nm)
Acetonitrile	CH <sub>3</sub> CN	41.05	81.6	190
Chloroform	CHCl <sub>3</sub>	119.38	61.7	245
Dichloromethane	CH <sub>2</sub> Cl <sub>2</sub>	84.93	40.0	235
Ethanol	CH <sub>3</sub> CH <sub>2</sub> OH	46.08	78.5	210
Ethyl acetate	CH <sub>3</sub> CO <sub>2</sub> CH <sub>2</sub> CH <sub>3</sub>	88.12	77.1	260
Diethyl ether	(CH <sub>3</sub> CH <sub>2</sub> ) <sub>2</sub> O	74.12	34.5	220
Heptane	CH <sub>3</sub> (CH <sub>2</sub> ) <sub>5</sub> CH <sub>3</sub>	100.21	98.4	200
Hexane	CH <sub>3</sub> (CH <sub>2</sub> ) <sub>4</sub> CH <sub>3</sub>	86.18	69	200
Isopropanol	CH <sub>3</sub> CH(OH)CH <sub>3</sub>	60.11	82.4	210
Methanol	CH <sub>3</sub> OH	32.04	65	205
n-Propanol	CH <sub>3</sub> CH <sub>2</sub> CH <sub>2</sub> OH	60.11	97.4	210
Tetrahydrofuran	C <sub>4</sub> H <sub>8</sub> O	72.12	66	215
Toluene	C <sub>6</sub> H <sub>5</sub> (CH <sub>3</sub> )	92.15	110.6	285
Water	H <sub>2</sub> O	18.02	100	none

Table 17.2

Typical LC/MS Volatile Buffers			
Volatile Buffer	Structure	pKa	Buffer Range
Trifluoroacetic acid	$\text{CF}_3\text{CO}_2\text{H}$	0.5	3.8-5.8
Formic acid	$\text{HCO}_2\text{H}$	3.8	–
Ammonium formate	$\text{HCO}_2\text{NH}_4$	3.8	2.8-4.8
Acetic acid	$\text{CH}_3\text{CO}_2\text{H}$	4.8	–
Ammonium acetate	$\text{CH}_3\text{CO}_2\text{NH}_4$	4.8	3.8-5.8
Propionic acid	$\text{CH}_3\text{CH}_2\text{CO}_2\text{H}$	4.9	3.9-5.9
4-Methylmorpholine	$\text{OC}_4\text{H}_8\text{N}(\text{CH}_3)$	8.4	7.4-9.4
Ammonium bicarbonate	$\text{NH}_4\text{CO}_3\text{H}$	6.3/9.2/10.3	6.8-11.3
Ammonium acetate	$\text{CH}_3\text{CO}_2\text{NH}_4$	9.2	8.2-10.2
Ammonium formate	$\text{HCO}_2\text{NH}_4$	9.2	8.2-10.2
1-Methylpiperidine	$\text{C}_5\text{H}_{10}\text{N}(\text{CH}_3)$	10.1	10.0-12.0
Diethylamine	$\text{NH}_2\text{CH}_2\text{CH}_2\text{NH}_2$	10.5	9.5-11.5
Triethylammonium acetate	$\text{CH}_3\text{CO}_2\text{NH}(\text{CH}_3)_3$	11.0	10.0-12.0
Pyrrolidine	$\text{C}_4\text{H}_8\text{NH}$	11.3	10.3-12.3

# Small Molecules in Biological Matrices

An area of popular use of LC/MS and LC-MS/MS is in new drug discovery, where small molecules such as drugs and their metabolites are separated and identified in biological fluids. As mentioned earlier, the analytical challenge is to be able to achieve good qualitative and quantitative analysis in the presence of endogenous compounds, which may affect the MS signals due to ion suppression. Many of the methods that we have discussed throughout the book can be used to eliminate or reduce undesirable interferences from plasma, urine, CSF, etc.

The traditional method for extracting drugs from biological fluids is liquid-liquid extraction (LLE, Chapter 7). With proper method design, LLE can be very selective and result in very clean extracts. Some degree of automation is possible, more recently using supported liquid extraction in 96-well plates, but generally LLE has been a manual or semi-manual procedure. In recent years, solid phase extraction (SPE) has grown to become as widely used as LLE. For plasma and other biological samples, experimental design usually calls for retention of the drug/metabolite on the SPE phase while the proteins and other endogenous components are washed out. The drugs/metabolites (and impurities retained on the sorbent) are washed off with a different solvent in a second elution step. SPE has considerable advantages over LLE in terms of sample size required, the amount of solvent used, and most importantly, the ability to be used in fully automated, on-line systems. Many of these systems use the same 96-well format plates. Compared to LLE, SPE requires more steps in developing and optimizing an SPE method. For biological fluids, if a method is properly developed and optimized, SPE extracts are usually as clean as LLE extracts, but selectivity may be limited unless a selective phase can be found and fines/particulates from the extraction column may plug the LC column or MS interface, although this is less of a problem today than a decade or two ago. Protein precipitation has become popular since it requires less method development than either LLE or SPE, but the extracts are not as clean as these time-tested techniques. However, as long as ion suppression is minimized for analytes of interest by having good chromatography, LC-MS/MS of protein-precipitated extracts provides decent qualitative and quantitative analysis.

The most recent advance in SPE phases has been the creation of mixed mode sorbents, both silica- and polymer-based. Development of materials which exhibit hydrophobic and hydrophilic character are driven by the demand for a “universal” SPE phase which can be used with one or a few extraction methods for a wide variety of compounds. Polymeric sorbents in this category are able to withstand pH ranges from 1-14, and this – along with their bimodal character – provides a flexible platform for extraction of acidic, basic, and neutral drug compounds from plasma, serum, and urine using generic methods.

Reversed-phase SPE has generally shown poor recovery for some basic drugs that may bind to residual silanols in the silica. The mixed hydrophobic/SCX (strong cation exchange) phases have been developed to address this problem. Both polymeric- and silica-sorbents are available with varying alkyl chain lengths and with sulfonic SCX groups. It is postulated that the drug compound and other hydrophobic excipients are initially loaded onto the alkyl portion of the phase while highly water-soluble compounds are washed off. Aqueous/organic wash is then used to remove the hydrophobic interferences and move the drug and metabolite compounds onto the strong cation exchanger. Finally, a very clean basic drug extract is eluted with methanol/ammonium hydroxide.

In the quest for even higher throughput, the natural direction for investigators to go is toward direct injection of biological fluids. Two approaches that have arisen in this are: restricted access media (RAM, see Chapter 10) and turbulent flow chromatography<sup>10</sup>. Many restricted access media chemistries are bimodal, like the sorbents described above. The mechanism of restricted access depends on excluding macromolecules from the retentive surface of the SPE particle either by physical or chemical means or a combination of the two. Essentially, restricted access media allow small molecules to penetrate the pores in the particles and therefore come in contact with the reversed-phase portion of the sorbent where they are retained. Macromolecules such as serum proteins are excluded from the pores and remain in the external portion of the phase, which has a biocompatible or hydrophilic chemistry. Proteins are not denatured or retained by this portion of the sorbent and are therefore washed out with a high aqueous solvent in the solvent front. To prevent the proteins from being directed to the HPLC column, column switching (see Chapter 13) is used to direct them to waste. The small molecules of interest are then eluted from the RAM with increasing amounts of strong solvent.

Turbulent flow chromatography is a technique requiring a special column to which sample is applied at high flow rates of 4-8 mL/min of water<sup>11</sup>. Small molecules are retained on the column, and at these high linear velocities, plasma components are washed off to waste. Flow is then switched to an aqueous/organic elution solvent and compounds of interest are eluted into the MS interface. The high flow rates allow for very rapid analyses.

Both restricted access and turbulent flow columns may be used by themselves for direct elution into the MS interface or in LC/LC mode where analytes are re-focused on an analytical HPLC column prior to the MS. This latter mode of operation is reported to be more favorable for complex, multi-component samples since the sample preparation columns generally exhibit low efficiency and are not capable of adequate separation of complex mixtures.

The SPE applications discussed to this point have been packed column applications. Of course, disk format SPE and solid phase microextraction (SPME) are also applicable to analysis of drugs in biological fluids. Disks of glass fiber, PTFE, and polyvinyl chloride have been applied to SPE. Small diameter ( $\sim 10 \mu\text{m}$ ) sorbent bonded phase particles are impregnated into the disk or the disk material itself is derivatized. Small diameter particles have also been applied to packed bed formats to improve mass transfer efficiency. Disks offer the advantage of greatly increased surface area of sorbent coupled with far less non-specific adsorption than typical packed columns. Disk formats therefore require less sample to be applied, smaller volumes of solvent used, and fewer steps to clean up unwanted compounds. Very high effective flow rates through the disk also save time. Low volumes are compatible with micro-LC and small diameter disks are quite amenable to 96-well plate format used in many current automation systems.

SPME (see Chapter 10) has been applied to GC and GC/MS analysis for years and has also been adapted to use with HPLC. SPME relies on a solid phase sorbent coated to the outside of a fiber which is then introduced directly to the sample and allowed to extract analyte. Compounds of interest are subsequently washed off in the same manner as standard SPE. SPME fibers will only adsorb about 20% of the analyte in the sample, but will inject this entire amount into the chromatograph. This is by comparison with standard SPE, which may adsorb 90% of the analyte available, but without a preconcentration step, will only inject a few percent of that amount.

The "in-tube" SPME for LC/MS has been applied to the analysis of drugs in urine and serum (see Chapter 10). This method uses an open tubular GC capillary in the place of the fiber. A small volume, on the order of  $30 \mu\text{L}$  of filtered serum sample, is repeatedly drawn back and forth through the capillary, allowing drugs to extract into the stationary phase. The capillary is then switched in-line with the LC mobile phase and LC/MS analysis of the desorbed drugs proceeds. The "in-tube" procedure for LC-SPME is low-cost and easily automated. Good recoveries and LOQs have been demonstrated for the low *in vivo* concentration levels of  $\beta$ -blocker drugs and metabolites evaluated.

Immunoaffinity sorbents (see Chapter 10) have also received considerable attention in the LC/MS community. These sorbents are based on immobilized antibodies which retain compounds of interest by molecular recognition. Subsequent denaturation of the antibodies releases the analyte. The "classic" affinity column is based on Sepharose, which is not compatible with the high pressures or flow rates needed for on-line automation of LC/MS. However, HEMA (polyhydroxyethyl methacrylate) supports, which are more capable of withstanding HPLC conditions, have been used. Affinity techniques have recently come into use for environmental analysis where small amounts of pollutants, e.g. pesticides, are specifically isolated from moderate to small sample volumes. Similarly, the technique has been applied to determine drugs that occur at low levels in biological fluids.

MS/MS has become a well-accepted technique for determination of low levels of drugs and metabolites in biological fluids. MS/MS has the advantage of excellent sensitivity for quantitation (especially with triple quadrupole instruments), excellent throughput, and very high specificity. In procedures called selective reaction monitoring (SRM) and multiple reaction monitoring (MRM), an ion (or ions) can be selected in the second stage of MS, which is characteristic of the analyte(s) only.

The second stage of MS is another stage of separation and therefore may allow a somewhat "dirtier" initial sample to be introduced. If the analyte co-elutes with another compound which produces ions of the same  $m/z$  value, selection of this ion for subsequent MS/MS will often result in production of a fragment ion which is characteristic of the analyte, but not the co-eluting interferent. This fragment ion is then used for quantitation and qualitative confirmation of identity.

MS/MS however is not an *ionization* technique. Its advantages begin after ion formation. Therefore, MS/MS users must still be concerned with ion suppression and components such as salts, which may compromise system performance. In addition, adduct formation will not be prevented by the use of MS/MS. However, the complexity of interpreting an adduct ion spectrum may be reduced if all adduct ions produce a common fragment ion. A full scan of the spectrum in the initial stage of MS will capture all adduct ions for fragmentation and analysis by the second mass analyzer. The second MS may then be set to pass only the characteristic fragment ion.

# Biological Macromolecules

The development of electrospray LC/MS interfaces, which are capable of putting large macromolecules into the MS, has had a tremendous impact on the study of proteins and nucleic acids. Molecular weight determinations, sequence, and structural information are available directly from electrospray MS spectra. It is beyond the scope of this chapter to describe these applications but references are available<sup>3-9</sup>.

During method development for intact biological macromolecules, the same concerns about interferences discussed for small molecule applications must be considered. However, at this time, laboratories are not so concerned with putting thousands of samples through in a day as are the labs working on new drug discovery. Instead, these workers are more concerned with complete characterization of the molecule, often from very small amounts of starting material. Therefore, sample preparation methods must show good recoveries and deliver clean extracts. Micro sample preparation methods coupled to Micro-LC or CE are required in many cases. Studies on biomarkers for cancer and other diseases and evaluation of peptide fragments from enzymatically-degraded proteins are other areas where LC/MS and LC-MS/MS are widely used. Chapter 15 provided examples of these types of applications.

For protein analysis (see Chapter 15), traditional purification procedures are often used prior to LC/MS analysis. Hydrophobic interaction chromatography, size exclusion, ultrafiltration, and HPLC have all been used to separate proteins for analysis. SPE methods on reversed-phase and ion exchange sorbents are widely used and give good cleanup, especially for removal of salts and buffers, which contribute to ion suppression effects and adduct formation. Naturally, many SPE and chromatographic procedures have the potential for on-line, automated operation.

While not strictly a "sample preparation" issue, certain mobile phase components must also be considered when developing LC/MS methods for biomolecules. The same concerns for non-volatile buffer salts and ion pairing agents, described earlier, is one consideration. Another is ion suppression problems encountered in use of trifluoroacetic acid (TFA) in peptide/protein analysis by electrospray. TFA is thought to improve peak shape in reversed-phase chromatography of peptides by ion-pairing with basic sites on the molecule thereby eliminating mixed retention mechanisms. However, TFA-Peptide ion pairs are not broken up in the interface and this prevents ionization of the protein. The problem can be reduced by limiting the concentration of TFA to under 0.1% or using "TFA light", which is a reduced amount of TFA – perhaps 0.05% – and the same concentration of acetic acid. This serves to control pH and promote protein ionization, as required for electrospray, without forming an abundance of ion pairs. The LC peak shape for the peptides will be degraded, but this may not adversely affect the mass spectra. In some cases, however, preservation of the LC peak shape and separation may be necessary and the amount of mobile phase TFA cannot be reduced. For these instances, a post column modification of the mobile phase is needed. A mixing tee is placed after the HPLC column, which allows a small pump to be used to add solvent to the mobile phase prior to its entry into the MS interface. The "TFA Fix" involves pumping in 20% propionic acid in isopropanol at about half the flow rate from the column. It is believed that in the gas phase of the API interface, the propionic acid replaces the TFA in the ion pair and this pair subsequently breaks down, freeing the analyte ion.

Adduct formation in both proteins and nucleic acids can seriously compromise the utility of the mass spectrum by spreading the total ion current over numerous peaks arising from  $[M + nX]n^+$ . "X" is usually  $\text{Na}^+$  and  $\text{K}^+$  ions, which readily form adducts and are present in the chemical environment from glassware, high purity solvents, and even solid phase sorbent media. Reversed-phase SPE or HPLC generally works well for removing the highly water soluble salts prior to introduction into the MS. Cation exchange and precipitation procedures have also been applied for desalting. For oligonucleotides, addition of a strong base such as piperidine reduces sodium adduct signals.

These types of cleanup procedures require relatively large amounts of sample. This can be a problem in biotechnology research, particularly for polynucleotides in which cation adduction increases considerably with molecular weight limiting both sensitivity and the size of molecule that can be analyzed. An approach to this problem is an on-line, microdialysis system that effectively eliminates cation formation<sup>10</sup>. The aqueous dialysis buffer has the additional benefit of maintaining the biopolymers in their native conformation.

Among the most widely used protein separation technique is two-dimensional gel electrophoresis (see Chapter 15). Complex mixtures of proteins are first separated on a polyacrylamide gel on the basis of their isoelectric point and then separated at 90° to the initial separation direction on the basis of molecular size in the presence of a denaturing detergent (usually sodium dodecylsulfate, SDS). Finally, proteins are visualized with an in-gel staining procedure. Upwards of 1,000 protein "spots" may be separated on a standard gel.

SDS-PAGE can determine protein molecular weight to within 5-10% accuracy. Modern electrospray-TOF mass spectrometry can determine protein molecular weights to within 100 ppm, which often translates to < 1 Da accuracy. Furthermore, MS can tell us about the sequence, cystine crosslinkages, location and type of post-translational modifications, or tertiary structure of the protein. Therefore, removing proteins from gels for LC/MS analysis has been one focus of protein researchers.

It is essential to remove the SDS detergent and the stain from the protein prior to MS analysis or severe ion suppression and interference problems will arise. Procedures for electroblotting of proteins from gels onto membranes and extraction directly from the gel have been described. Gel separated proteins are further prepared by enzymatic cleavage with, for example, trypsin. The "mass maps" subsequently generated by LC/MS analysis can be submitted to databases for identification of the native protein. MS can also be used to determine primary sequence of unknown peptide fragments.

An MS tool for protein analysis is nanoelectrospray, a very low volume, low flow version of electrospray in which sample can be infused to the MS for long periods of time to obtain very high S/N values and consequently low detection limits, high m/z accuracy, and high resolution. In a further example of the blurring of the line between chromatography and sample preparation, a nano LC column is placed directly in line with the capillary inlet to the nanoelectrospray system. Both strong solvent elution of all proteins at once and gradient elution to provide some degree of initial separation are possible. Using an immobilized trypsin "micro-digestion" column in line with nanoelectrospray allows for production of MS tryptic maps without the off-line digestion step. Both of these methods are highly automatable and yield femtomole detection limits.



## Conclusion

LC/MS and LC-MS/MS are powerful tools that have seen an increased use in all areas of analytical chemistry. This impact is being seen particularly in the analysis of samples from biological matrices. To optimize the data obtained from these analyses, it is essential for the analyst to understand and deal with mass spectral interferences arising from the sample itself, the mobile phase, or the environment. Fortunately, chemists today have a wide variety of sample preparation strategies available to them to deal with these issues. Today, when designing a sample prep-liquid chromatography-mass spectrometry system, one must think about the entire workflow and use methodology that eliminates possible contaminants such as polyethylene glycol (PEG)-based detergents or non-volatile salts early in the planning.

Newer, more efficient, and more highly automated sample prep procedures for LC/MS and LC-MS/MS are the topic of vigorous research. As these new automated procedures come to market, the distinction between that part of the analysis called "chromatographic separation" and the part termed "sample preparation" will become less important and will be replaced with a concept of complete LC/MS system integration. Solid phase extraction will continue to grow in importance because of its similarity to HPLC and the very high degree of automation possible with the technique. Paralleling this development will continue miniaturization of the entire analytical system, including sample preparation, perhaps to chip-based, microfluidic formats. Techniques such as SPME, microdialysis, and nano LC lend themselves very well to the "instrument-on-a-chip" concept in which a micro autoinjector will be integrated with a sample preparation technology, chromatographic column, and MS capillary interface in a single micro-machined device which attaches directly to an API-MS instrument optimized for sub-microliter flow rates and sample volumes.

## References

---

1. Klink, F. *LCGC* **1999**, *17* (12), 1084-1093.
2. Hess, S. *Current Trends in Mass Spectrometry, Supplement to LCGC No. America* **July, 2013**, 12-17.
3. Ivanov, A.R.; Lazarev, A.V. *Sample Preparation in Biological Mass Spectrometry*, Springer, New York, **2011**, ISBN 978-94-007-0758-0 and e-ISBN 978-94-007-0828-0.
4. Urban, J.; Vanek, J.; Stys, D. *Systems Theory: in Liquid Chromatography – Mass Spectrometry*, LAP LAMBERT Academic Publishing, Saarbruecken, Germany, **2012**, ISBN-10: 3659298166 and ISBN-13: 978-3659298165.
5. Lipton, M.S.; Pasa-Tolic, L. *Mass Spectrometry of Proteins and Peptides: Methods and Protocols*, 2nd Ed., Humana Press, New York, **2009**, ISBN-10: 1934115487 and ISBN-13: 978-1934115480.
6. Ferrer, I.; Thurman, E.M. *Liquid Chromatography/Mass Spectrometry, MS/MS and Time of Flight MS: Analysis of Emerging Contaminants*, American Chemical Society, Washington, D.C., **2003**, ISBN-10: 0841238251 and ISBN-13: 978-0841238251.
7. Brown, M.A. *Liquid Chromatography/Mass Spectrometry: Applications in Agricultural, Pharmaceutical, and Environmental Chemistry*, American Chemical Society, Washington, D.C., **1989**, ISBN-10: 0841217408 and ISBN-13: 978-0841217409.
8. Niessen, W. M.A. *Liquid Chromatography-Mass Spectrometry*, 3rd Ed., CRC Press, New York, **2006**, ISBN-10: 0824740823 and ISBN-13: 978-0824740825.
9. Ardrey, R.E. *Liquid Chromatography – Mass Spectrometry: An Introduction*, Wiley, Chichester, W. Essex, U.K., **2003**, ISBN-10: 0471498017 and ISBN-13: 978-0471498018.
10. Sparkman, O.D.; Klink, F.E. *Liquid Chromatography Mass Spectrometry Fundamentals and Applications – An ACS Short Course*, American Chemical Society, Washington, D.C., **1999**.
11. Herman, J.L.; Edge, T. *LCGC No. America* **2012**, *30* (3), 200-214.

# Membrane Techniques in Sample Preparation

Membranes are usually made from synthetic polymers (e.g., PTFE, nylon, or polyvinylchloride), cellulose, or glass fibers. Filtration (Chapter 5) and solid phase extraction (SPE) with disks (Chapter 9) represent major applications of membranes for sample preparation. In general, membrane separation techniques have not been widely used for other chromatographic sample preparation tasks. However, ultrafiltration, reverse osmosis, dialysis, microdialysis and electro-dialysis are examples of techniques that use membranes for concentration, purification, and separation of analytes, especially in the biological world.

## Dialysis and Membrane Sample Preparation

Microporous semi-permeable membranes allow the passage of certain compounds and not others. These membranes permit selective filtration because of the size of their micropores. For example, for separating large macromolecules such as proteins from small molecules (i.e. drugs or drug metabolites), dialysis uses a microporous, molecular-weight cutoff membrane<sup>1</sup> where proteins are unable to pass through the small pores, yet small molecules can do so easily. As indicated in **Figure 18.1**, the sample solution (donor) is placed on one side of the membrane; on the other side is a second liquid (acceptor). In some cases, interferences diffuse through the membrane, leaving a purified donor solution. More often, analyte passes through the membrane into the acceptor solution, leaving interferences in the donor solution. Migration of neutral small molecules through a semi-permeable membrane is a result of a difference in analyte concentration on the aqueous donor side of the membrane to the aqueous acceptor side of the membrane. Once the concentration becomes equalized, there is no further migration.

Dialysis is not characterized by selective small molecule analyte enrichment. There is only partial cleanup due to lack of a discrimination mechanism between other small molecules that may have the same size as the analyte molecules<sup>2,3</sup>. For this reason, dialysis is not regarded as an extraction technique per se, and often an additional sample cleanup step is included in the process. However, it has been widely applied to food and biological samples since macromolecules are excluded from passing through the pores of the membrane. It finds great use in desalting of biological solutions.

Thus, as implied in **Figure 18.1**, the successful application of membrane techniques for sample cleanup requires removal of analyte from the acceptor side by trapping (trace enrichment). If the analyte can undergo a change in its chemical state (e.g. change from an uncharged to a charged species), then it can continue to be enriched. An advantage of membrane separation techniques for RP-HPLC analysis is that both the donor and acceptor liquids are usually water or buffer. Membrane separations can be carried out in either a static or flowing system, with the latter more amenable to on-line automation.

Compared to SPE or LLE, membrane separations are slower and are less likely to enrich the analyte concentration in the sample by orders of magnitude. If no analyte enrichment takes place, the analyte remains in solution without any further concentration. Thus, detection limits may be compromised and further sample processing time is required in subsequent cleanup steps. Another danger with the use of membranes for the cleanup of dirty samples (e.g. wastewater) is that their pores may become fouled with debris (e.g. microparticulates, colloids, solids). Also, depending on the membrane's chemical composition, chemical interactions between the analytes of interest and the membrane itself may occur, thereby affecting recovery and method precision.

Most membrane techniques are not particularly suited to high-throughput sample preparation requirements. However, there has been a movement to adapting 96-well plate systems for membrane technologies. When evaluated on a per well (sample) basis, then membrane techniques can become more "throughput competitive" with other sample preparation techniques since all 96 samples can be processed simultaneously.

**Figure 18.1**

### **Schematic of a Membrane Operating in a Flowing System**

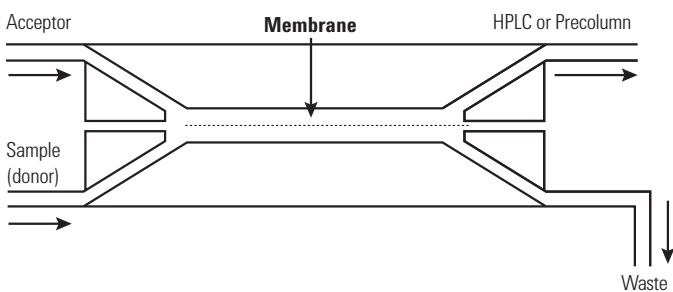

Membranes are produced in many forms: sheet, roll, disk, capsule, cartridge, spiral-wound and hollow fiber forms. In addition to differential concentration, analytes can also be moved across a membrane by diffusion as a result of chemical or electrochemical gradients. Porous, electrically charged, or ion exchange membranes have pore walls with fixed positive or negative charges. Separation characteristics of ionic molecules are governed by pore size and wall charge. The application of electrochemical forces adds another dimension to the membrane separation process (see later).

Microdialysis sampling, a specialized application of dialysis, uses small microprobes of fused silica tubing with a membrane at one end<sup>4</sup>. These probes can be implanted into living systems (e.g., rat brain), and the diffusion of small organic molecules through the membrane can be monitored on-line by HPLC without disturbing the animal or plant.

## Ultrafiltration

Ultrafiltration (UF) sampling is similar to dialysis and microdialysis, except that the driving force is flow through the membrane (with 300-300,000 mol wt cutoffs) is a result of a pressure differential (10-100 psi) applied across the membrane. As in the case of dialysis, small molecules collect on the acceptor side. UF membranes are available as self-contained, disposable devices for the hand processing of aqueous biological samples. UF separation is achieved by first pouring a sample into a filter cup and then capping and applying air or gas pressure through the top cap.

Concentrated proteins and other molecules greater than the cutoff rating are retained in the filter cup while water, salts, and low molecular-weight soluble components are collected in the filtrate collection cup. Ultrafiltration concentrates the sample without the need for harsh chemical conditions that could affect the biological activity of labile compounds like therapeutically active proteins. It also avoids the use of organic solvents and extreme pH conditions.

# Supported Liquid Membrane (SLM) Enrichment

SLM techniques<sup>5-7</sup> are similar to flow dialysis, except that a porous PTFE solvent-filled membrane separates the two aqueous solutions. The technique is actually a combination of dialysis and liquid-liquid extraction. Initially, the membrane is impregnated with a water-insoluble organic solvent (e.g., n-undecane) – termed the supported liquid – and is placed in a mounting block. The organic solvent is held in the pores of the membrane by capillary forces. Compounds are extracted from the donor side into the membrane as a function of their solubility in the supported liquid where they are then re-extracted from the membrane into the acceptor side.

A simple example (**Figure 18.2**) depicting the SLM technique is the extraction of an un-ionized carboxylic acid (RCOOH) from the donor side by first partitioning into the organic impregnated membrane. In a subsequent extraction from the membrane by a basic solution on the acceptor side, the acid is then ionized and thus cannot be re-extracted into the membrane nor transferred back into the donor side. Concentration factors of several hundred can be achieved by SLM extraction.

Figure 18.2

## Extraction of Organic Acid from Aqueous Sample

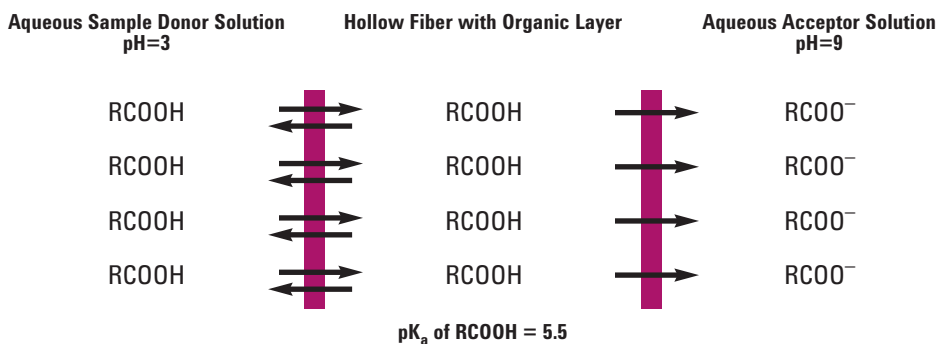

# Hollow Fiber Liquid Phase Microextraction (HF-LPME)

Instead of using a flat membrane fitted into a holder, an experimentally more convenient “holder” is the use of a hollow fiber. Hollow fibers are used in a wide variety of applications, the major one being their use for wastewater treatment; but in the laboratory, they are used for microfiltration and reverse osmosis. The hollow fibers (HF) are made of organic polymers such as polypropylene, polyethersulfone, polyester, and other materials, and can also be constructed from inorganic materials such as titania and zirconia. The HF are relatively inexpensive and can be considered to be single-use, and the materials are recyclable. Prior to use in any analytical application, the HF should be rinsed in acetone or other compatible solvent several times, then dried at room temperature.

The principle of static hollow fiber liquid phase microextraction (HF-LPME) is illustrated in **Figure 18.3**. There are some similarities to liquid phase microextraction (LPME) discussed in Chapter 7. However, in LPME, handling the “naked” drop at the needle tip poses some problems. Although the procedure itself is simple to operate, one needs to be careful since the drop can be unstable and the sample needs to be relatively clean. When the extracting “drop” is placed inside the lumen of a HF, it is mechanically protected against some of the physical problems that the suspended drop may encounter in LPME. Rather than the spherical configuration of a suspended drop in LPME, the HF-LPME provides a rod-like shape for the extracting solvent. The rod-like configuration increases the solvent surface area since the same volume of liquid in the surface area of a sphere is lower. The contact area between sample solution and the extracting solution is thus much more substantial than if the solvent were spherically shaped. The direct benefit of the change in solvent configuration is better extraction efficiency. Another significant benefit is that higher stirring speeds can be applied during the extraction procedure, since the solvent is protected by the hollow fiber and its stability is enhanced. In addition, the disposable nature of the hollow fiber eliminates the possibility of sample carryover and ensures high reproducibility; and the pores in the walls of hollow fiber cause it to show some selectivity by preventing the extraction of macromolecules, such as protein, particles, and so on from sample matrix. Therefore, HF-LPME is no longer just a preconcentration technique, it can provide sample cleanup, thus can be used for complex sample matrices.

Figure 18.3  
Schematic of HF-LPME Apparatus

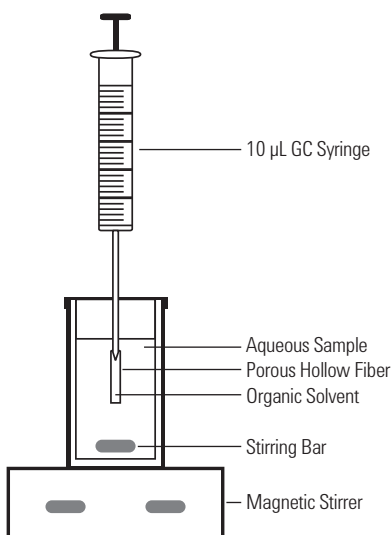
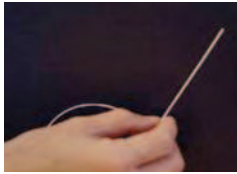

Figure 18.4

## Characteristics of Hollow Fiber Liquid Phase Microextraction



**Typical HF membrane characteristics:**

600  $\mu\text{m}$  lid x 200  $\mu\text{m}$  wall thickness, 0.2  $\mu\text{m}$  wall pore size

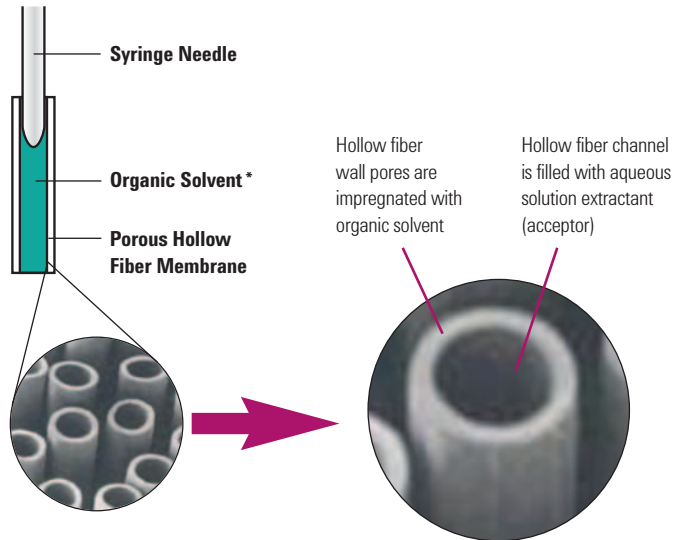

(courtesy of H.K. Lee, National University of Singapore)

\* Organic solvent is used as the acceptor phase in two-phase LPME. In three-phase HF-LPME, a second aqueous solvent is used as the acceptor phase (sometimes this technique is referred to as hollow fiber liquid-liquid-liquid phase microextraction or HF-LLME).



**Figure 18.4** shows the elements used to construct an HF extraction for HF-LPME. The selection of organic solvent used to fill in the pores of hollow fiber is a critical parameter in the success of the method. Similar to supported liquid membrane techniques, there are several requirements for the organic solvent. Firstly, it should be easily immobilized in the hollow fiber pores and non-volatile. Typically, hollow fibers used in most HF-LPME experiments are made of hydrophobic polypropylene. The solvent selected should have good affinity for the hollow fiber to prevent solvent loss during the extraction and to achieve stable solvent impregnation. Secondly, the solvent should be immiscible with water as it serves as a barrier to the aqueous sample. Lastly, the solubility of analyte of interest in the solvent should be higher than that in the aqueous sample matrix. Usually a relatively non-polar, high viscosity solvent will meet those requirements, and typical solvents used include 1-octanol, n-hexyl ether, undecane, toluene, etc. However, these relatively non-polar solvents usually have low solubility for the polar compounds, thus negatively impact the extraction efficiency for polar compounds.

Ionic liquids have been used as solvents for HF-LPME applications<sup>8-12</sup>. Ionic liquids are polar and non-volatile, but have been demonstrated to generate stable solvent impregnation. **Figure 18.5** shows scanning electron microscopic images of the inner surface of the hollow fiber before and after ionic liquid impregnation. By comparing the two photographs, it is obvious that the ionic liquid was immobilized in the hollow fiber pores effectively and an ionic liquid membrane for extraction formed. The advantages of using an ionic liquid as the extraction solvent include high affinity for polar compounds and compound-dependent selectivity. These specific features of ionic liquids have broadened the applications of HF-LPME to polar compound analysis.

Figure 18.5

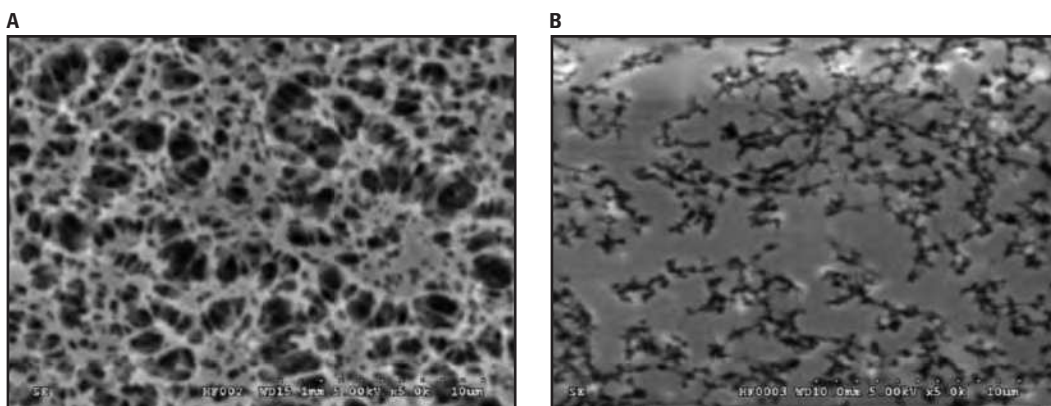

Scanning electron microscopic images of the inner surface of the hollow fiber magnified by 5000 times before (A) and after (B) ionic liquid impregnation<sup>13</sup>.

The HF-LPME procedure is simple and includes just a few steps. Prior to extraction, the hollow fiber (typically 1.5-10 cm in length, 200  $\mu\text{m}$  thick, 600  $\mu\text{m}$  id with a 0.2  $\mu\text{m}$  pore size), is closed on one end by flame-sealing. Next, it is soaked in the immiscible solvent that results in the immobilization of the solvent into the pores of the hollow fiber. The solvent forms a thin layer within the wall of the hollow fiber. A microsyringe is usually used to support the hollow fiber and also to introduce the acceptor phase into hollow fiber lumen. The hollow fiber is then placed into a sample vial filled with the aqueous sample, usually several milliliters (mL) in volume. To speed up the extraction, the sample is extensively stirred. The analytes are extracted from the aqueous sample through the solvent layer in the pores of the hollow fiber, then into the acceptor phase inside its lumen. After a certain time of extraction to achieve equilibrium (often in the range of 10-30 min), the acceptor phase is withdrawn into the microsyringe and then injected directly into the instrument for analysis.

Depending on the mode, the lumen of hollow fiber can be filled with several microliters of the same solvent (two-phase mode), or an aqueous acceptor phase (three-phase mode). In two-phase HF-LPME, organic solvent impregnated in the hollow fiber segment is exposed as a solvent rod in a stirred aqueous sample. Non-polar analytes in the aqueous sample can then be largely extracted through the hollow fiber into the acceptor solvent by diffusion. Since the solvent selected can be GC-amenable, the extracted sample can be directly injected into the gas chromatograph for analysis. Thus, the two-phase HF-LPME system using non-polar solvents as the acceptor phase is more suitable for relatively hydrophobic analyte extraction<sup>17-19</sup>. However, when using ionic liquids (ILs) as an acceptor phase, two-phase HF-LPME can be made more suitable for hydrophilic analyte extractions. Since ILs risk contamination of the column and require frequent cleaning of the injection port, they may not be GC-amenable, but can be injected into an HPLC system where the ionic liquid elutes quickly, thereby posing little or no interference possibilities with an HPLC reversed-phase chromatographic analysis.

The three-phase mode of hollow fiber liquid-liquid-liquid microextraction (HF-LLLME) is sometimes referred to as LPME with back extraction (LPME-BE). In this mode similar to the example cited in **Figure 18.2**, both donor and acceptor phases are aqueous-based, and the third solvent is an organic phase immobilized into the pores of hollow fiber that serves as a barrier to separate the two aqueous phases. During the extraction, the target analytes are extracted from the donor aqueous phase through the thin layer of organic solvent within hollow fiber wall and then into the acceptor aqueous phase. Since the acceptor phase is aqueous, the extracts can be analyzed by HPLC or CE. This method is usually applied for ionic or ionizable compounds, and mass transfer is driven by the differences between the donor and acceptor aqueous phases, such as pH adjustment, salting out effect in donor phase, or addition of proper acceptor reagent like ion-pair complexing reagent for analytes.

As the phase ratio between the donor phase (aqueous sample) and the acceptor phase (solvent or second aqueous phase) is very large ( $>100:1$ ), the analytes are concentrated significantly in the acceptor phase, with enrichment factors up to several hundred times. As a result, the detection limit of the analytical method is greatly improved by this high enrichment efficiency. Therefore, lower detection limit (lower ppb level or even sub-ppb level) can be easily achieved, even with relatively low sensitivity detectors, such as the UV detector.

To illustrate an application of a three-phase HF-LLLME technique, wastewater raw and spiked with polar phenols was studied<sup>14</sup>. Since the phenols were quite polar and have a significant solubility in water, they were not directly extractable from the water by an organic solvent. Therefore, in this example, an ionic liquid was impregnated into the HF. The ionic liquid consisted of a mixture of nonane and methylimidazolium hexafluorophosphate, BMIM[PF<sub>6</sub>]/acetonitrile (1:1) and provided a good extraction medium for the phenols. The acceptor phase was aqueous. The experimental setup of **Figure 18.3** was employed.

Using reversed-phase HPLC with UV detection to analyze the extracts, **Figure 18.6** provides a comparison of the HF-LLLME extractions of raw wastewater and the wastewater spiked at two levels (5 and 25 µg/L) with the four phenols to be analyzed. Clearly, the phenolic compounds could be extracted from the wastewater at these very low levels. The large peak at the beginning of the chromatograms was due to the ionic liquid eluting from the reversed-phase column near the void volume.

Figure 18.6

### Ionic Liquid HF-LLLME-HPLC-UV for Determination of Phenols

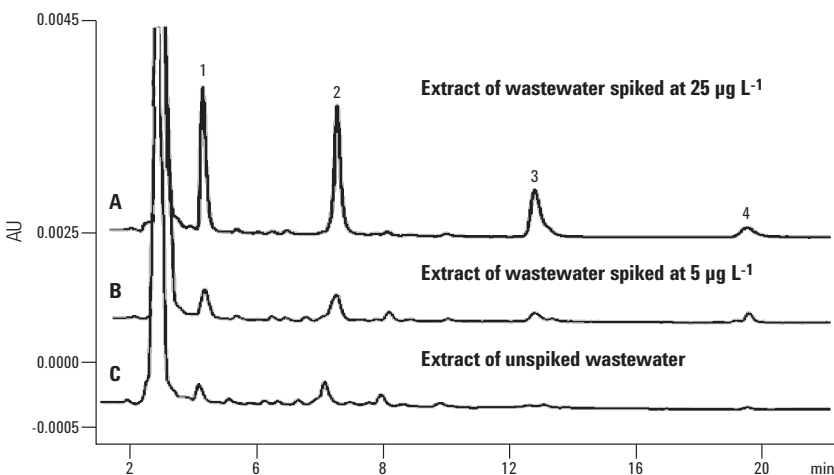

HF-LLLME, with nonane and [BMIM][PF<sub>6</sub>]/acetonitrile (1:1). HPLC-UV traces of wastewater extract. (A) Extract of wastewater spiked at 25 µg L<sup>-1</sup> of each phenol; (B) extract of wastewater spiked at 5 µg L<sup>-1</sup> of each phenol; (C) extract of real unspiked wastewater sample. Peaks: 1) 4-tert-butylphenol; 2) 4-tert-octylphenol; 3) 4-n-octylphenol; 4) 4-n-nonylphenol.

## Electromembrane Extraction (EME)

The concept of EME<sup>15</sup> combines the technical setup for hollow fiber liquid phase microextraction (HF-LPME)<sup>16,17</sup> with well-known principles for electroextraction<sup>18-24</sup>. This combination offers a highly selective sample preparation method using simple equipment and gains a high degree of enrichment within a short period of time.

The EME method extracts charged substances from a small sample volume through a thin membrane of organic solvent immobilized in the wall of a hollow fiber and into an acceptor solution inside the lumen of the hollow fiber. This extraction process is forced by an applied potential difference across the membrane. This combination of LLE with electrokinetic migration yields a rapid and selective sample preparation method for ionic substances. EME has shown to be compatible with a wide range of biological matrices, e.g. plasma, whole blood, urine, and breast milk, preparing clean extracts in a short period of time with simple, inexpensive equipment.

The technical setup for the equipment used in EME is based on earlier experiences with HF-LPME and is shown in **Figure 18.7**. The hollow fiber used is made of porous polypropylene, which is compatible with a broad range of organic solvents. To make the supported liquid membrane (SLM), the fiber is dipped in an organic solvent for 5 seconds to fill the pores in the walls, and the excess of organic solvent is gently removed with a medical wipe. The fiber, connected to the pipette tip, is guided through a punched hole in the sample compartment cap as illustrated in **Figure 18.7A**. The pipette tip works as a mechanical support for a 0.5 mm thick platinum wire placed inside the lumen of the hollow fiber. Another platinum wire is introduced directly into the donor phase through the sample compartment cap. When coupled to a power supply, these inert wires act as electrodes, thus creating an electrical field across the SLM. In this way, the equipment makes a closed electrical circuit, where the SLM functions as a resistor.

Figure 18.7

### EME Setup (A) and Principle (B), Demerol as the Model Substance

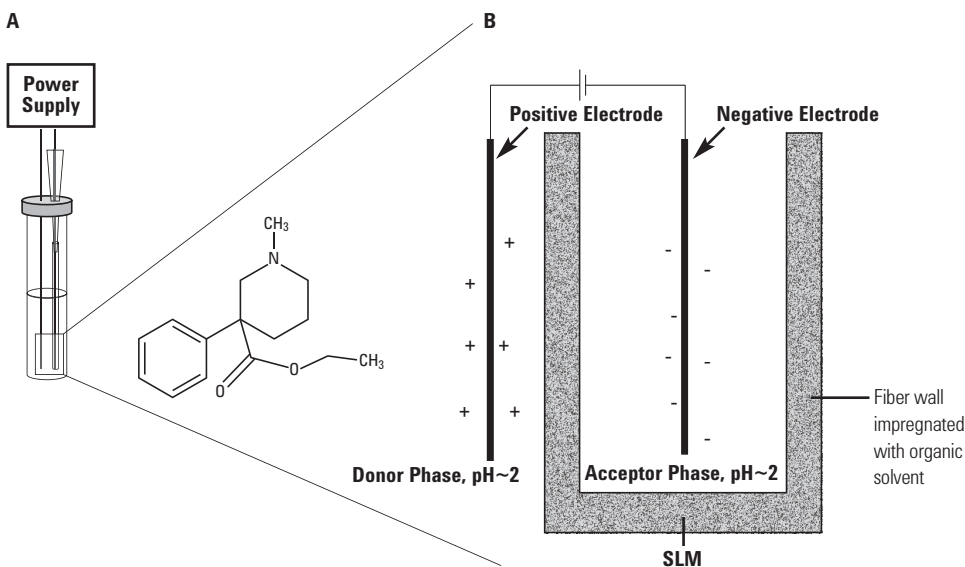

The volume of the sample varies between 150-500  $\mu\text{L}$ , depending on the sample compartment size. The sample is shaken on a platform shaker during the extraction to increase the physical movement of the analytes in the bulk donor phase, and to reduce the thickness of the stagnant layer at the interface between the donor phase and the SLM. The acceptor phase volume is set to 25  $\mu\text{L}$  and is introduced into the lumen of the hollow fiber by a microsyringe. When the predetermined extraction period is finished (usually only a few minutes), 20  $\mu\text{L}$  aliquot of the acceptor phase is collected by the microsyringe and transferred to a vial for analysis in a capillary electrophoresis (CE) instrument<sup>25-29</sup> or by HPLC<sup>30</sup>.

**Figure 18.7B** also depicts the mechanism of EME. The test substance Demerol is a synthetic opioid containing a nitrogen group that at low pH is protonated. The pH of both the donor and acceptor phases is 2. When an electric field is imposed across the HF, the positively charged analyte is attracted to the negative electrode in the EME setup and this strong attraction overcomes any partitioning into the SLM and the ion is transferred to the acceptor solution. Both acidic and basic compounds have been extracted with good efficiencies and reproducibility. Variables affecting the extraction efficiency and recovery include: imposed voltage, chemical nature of the membrane, type of organic solvent in the SLM (with or without additives like ion pair reagents), pH values of the donor and acceptor solutions, volume of donor solution, the type of sample matrix, degree of agitation, and extraction time.

## References

---

1. Greenway, G.M.; Kometa, N.; Macrae, R. *Food Chemistry* **1992**, *43*, 137-140.
2. Pingoud, A.; Urbanke, C.; Jeltsch, A.; Jeltsch, J. *Biochemical Methods: A Concise Guide for Students and Researchers*, Wiley-VCH, Weinheim, Germany, **2002**, ISBN-10: 3527302999 and ISBN-13: 978-3527302994.
3. Hassan Y. Aboul-Enein, (Ed.) *Separation Techniques in Clinical Chemistry*, CRC Press, New York, **2003**, ISBN-10: 0824740130 and ISBN-13: 978-0824740139.
4. Nandi, P.; Lunte, S.M. *Handbook of Sample Preparation*, Pawliszyn, J.; Lord, H.L. (Eds.) John Wiley & Sons, Hoboken, NJ, **2010**, 103-123, ISBN: 978-0-470-09934-6
5. Audunsson, G.A. *Anal. Chem.* **1986**, *58*, 2714-2723.
6. Jonsson, J.A.; Mathiasson, L. *Trends in Anal. Chem.* **1992**, *11* (3), 106-114.
7. Jonsson, J.A.; Mathiasson, L. *LCGC No. Amer.* **2003**, *21* (5), 424-438.
8. Tao, U.; Liu, J.-F.; Hu, X.-L.; Li, H.-C.; Wang, T.; Jiang, G.-B. *J. Chromatogr. A* **2009**, *1216*, 6259-6266.
9. Peng, J.-F.; Liu, J.-F.; Hu, X.-L.; Jiang, G.-B. *J. Chromatogr. A* **2007**, *1139*, 165-170.
10. Liu, J.-F.; Jiang, G.-B.; Cai, Y.Q.; Zhou, Q.-X.; Hu., J.-T. *Anal. Chem.* **2003**, *75*, 5870-5876.
11. Liu, J.-F.; Chi, Y.-G.; Jiang, G.-B.; Tai, C.; Peng, J.-F.; Hu., J.-T. *J. Chromatogr. A* **2004**, *1026* (1-2), 143-147.
12. Ho, T.S.; Halvorsen, T.G.; Pedersen-Bjergaard, S.; et al. *J. Chromatogr. A* **2002**, *963*, 3-17.
13. Zhao, L.; Lee, H.K.; Majors, R.E. *LCGC* **2010**, *28* (5), 580-591.
14. Lee, H.K. Paper presented at Separation Science Singapore 2009, Biopolis Science Park, Singapore, **August 26-28, 2009**.
15. Pedersen-Bjergaard, S.; Rasmussen, K.E. *J. Chromatogr. A* **2006**, *1109*, 183-190.
16. Pedersen-Bjergaard, S.; Rasmussen, K.E. *Anal. Chem.* **1999**, *71*, 2650-2656.
17. Pedersen-Bjergaard, S.; Rasmussen, K.E. *J. Chromatogr. A* **2008**, *1184*, 132-142.
18. Arrigan, D.W.M. *Anal. Lett.* **2008**, *41*, 3233-3252.
19. Berduque, A.; Arrigan, D.W.M. *Anal. Chem.* **2006**, *78*, 2717-2725.
20. Berduque, A.; O'Brien, J.; Alderman, J.; Arrigan, D.W.M. *Electrochem Commun* **2008**, *10*, 20-24.
21. Berduque, A.; Sherburn, A.; Ghita, M.; Dryfe, R.A.W.; Arrigan, D.W.M. *Anal. Chem.* **2005**, *77*, 7310-7318.
22. Vandervlis, E.; Mazereeuw, M.; Tjaden, U.R.; Irth, H.; Vandergreef, J. *J. Chromatogr. A* **1996**, *741*, 13-21.
23. Vandervlis, E.; Mazereeuw, M.; Tjaden, U.R.; Irth, H.; Vandergreef, J. *J. Chromatogr. A* **1995**, *712*, 227-234.
24. Vandervlis, E.; Mazereeuw, M.; Tjaden, U.R.; Irth, H.; Vandergreef, J. *J. Chromatogr. A* **1994**, *687*, 333-341.
25. Gjelstad, A.; Andersen, T.M.; Rasmussen, K.E.; Pedersen-Bjergaard, S. *J. Chromatogr. A* **2007**, *1157*, 38-45.
26. Gjelstad, A.; Andersen, T.M.; Rasmussen, K.E.; Pedersen-Bjergaard, S. *J. Chromatogr. A* **2006**, *1124*, 29-34.
27. Gjelstad, A.; Rasmussen, K.E.; Pedersen-Bjergaard, S. *Anal. Bioanal. Chem.* **2009**, *393*, 921-928.
28. Kjelsen, I.J.O.; Gjelstad, A.; Rasmussen, K.E.; Pedersen-Bjergaard, S. *J. Chromatogr. A* **2008**, *1180*, 1-9.
29. Middelthou-Bruer, T.M.; Gjelstad, A.; Rasmussen, K.E.; Pedersen-Bjergaard, S. *J. Sep. Sci.* **2008**, *31*, 753-759.
30. Gjelstad, A.; Andersen, T.M.; Rasmussen, K.E.; Pedersen-Bjergaard, S. *J. Chromatogr. A* **2008**, *1157*, 38-45.

# The Role of Scavengers in Sample Preparation

Scavengers are special types of solid phase particles that perform a similar role as SPE. However, instead of using molecular interactions, such as hydrophobicity or adsorption, scavengers use chemical reactions to remove undesired species. They are most often used by organic chemists in removing undesired reaction products or excess starting material from organic synthesis. Most scavengers operate by the use of covalent bonding. In most scavenging applications, the differentiation between product and starting material must be well defined. For example, while removal of nucleophiles – like an amine in the presence of an amide – is simple, the removal of primary amine in the presence of other amine functionalities may cause difficulties. Therefore, scavengers are made to be very selective. An example is shown in **Figure 19.1** where a polymer supported ketoester resin (PL-AAEM) can be used to selectively remove excess primary amine in the presence of more substituted amine products. The scavengers are therefore perfectly suited to reductive amination and some multicomponent reaction applications. If both primary and secondary amines are to be removed, then the less selective polymer supported isocyanate resin (PL-NCO) is available.

Figure 19.1

## Primary Amine Scavenger Chemical Reaction

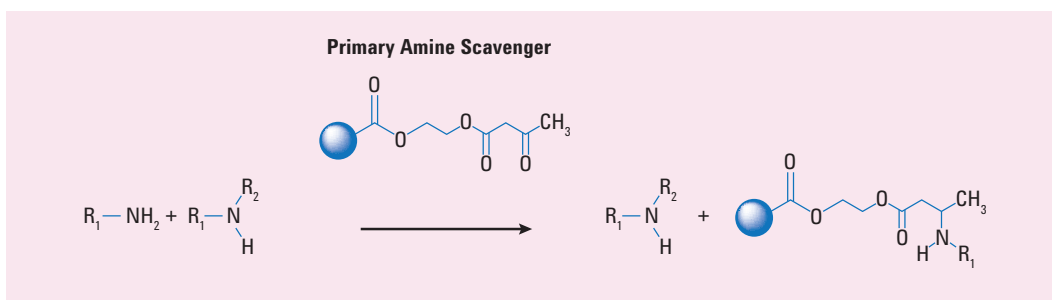

The removal of electrophilic reagents from solution using a scavenger resin with an amine group is very simple and effective. The polymer supported triamine resin (PL-DETA) can be used to remove acid chloride, sulfonyl chloride, isocyanates, and isothiocyanates according to the reaction scheme shown in **Figure 19.2**.

Figure 19.2

### Removal of Electrophilic Reagents Using PL-DETA Resin

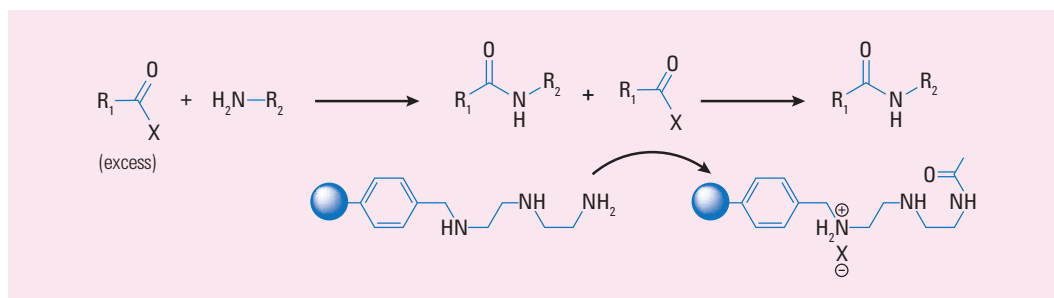

A particularly useful application of solid phase scavenger is removal of acidic mobile phase additives from HPLC fractions. The use of organic acids and HPLC mobile phase to aid solubility of polar molecules, especially biomolecules, is a well-known technique. Typically, 0.1% TFA in mixtures of water and acetonitrile are most commonly employed. If a compound is purified using preparative HPLC, the resulting solvent fractions will contain traces of TFA. If the species then undergo evaporation or lyophilization, the resulting organic species may be present as a TFA salt. Longterm stability of salts, particularly TFA salts, may be compromised. The use of a polymer supported hydrogen carbonate resin (PL- $HCO_3^-$  MP SPE, **Figure 19.3**) packed into a cartridge can be used for the pass-through removal of TFA and other organic and inorganic acids such as formic acid, acetic acid, and HCl.



Figure 19.3

## Removal of Formic Acid from Organic Solution Using Stratospheres

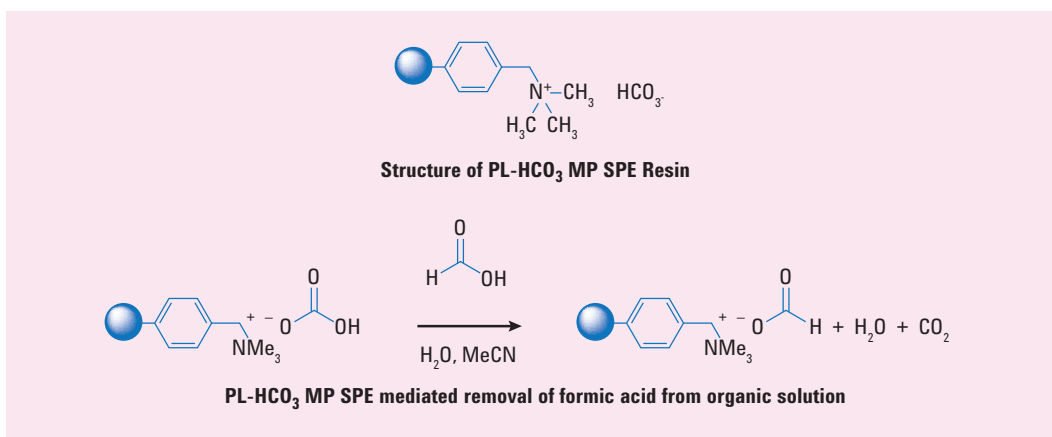

To demonstrate the effectiveness of the PL-HCO<sub>3</sub> MP SPE resin to remove formic acid from water-acetonitrile mixtures, a series of HPLC solutions bearing a mixture of water and acetonitrile containing 0.1% v/v formic acid were prepared and passed through a 200 mg PL-HCO<sub>3</sub> MP SPE device<sup>1</sup>. The capacity of the media for TFA removal was determined by measuring the pH of every 2 mL fraction; when the pH changed to approximately 2.5, the experiment was stopped and the volume of solvent was recorded. **Figure 19.4** shows that as the concentration of acetonitrile increases, the observed quenching capacity decreases only slightly. This is most likely due to a change in the residency time of the solvent mixture, a result of the reduction in viscosity of the sample. However, the capacity observed at 100% acetonitrile (30 mL) is still ample for most applications.

Figure 19.4

## Effect of Acetonitrile Content on the Volume of 0.1% Formic Acid Solution Scavenged Using a 200 mg/mL SPE Device

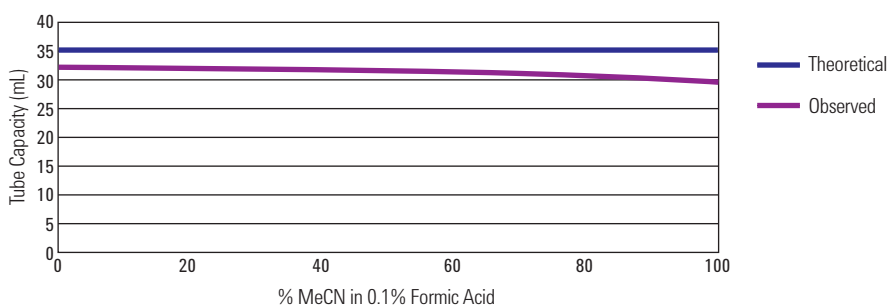

The experimental procedure for the removal of formic acid from organic solutions is simple. First, precondition the SPE cartridge with 1 mL of MeOH. Add formic acid containing solution to the SPE cartridge and allow the solution to pass through under gravity. Once all of the solution has passed through, wash the SPE cartridge with 1-2 mL of suitable solvent (in MeOH, H<sub>2</sub>O, etc.). Take the organic solution and remove the solvent in vacuo to yield the desired compound free of residual formic acid.

Polymer-based resin scavengers are available for a wide variety of organic compounds. Compared to SPE sorbents, scavengers are chemically reactive resins, so one should take extra precautions to store these materials in an inert, refrigerated atmosphere.

The removal of residual metal species, such as catalysts from organic reactions, is essential in providing clean, screenable compounds. A range of SPE devices have been designed to remove a broad range of metal reagents from organic reactions using a simple gravity flow method. Unwanted residues are retained by the sorbent in the SPE tube, allowing the desired compound(s) to pass through.

The StratoSpheres SPE range for metal removal is designed around a specially engineered macroporous particle, which has a high capacity and can be used in a broad range of solvents. The base polymer is functionalized with a range of ligands designed to bind metal reagents and catalysts. **Table 19.1** provides a listing of the SPE scavenger products and the metals that they will remove from solution.

**Table 19.1**

<b>Stratospheres Metal Removal Macroporous SPE Resins</b>	
<b>Product</b>	<b>Metals Removed</b>
PL-Guanidine MP SPE	Au, Bi, Cd, Hg, Pd, Pt, Re, Rh, Sn, Zn
PL-Thiol MP SPE	Ag, Au, Cu, Fe, Pd, Ru, Rh, Sn, Pb, Cu
PL-Thiourea MP SPW	Ag, Cd, Cu, Pt, Pd, Ru, Rh, Hg, Cu, Ni
PL-Urea MP SPE	Ag, Au, Hg, Ni, Pd, Pt, Re, Sc

To illustrate the use of a metal scavenger, fast and simple removal of Rhodium using Stratosphere SPE is shown. Rhodium-containing catalysts are used extensively in many aspects of synthetic chemistry – from small-scale applications such as the synthesis of small molecules for medicinal chemistry – to large-scale manufacturing. Despite the utility of rhodium reagents, the removal of the metal residues post reaction can cause difficulties. One of the most well-known Rhodium catalysts is Wilkinson's catalyst, a homogeneous catalyst used in the hydrogenation of alkenes. Another highly useful rhodium based reagent is rhodium acetate, which is used to initiate carbene formation from a diazo species.

PL-Thiol MP SPE and PL-Thiourea MP SPE are two metal scavenger products that can effectively remove rhodium residues from organic solutions in a single pass under gravity. **Figure 19.5** shows the structures of these two scavengers. The sorbents are made from highly cross-linked macroporous polymer that does not swell and can be used for a range of protic, non-protic, polar and apolar solvents. The conditions that were used for the cleanup are the same to the conditions used earlier for the removal of formic acid. Starting with a solution of 1000 ppm of rhodium concentration for both the Wilkinson's and the rhodium acetate catalysts, both scavengers decreased the rhodium concentration to less than 1/10 ppm<sup>2</sup>.

Figure 19.5

### Structures of Stratosphere SPE Phases Used for Rhodium Removal

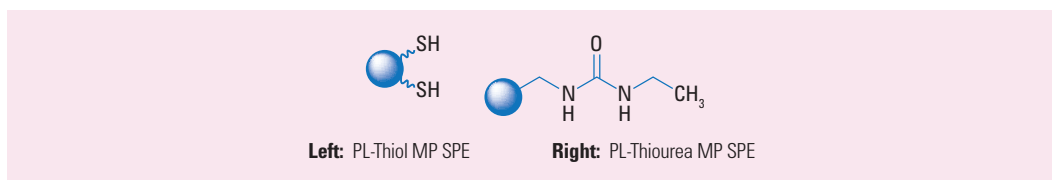

#### References

1. Boguszewski, P. *StratoSpheres SPE for Efficient, Flow Through Removal of Formic Acid*, Agilent Technologies Application Note #SI-01043, Santa Clara, CA, **2007**.
2. Boguszewski, P. *Fast and Simple Removal of Rhodium Using StratoSpheres SPE*, Agilent Technologies Application Note #SI-01042, Santa Clara, CA, **2007**.

# Derivatization for HPLC and GC Analysis

Derivatization involves a chemical reaction between an analyte and a reagent to change the chemical and physical properties of the analyte. The five main uses of derivatization in HPLC and GC are to:

- Improve detectability
- Change the molecular structure or polarity of analyte for better chromatography
- Increase volatility
- Change the matrix for better separation
- Stabilize an analyte

Ideally, a derivatization reaction should be rapid, quantitative, and produce minimal by-products. Excess reagent should not interfere with the analysis or should be easily removed from the reaction matrix. There are many good reference books available for derivatization procedures for chromatographic separations<sup>1-5</sup>.

With the increased popularity of MS techniques (e.g. LC/MS, LC-MS/MS, GC/MS and GC-MS/MS), many laboratories prefer an instrumental approach to high sensitivity and selected detection rather than contend with a relatively time-consuming, labor-intensive compound derivatization approach. Derivatization is often a last resort when developing a method since it adds to the time of analysis, adds a degree of complexity, can be a source of error, and it may add undesired components (e.g. reaction by-products of analytes or matrices) into the chromatography. While derivatization procedures can be automated, the analyst must ensure that the derivatization step is quantitative (if necessary) and that there are no additional impurities introduced in the analysis. Although, the derivatization method may have drawbacks, it is still a powerful technique for the separation and detection of trace amounts of substances in a complex matrix. In fact, in some cases, MS detection derivatization is used to enhance positive (or negative) ionization.

In this chapter, derivatization in HPLC will be covered, followed by derivatization by GC.

# HPLC Derivatization for Detectability

Unlike GC, where derivatization is generally used to improve the volatility or change the polarity of an analyte, derivatization in HPLC (with the exception of chiral analysis) is predominately used for the enhancement of analyte detectability, particularly for analytes that possess no chromophore. HPLC offers a wide range of separation mechanisms (i.e., normal and reversed-phase, chiral, and ion chromatography), types of stationary phases, and mobile phase modifiers which can be added directly to the mobile phase to overcome interactions with the stationary phase – such as chemisorption, adsorption, and tailing.

The first consideration in choosing an HPLC derivatization method for detection enhancement is to decide if a suitable active functional group (or groups) is available for chemical reaction. At the same time, one must decide which type of detection principle is best suited for these derivatized compounds. Of course, that detector must be available in the laboratory. Most popular detectors for derivatized compounds include UV-visible, fluorescence, and electrochemical. In addition, the choice of whether to use pre- or post-column derivatization is required (see later in this chapter). Sample components with active functional groups such as alcohols, phenolic, amine, carboxyl, olefin, and others are candidates for derivatization. Several classes of compounds can be derivatized (**Table 20.1**) some of these include acids, alkaloids, amines, antibiotics, barbiturates, and related compounds, hydroxy compounds, and steroids.

The two most common types of derivatization – the addition of chromophore or fluorescent functional group for UV and fluorescent detection, respectively – allow detection of an analyte that cannot be detected in its normal form or to increase its sensitivity. General considerations in choosing a derivatizing reagent are:

- The derivatizing agent must be stable.
- The derivatizing agent and by-products formed during derivatization should not be detectable or must be separated from the analyte.
- The analyte must be reactive with derivatizing reagent under convenient conditions.
- Reagents should be non-toxic if possible.
- The procedure should be adaptable to automation.

Many organic reactions could be used for analyte derivatization. However, for routine use, the best approach is to choose the proper derivatizing reagent using pre-prepared derivatization kits and step-by-step instructions from various reputable suppliers.

Table 20.1

**Functional Group and Derivatization Reagents for UV and Fluorescence Detection\***

Functional Group	UV Derivatives	Fluorescent Derivatives
Carboxylic Acids	PNBDI	BrMaC
Fatty Acids	DNBDI	BrMmC
Phosphonic Acids	PBPB	
Alcohols	DNBC Dabsyl-Cl NIC-1	
Aldehydes	PNBA	Dansyl Hydrazine
Ketones	DNBA	
Amines, 1°		Fluorescamine OPA
Amines, 1° & 2°	DNBC SNPA SDNPA Dabsyl-Cl NIC-1	NBD-Cl NBD-F Dansyl-Cl
Amino Acids (Peptides)	SBOA SDOBA Dabsyl-Cl	Fluorescamine OPA NBD-Cl NBD-F Dansyl-Cl
Isocyanates	PNBPA DNBPA	
Phenols	DNBC Dabsyl-Cl NIC-1	NBD-Cl NBD-F Dansyl-Cl
Thiols	Dabsyl-Cl	NBD-Cl NBD-F OPA

Chromotags abbreviations		Fluorotag Abbreviations	
Dabsyl-Cl	4-Dimethylaminazobenzene-4-sulphonyl	NBD-Cl	7-Chloro-4-nitrobenzo-2-oxa-1,3-diazole
DNBA	3,5-Dinitrobenzyloxyamine Hydrochloride	NBD-F	7-Fluoro-4-nitrobenzo-2-oxa-1,3-diazole
NIC-1	1-Naphthylisocyanate	Fluorescamine	4-Phenylsprio(furan-2(3H),1'-phthalan-3,3-dione
PBPB	p-bromophenacyl Bromide	OPA	o-Phthaldehyde
PNBA	p-Nitrobenzyloxyamine Hydrochloride	Dansyl-Cl	5-Dimethylaminonaphthalene-1-sulfonyl Chloride
PNBDI	p-Nitrobenzyl-N,N'-diisopropylisourea	BrMmC	4-Bromomethyl-7-methoxycoumarin
DNBDI	3,5-Dinitrobenzyl-N,N'-diisopropylisourea	BrMaC	4-Bromomethyl-7-acetoxycoumarin
PNBPA	P-Nitrobenzyl-N-n-propylamine Hydrochloride		
DNBPA	3,5-Dinitrobenzyl-N-n-propylamine Hydrochloride		
SNPA	N-Succinimidyl-p-nitrophenylacetate		
SDNPA	N-Succinimidyl-3,5-dinitrophenylacetate		
DNBC	3,5-Dinitrobenzyl Chloride		

\* Courtesy of Regis Technologies

## UV-Detection

Typically, a reagent used for UV-visible detection will have two important functional groups. One functional group controls the reaction of the reagent with the analyte of interest and the second is used for UV detection. The chromophore should have a large molar absorptivity with an adsorption band that can be used to maximize detection and minimize background noise. **Table 20.2** lists some of the common chromophores used for UV detection along with their maximum absorption wavelength and their molar absorption coefficient at 254 nm. Reagents having a molar absorption coefficient of 10,000 or more allow detection in the low ng range. **Table 20.1** listed some commercially available derivatization reagents for UV detection. The analyte functional groups that they will derivatize are also shown in the table.

Table 20.2

Chromophores of Interest for Enhanced UV Detection		
Chromophore	Wavelength of Maximum Absorption	Molar Absorption Coefficient at 254 nm
Benzyl	254	200
4-Nitrobenzyl	265	620
3,5-Dinitrobenzyl	-----	> 10,000
Benzoate	230	low
4-Chlorobenzoate	236	6,300
4-Nitrobenzoate	254	> 10,000
2,4-Dinitrophenyl	-----	> 10,000
Toluoyl	236	5,400
Anisyl	262	16,000
Phenacyl	250	10,000
4-Bromophenacyl	260	18,000
2-Naphthacyl	248	12,000

Note that many of the common reagents for introducing nitrobenzyl chromophores (**Table 20.2**) into a molecule for UV-visible detection are also suitable for use with electrochemical detection. In addition, OPA derivatives of amines and amino acids can be determined at very low levels with electrochemical detection. For further information on the use of derivatization for electrochemical detection in HPLC, consult reference 4.

## Fluorescence Detection

In addition to the considerations above for derivatizing reagents, fluorescent derivatization reagents require a fluorophore that possesses intense absorption bands and a large quantum yield. Due to the special properties required for strong fluorescence response, there are fewer fluorescent derivatization reagents than there are for UV-Detection (**Table 20.1**). See **Figure 20.1** for an application of fluorescence derivatization.

## Precolumn Derivatization

There are several advantages for precolumn derivatization compared to post-column derivatization. Precolumn derivatization has fewer equipment and chemicals restrictions since the analysts can perform the derivatization, then transfer the sample to the appropriate vial for analysis. Precolumn derivatization can be performed manually or automated. Several manufacturers of analytical instrumentation or robotics offer automated precolumn derivatization. There are no time constraints on the kinetics of the derivatization reaction, provided all the reagents, analytes, and derivatized species are stable. Finally, sample preparation procedures described in this book can be used to remove undesired by-products, sample interferences, and if necessary, change the sample solvent to be compatible with the HPLC mobile phase and the GC stationary phase.

Some drawbacks of precolumn derivatization are the introduction of contaminants and loss of analyte through: adsorption, undesired side reactions, possible sample degradation, sample transfer, and incomplete reactions. Also, additional time is required for derivatization and the added complexity can result in poorer method precision.



## Post-Column Derivatization

Post-column derivatization is commonly accomplished using a reaction detector where the analyte is derivatized after the separation but prior to detection. Reaction detector design takes into account the dispersion of the sample within the reaction system. The three most common approaches to reactor design are: capillary, packed bed, and air segmented for fast (<1 min), slow (1-5 min) and slower (5-20 min) reactions rates, respectively. The main advantages of post-column derivatization are: minimal artifact formation; reaction completion is not essential as long as it is reproducible; and the chromatography of the analyte is unaffected.

The drawbacks to post-column derivatization are band broadening for all but very fast reactions, and the added complexity for both method development and routine applications. Important considerations are the kinetic requirements (a maximum of 30 minutes for reaction completion) and possible incompatibility between the mobile phase and derivatizing reagents. Ensuring reagent and mobile phase compatibility also can complicate HPLC method development, because the requirements of the derivatization must be considered along with those of the separation. The best mobile phase for separation can be incompatible for the derivatization reaction.

To illustrate an example of post-column derivatization, the analysis of the pesticides carbaryl and carbofuran in drinking water is presented<sup>6</sup>. These N-methyl carbamates (structures shown on left side of **Figure 20A**) are classified as broad-spectrum insecticides and are mostly used on rice and corn crops. Excess pesticide can contaminate groundwater, surface water and drinking water. Low levels of these pesticides in drinking water have been found to create health problems in the neurological and reproductive systems.

In this application, automated SPE was first used to isolate the trace amounts of these pesticides in water<sup>6</sup>. After conditioning the SPE cartridge, a 1 L sample of water was passed through the cartridge concentrating the organic material present. Dichloromethane was found to be the optimum elution solvent for the SPE cartridge. For the chromatography, reversed-phase HPLC and post-column derivatization were used. Prior to the derivatization, carbaryl and carbofuran were first hydrolyzed under basic conditions with an initial post column reaction at high temperature into methyl amine. The methyl amine, in turn, was reacted with o-phthalaldehyde (OPA) and 2-mercaptoethanol (RSH) to yield isoindoles that are highly fluorescent (right side of **Figure 20.1A**). The initial compounds had no inherent fluorescence. **Figure 20.1B** (see next page) shows the strong fluorescence signal resulting from the carbamates spiked in tap water. Note that to prevent residual chlorine in the water from affecting the trace concentrations of the pesticides, a small amount of sodium thiosulfate was added to the sample. Post-column reaction method showed excellent linearity, very good reproducibility (% RSD less than 2), good recovery (80-110%), and limits of detection into the parts per trillion range.

Figure 20

### Structures of Carbamates and Post-Column Derivatization Reaction

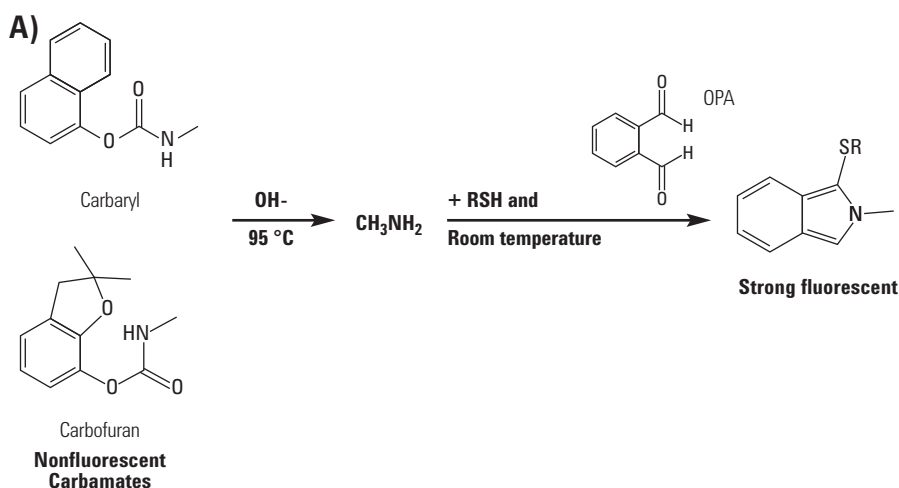
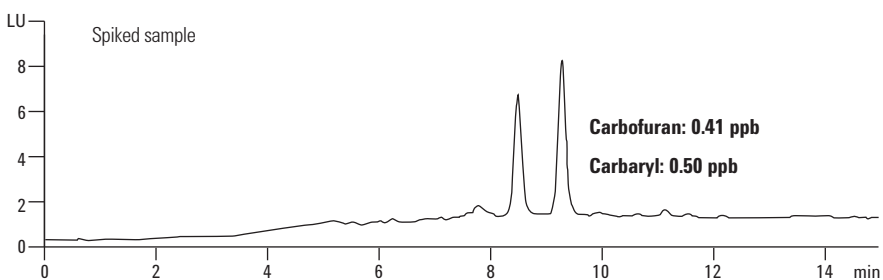
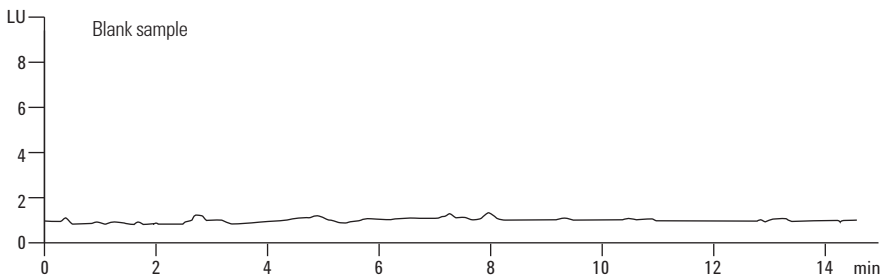

Figure 20 (Continued)

## B) Post-Column Fluorescence Chromatogram of Tap Water Spiked with ppb Concentrations of Carbamate Pesticides



### Experimental

**Instrument:** Agilent 1100 or 1200 with fluorescence detector (FLD): A multidraw upgrade kit can be installed when 400  $\mu$ L injections are needed.

**Column:** Agilent TC-C18(2) 4.6 x 150 mm, 5  $\mu$ m

**Mobile Phase:** A: Water, B: Methanol  
0 min 42% B, 5 min 55% B,  
12 min 60% B  
13 min 42% B, stop time 15 min,  
post-run 2 min

**Flow Rate:** 1.0 mL/min

**Temperature:** 30  $^{\circ}$ C

**Detector:** Fluorescence: Ex 339 nm; Em 445 nm

**Injection Volume:** 10  $\mu$ L

### Post-Column Reaction Conditions

**Flow Rate of Reagents:** 0.1 mL/min

**Reactor Temperature:** 95  $^{\circ}$ C

**Derivatization Temperature:** Room Temperature

**SPE Cartridges Agilent Technologies, Inc.** SampliQ C18, 6 mL/500 mg

## Other Uses for Derivatization

Although mainly associated with GC, derivatization in HPLC for reasons of volatility may be important for the evaporative light scattering detector or the corona discharge detector, which work best for volatile analytes. Derivatization of polar groups, such as amines, may cut down on tailing using silica-based reversed-phase columns because of silanol- or ionic-interactions.

Unlike derivatization of non-chiral separations, the major use of chiral derivatization is to enhance the separation, and not to improve detection. However, the oldest method of chiral separation is derivatization. Thus, there is a wealth of information available, and several functional groups have been derivatized. Chiral derivatization has been applied to both reversed and normal phase liquid chromatography. The key to chiral analysis is the ability to react an optically active target molecule with an optically active reagent.

There are several advantages and limitations to chiral analysis via derivatization:

### Advantages

- The technique has been studied extensively and there is a wealth of information making the technique easy and accessible.
- The methods use standard HPLC supports and mobile phases.
- If detection is a problem, derivatization for detection and separation can be accomplished in one step.

### Limitations

- For enantiomeric compounds, the compounds of interest must be isolated and then derivatized, making automation difficult.
- The purity of the derivatizing reagent is critical, since the presence of enantiomeric contamination can yield false measurement.
- For enantiomers that have different rates of reaction and/or equilibrium, constants results may not provide the true enantiomeric ratios.
- The possible racemization of the product during sample processing.

In addition to the derivatization of chiral compounds, the use of achiral reagents can increase the selectivity of the chiral stationary phase (CSP) toward a chiral analyte. Some compounds do not have distinct enough binding sites to obtain adequate resolution on a CSP, and derivatization with achiral reagents allows their separation.

# Derivatization in Gas Chromatography

In GC, the main purpose of derivatization is to increase analyte volatility. Molecules, especially compounds that are of biological and environmental interest that are of high molecular weight and/or contain polar functional groups, are thermally unstable at the temperatures required for their separation by GC are candidates to be derivatized for GC. The main type of derivatization involves the reaction of protonic functionalities into thermally stable, more volatile, non-polar functional groups. Besides improving thermal stability, derivatization improves peak shape by minimizing wall and other interactions that could result in tailing and/or irreversible adsorption. There are a wide variety of derivatizing reagents for GC and some of the more popular are listed in **Table 20.3**. There are many publications summarizing the various derivatization methods for GC-amenable compounds<sup>1,3,5</sup>.

**Table 20.3**  
**Typical Derivatizing Reagents Used in GC**

Class of Reagent	Typical Reagent Compounds	Compounds Derivatized	Comments
Trialkylsilane	TMCS, HMDS, MSTFA, MSTFA, BSTFA	Alcohols, phenols, carboxylic acids, thiols, amines, amides	Most widely used, use anhydrous conditions, rate of reaction based on steric factors, use of catalysts, choice of solvent and temperature; few artifacts except multiple products for sugars; halogenated silanes available for ECD detection.
Haloalkylacryl	Perfluorocarbonacyl (e.g. trifluoroacetyl-, pentafluoropropionyl-, heptafluorobutryl- )	Amines, phenols	Prepared from acid anhydrides or acid chlorides usually in presence of base (e.g. pyridine, triethylamine); introduction of electron-capturing groups for ECD detection.
Haloalkylacryl	Alcohols	Carboxylic acids	Reaction performed with excess of alcohol with acid catalyst (e.g. HCl, acetyl chloride, boron trifluoride); removing water by-products helps derivatization process; methyl esters most popular.
Alkylation	Alkyl halides, diazoalkanes, acetals, N,N'-dimethylformamide dialkyl acetals	Active hydrogen-containing compounds (e.g. -COOH, -SO <sub>2</sub> OH, -OH, -SH, -NH <sub>2</sub> , =NH )	A catalyst must be present to ensure complete reaction; typical catalysts include silver oxide, barium oxide, sodium hydride.
Pentafluoro (PF) Phenyl	PF-benzoic anhydride, PF-benzyl bromide, PF-benzoyl chloride, and others	Alcohols, amines, phenols, carboxylic acids, ketones	Useful for broad spectrum of organic compounds; stable derivatives, good volatility for derivatives, can be detected by ECD.
Oximes	Hydroxylamine or derivatives (Me, Et, or benzyl)	Ketones, aldehydes	Mainly for protection of keto groups when other derivatives are being formed

**Codes:**

TMCMS: Trimethylchlorosilane

HMDS: Hexamethyldisilazane

MSTFA: N-methyl-N-(trimethylsilyl)acetamide

MTBSTFA: N-tert-Butyldimethylsilyl-N-methyltrifluoroacetamide

For GC, the silylation reagents are the most popular and universal. They're very reactive, can derivatize most functional groups, and with most compounds do not form by-products or artifacts. The trimethylsilyl ether derivatives themselves are stable under anhydrous conditions. New silyl homolog or analog agents have been developed that have improved hydrolytic stability or better detectability. A typical reaction to perform a trimethylsilyl derivatization for organic acids is shown below.



Silylation reactions are generally performed in glass vials, often at elevated temperatures. Take note of the possible leakage with PTFE-line screw caps that may occur at elevated temperatures. Sometimes a basic catalyst (e.g. pyridine, diethylamine) is used to remove the HCl by-product. Occasionally, mixtures of trimethylsilane reagents are used and can be more effective than any one alone.

Improved detection is another important goal for derivatization in GC. Silylating reagents containing electron capture groups such as chloro, bromo, or iodo (electron capture detector) and cyano groups (thermionic detector) have been developed for improved detectability. Virtually all GC derivatization reactions are performed by precolumn derivatization reactions.

Recently, with the increasing importance of tandem LC-MS/MS techniques, gas chromatographers have been switching some of their analysis to LC to avoid going through derivatization reactions. The sensitivity and selectivity of these tandem MS techniques rival the selective and sensitive GC detectors (see Chapter 17 for more details).

## References

---

1. Poole, C.F.; Poole, S.K. *Chromatography Today*, Elsevier, Amsterdam, **1993**.
2. Lunn, G.; Hellwig, L.C. *Handbook of Derivatization Reactions for HPLC*, Wiley-Interscience, Hoboken, NJ, **1998**, ISBN-10: 0471238880 and ISBN-13: 978-0471238881.
3. Blau, K.; Halket, J. (Eds.) *Handbook of Derivatives for Chromatography*, 2nd Ed., John Wiley and Sons, Chichester, U.K., **1993**.
4. Lingeman, H. *Detection-Oriented Derivatization Techniques in Liquid Chromatography*, CRC Press, New York, **1990**, ISBN-10: 0824782879 and ISBN-13: 978-0824782870.
5. Drozd, J. *Chemical Derivatization in Gas Chromatography*, Elsevier Science, **1986**, ISBN-10: 0444553223 and ISBN-13: 978-0444553225.
6. Fu, R. Agilent Technologies Publication #5989-9802EN, Shanghai, China, **2008**.

# *Just Enough* Sample Preparation: A Proven Trend in Sample Analysis

Sample preparation (and to a lesser extent data analysis) has often been considered to be the rate determining step and error-prone part of an analytical method. If selectivity can be achieved in other portions of the analytical cycle to meet the needs of the analyst, then the burden placed on sample preparation is decreased. The concept of *Just Enough* sample preparation is presented in this chapter and is based on the LCGC No. America<sup>1</sup> article that introduced the concept. Just Enough sample preparation relies heavily on recent advances in the tandem mass spectrometry detection that provides enhanced sensitivity and selectivity, unavailable in the past. Even so, more sophisticated sample prep protocols may still be required, especially if ion suppression/enhancement results from co-eluting interferences.

The topic on how selectivity can be incorporated throughout the sample analysis cycle has been discussed previously<sup>2</sup>. **Figure 21.1** illustrates the workflow in a typical sample analysis. In most analytical processes, the chemist is looking for one or perhaps a few analytes of interest, often in a very complex matrix. Having an analytical method showing sufficient selectivity to analyze those few compounds of interest with the precision and accuracy required at the concentration level encountered is the desired outcome of method development. The selectivity can be achieved anywhere within the analytical cycle (**Figure 21.1**) during sampling, during sample preparation, sample introduction, the chromatographic separation, at the detector, or even during data analysis. As long as the analytes of interest can be determined with good sensitivity, the presence of compounds from the sample matrix can be tolerated as long as those interferences do not cause harm (short-term or long-term) to the analytical instrument or the column, or if determined to be harmful, they can easily be removed. An example of the latter approach could be backflushing after each analysis to remove high-molecular-weight contaminants trapped at the head of a GC column. Examples of how selectivity can be achieved at each step of the analytical cycle for gas chromatography were shown in reference <sup>2</sup>.

Figure 21.1

## Steps in Analytical Cycle<sup>1</sup>

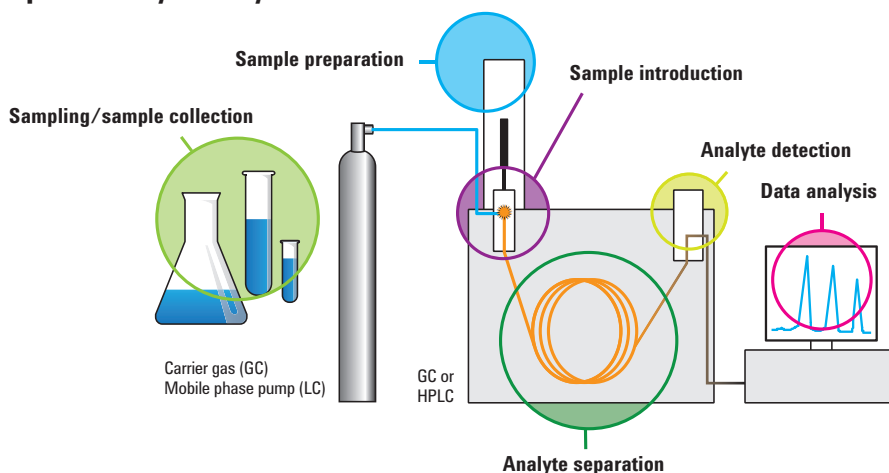

Having less selectivity in one portion of the analytical cycle can be made up for by having greater selectivity in another portion of the analytical cycle. For example, if the analyst only has a fixed wavelength UV detector in his/her HPLC instrument or a thermal conductivity or flame ionization detector for the GC, there may not be sufficient detector selectivity to provide the necessary overall method selectivity to measure an analyte of interest without interference from undesired sample components. Therefore, additional sample preparation or finding a separation column that provides more selectivity during the separation may be required to make up for the limitations in the detector. In these cases, the analyst may spend a great deal of time and energy performing one or more sample preparation steps or optimizing the selectivity of the column/mobile phase system (HPLC) to rid of potential interferences. On the other hand, if one has a very sensitive and selective detector, then perhaps spending a great deal of time optimizing the sample preparation and/or the analytical separation is unwarranted.



Since achieving selectivity for the separation column is not an easy task to predict, sample preparation often gets the brunt of the job to remove interferences from the sample of interest. It is sometimes unfortunate to burden the analyst with this job, but there are time-proven sample prep techniques available. However, with the advent and widespread use of tandem mass spectrometry for both HPLC and GC with its high degree of selectivity and sensitivity, sample preparation as well as the chromatographic separation can sometimes be simplified as long as any interferences carried over from the sample matrix do not interfere with the separation or detection process. We term this simplified sample preparation process as *Just Enough* sample preparation.

This Just Enough sample preparation process doesn't always provide the cleanest extract from the sample as more rigorous approaches such as multimodal solid phase extraction (SPE) or liquid-liquid back extraction might achieve, but as long as the extractables do not harm separation or detection (and, of course, the column or instrument), that's okay. In reality, the sample preparation time can be greatly reduced as long as the final outcome meets the needs of the analyst. Although the mass spectrometer still represents a much higher priced detector than a UV or FID, many laboratories are finding them to be a cost effective way to enhance and speed up their analyses, thereby improving overall productivity and lowering costs. Of course, less expensive selective detectors such as fluorescence in HPLC and electron capture in GC still allow the practice of Just Enough sample preparation provided the analytes do not need derivatization.

The concept of Just Enough sample preparation does not imply one is cutting corners or that more sophisticated protocols are not required. It really represents a continuum of sample preparation procedures as depicted in **Figure 21.2**. This figure represents just a few of the many sample preparation methods that are in widespread use. Starting at the top of the figure with filtration, centrifugation, and "dilute and shoot" and moving down, the sample preparation protocols become more selective and more complex sometimes requiring a greater deal of effort and multiple steps to achieve Just Enough cleanup to meet the analytical needs. Minimizing the number of sample handling steps in any analytical technique is desirable since the more times the sample is transferred, the greater the chance of analyte loss (or modification), thereby resulting in poorer analytical precision and accuracy. If one or two steps meet the needs of the method, that may be sufficient, but in some cases, additional sample preparation steps may be needed to rid of interferences. The need to eliminate or minimize interferences is no greater than that required for LC/MS and LC-MS/MS (see **Figure 21.2**).

Figure 21.2

## Just Enough Sample Preparation Represents a Continuum of Methodologies

### Methodology

- Filtration
- Centrifugation
- Dilute and shoot
- Sonication
- Lyophilization
- Protein precipitation
- Distillation
- Dialysis/ultrafiltration
- Liquid-solid extraction/pressurized fluid extraction
- Soxhlet extraction
- Solid phase microextraction
- Supported liquid extraction
- Liquid-liquid extraction
- Solid phase extraction
- QuEChERS
- Turbulent flow chromatography
- Derivatization
- Column switching/heart cutting
- Immunoaffinity sorbents
- Molecularly imprinted polymers

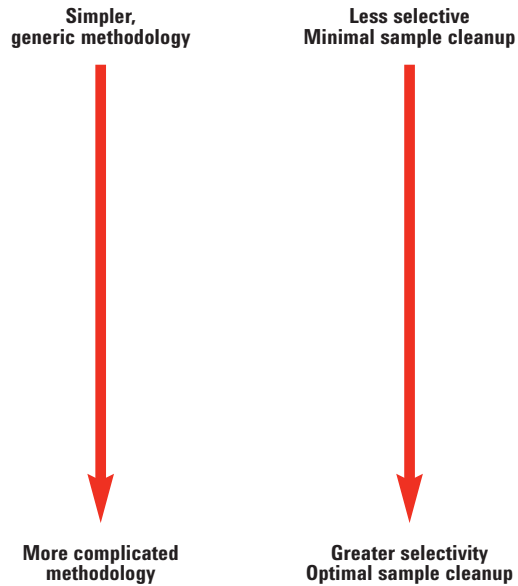

**Figure 21.3** shows a pictorial representation of the Just Enough sample prep concept that actually applies to the entire analytical cycle, but is emphasized for the sample preparation portion. It is here that many workers are faced with achieving the bulk of their selectivity enhancement. Ideally, in an analytical method, one always wants to achieve the best result with the least amount of effort and investment. On the other hand, the actual data requirement may not need the optimum result, but an acceptable result. For example, in screening hundreds of urine samples for the presence of drugs of abuse, most samples are negative. Thus, a qualitative analytical method may be sufficient to rule out the presence of an illicit drug. However, if an illegal drug is spotted during the screening test, then a more careful and perhaps a more sophisticated look at a positive sample is required for quantitative analysis.

Figure 21.3

## Striking the Right Balance in Sample Preparation

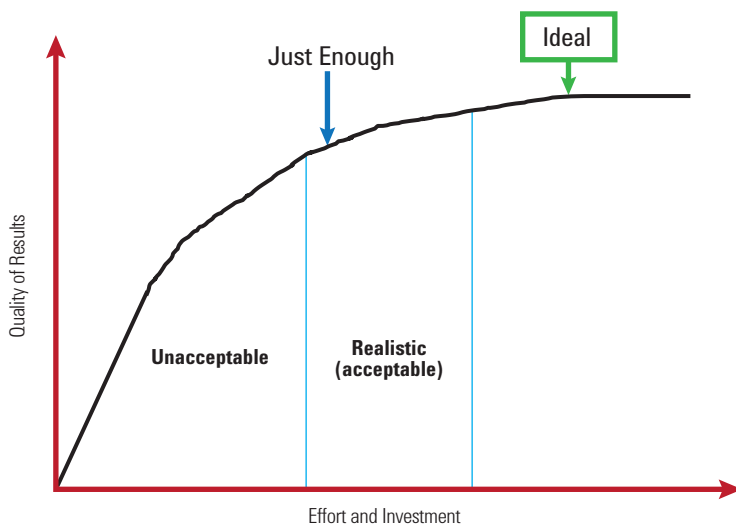

There are many other factors that may influence the choice of the sample preparation technique(s) used to provide Just Enough cleanup. The skill and knowledge of the analyst is important. The availability of instrumentation, chemicals, consumables, and other equipment; the time available to develop the method and to perform the tasks at hand; the complexity and nature of the matrix; the analyte concentration level and stability; the required sample size; the cost per sample (budget); and the safety of the sample preparation technique are just a few of the many considerations that must be taken into account. It is the balance of all of these and other considerations that come into play.

## Examples of Just Enough Sample Preparation

Many sample preparation methodologies have already been discussed throughout this book. Figure 21.2 provides a number of sample preparation protocols that could qualify as Just Enough procedures. As mentioned earlier, the fewer sample preparation steps in analytical method, the less chance of errors, better analyte recovery, and less time spent handling samples. However, as one proceeds down **Figure 21.2**, Just Enough may require more sophisticated sample preparation processes.

Let's look at a few examples of sample preparation procedures that may qualify as Just Enough and see if they provide acceptable results. In recent years, for the determination of targeted drugs and their metabolites in biological fluids such as plasma, many pharmaceutical companies have switched their sample preparation to protein precipitation (see Chapter 16) and reversed-phase HPLC analysis, but using a more selective, sensitive LC-triple quadrupole MS/MS detector using Multiple Reaction Monitoring (MRM) at defined transitions. The first example shows the direct analysis of Fluticasone Propionate (FP) in human plasma using an LC-triple quadrupole mass spectrometer system<sup>3</sup>. The FP is a synthetic steroid of the glucocorticoid family of drugs for treating allergic conditions. When used as a nasal inhaler or spray, medication goes directly to the epithelial lining of the nose, and very little is absorbed into the rest of the body. Due to its low systemic levels, a high sensitivity LC/MS assay is required to determine its concentration in human plasma. **Figure 21.4** shows the LC/MS results from a plasma protein precipitation (see Chapter 16, *Protein Precipitation*) followed by dilute and shoot using the MRM transition shown in the figure caption. In this case, the dilute and shoot method has more than adequate sensitivity at the lowest calibration level of 5 pg/mL. Thus, protein precipitation followed by dilute and shoot sample preparation has an assay performance well within accepted regulatory guidelines and was Just Enough to meet the analytical needs.

Figure 21.4

### Measurement of Fluticasone Propionate in Plasma Using Dilute and Shoot Sample Preparation<sup>3</sup>

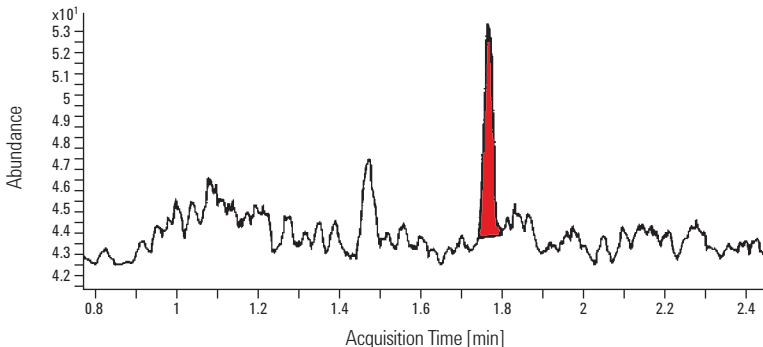

**Instrument:** Agilent Model 6490 LC-Triple Quadrupole LC/MS System (MRM transition 501.2 → 293.1) for 2.5 femtograms injected on-column; 1 femtogram limit of detection; standard curve was linear over the range of 5-50 mg/mL

**Sample preparation:** plasma sample was precipitated with acetonitrile and then diluted 4-fold with water

A second example of Just Enough sample preparation was shown in Chapter 16, which also showed a protein precipitation, but considered an area where ion suppression comes into play. The figures will not be repeated here and the reader is referred back to Chapter 16, *Removal of Lipophilic Material*. The presence of (phospho)lipids in plasma can cause ion suppression if analytes of interest co-elute in the portion of a chromatogram where these phospholipids appear. Phospholipid MS-MS selectivity can be achieved by considering the  $m/e\ 184 \rightarrow m/e\ 184$  transition indicative of phospholipid and lysophosphatidylcholine elution. **Figure 16.6.1** showed a typical infusion experiment result that is obtained from protein-precipitated plasma, followed by Captiva filtration (Agilent Technologies, Santa Clara, CA). If the drug and/or its metabolites were to co-elute with these compounds, ion suppression may occur and the analytical results jeopardized. Thus, in this case, the simple protein precipitation sample preparation procedure may not be enough to provide reliable data.

By performing the more complex SPE (**Figure 16.6.2**) or liquid-liquid extraction (**Figure 16.6.3**), the extract is now cleaner and many of the phosphorous-containing lipids are greatly reduced. To get the best overall performance, an even more sophisticated phospholipid reduction may be achieved with a selective SPE phase that removes the last traces of phosphorylated compounds (**Figure 16.6.4**). Luckily, a product called Captiva ND<sup>Lipids</sup>, which is a combined membrane filtration/phospholipid removal 96-well plate, performs both operations at once and thus is a simple Just Enough solution to this problem.

QuEChERS (covered in Chapter 8) is a sample preparation technique that was originally developed for the extraction of pesticides from fruits and vegetables<sup>4</sup>. It is a relatively simple sample preparation procedure involving two steps: 1) a salting out partitioning extraction involving water and acetonitrile with high concentrations of salts such as sodium chloride, magnesium sulfate, and buffering agents, and 2) a dispersive-SPE step where an aliquot from step 1 is treated with various sorbents to remove matrix compounds that could interfere with subsequent LC/MS, LC-MS/MS, GC/MS or GC-MS/MS analysis. The technique has proven to be widely applicable at trace levels for hundreds of pesticides in a variety of matrices. Standard protocols are available that make it a generic sample preparation procedure.

Recently, QuEChERS extraction has expanded well beyond the pesticide laboratory and has been used for many matrices ranging from antibiotics in meat and poultry, veterinary drugs in animal feed, and environmental contaminants in soil. In this third example of Just Enough Sample Preparation, using the protocol in **Figure 21.5**, QuEChERS was used for the extraction of polycyclic aromatic hydrocarbons (PAHs) in fish. The PAHs are a large group of organic compounds included in the European Union and the United States Environmental Protection Agency priority pollutant list because of their mutagenic and carcinogenic properties. In the marine environment, PAHs are bioavailable to marine species via the food chain, as water borne compounds, and contaminated sediments. This application shows that tandem MS detection techniques are not necessarily required for Just Enough sample preparation. Most of the PAHs are highly fluorescent and thus, as shown in **Figure 21.6**, reversed-phase HPLC was combined with fluorescence detection to determine 16 of these compounds at a spiking level of less than 10 ng/g level<sup>5</sup>. QuEChERS extraction provided excellent recoveries with % RSDs below 2.

Figure 21.5

### Flow Chart of QuEChERS AOAC Sample Preparation Procedure<sup>5</sup>

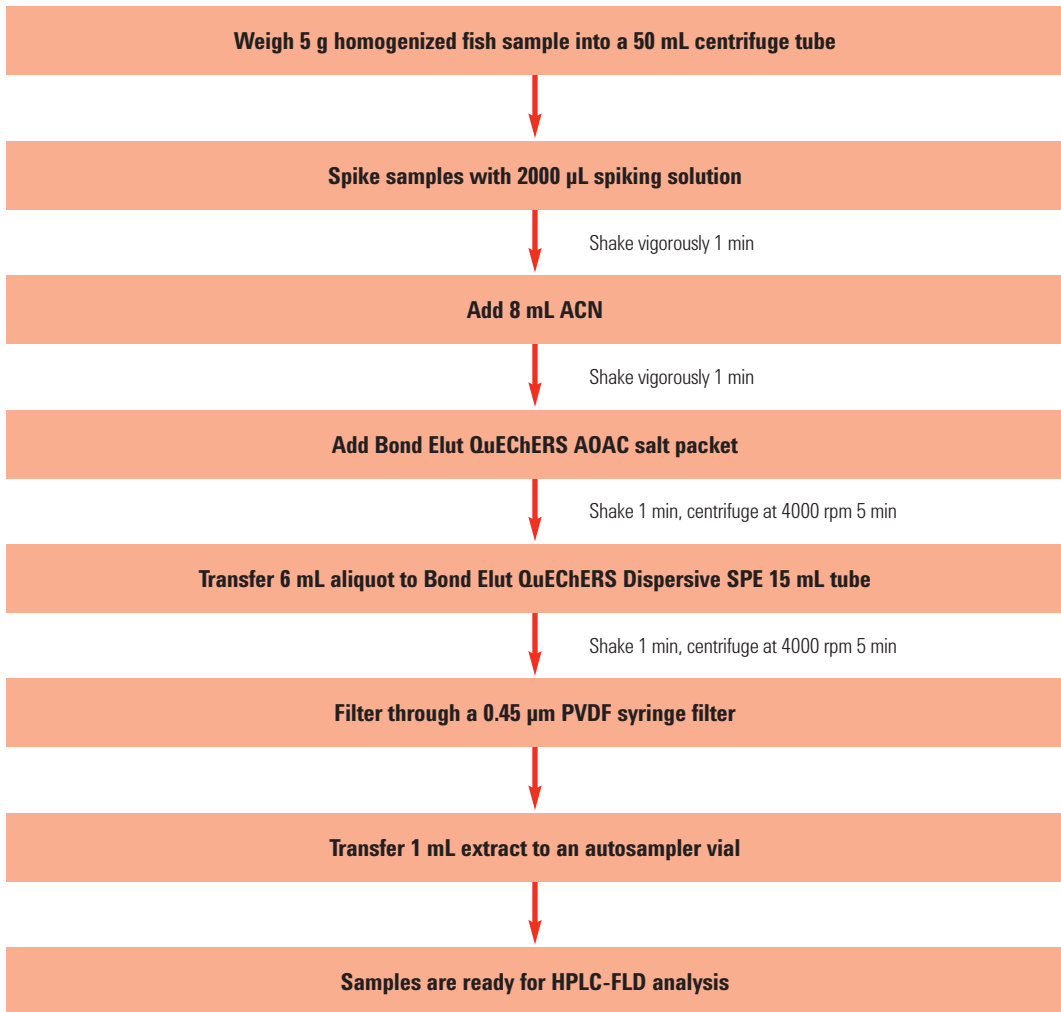
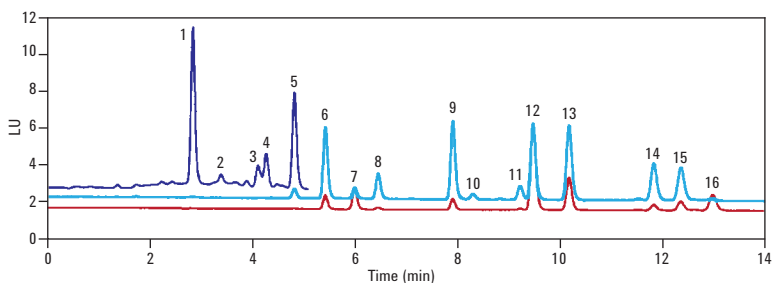

Figure 21.6

## HPLC-Fluorescence Chromatogram of Spiked Fish Extract



Overlay of HPLC-FLD chromatograms of spiked fish sample containing the following PAHs (at spiking levels shown in parens): 1. naphthalene (20 ng/g); 2. acenaphthylene (20 ng/g); 3. acenaphthene (10 ng/g); 4. fluorene (10 ng/g); 5. phenanthrene (10 ng/g); 6. anthracene (10 ng/g); 7. fluoranthene (10 ng/g); 8. pyrene (10 ng/g); 9. 1,2-benzanthracene (5 ng/g); 10. chrysene (10 ng/g); 11. benzo(e)acenaphthylene (5 ng/g); 12. benz(e)acenaphthylene (5 ng/g); 13. benzo(k)fluoranthene (5 ng/g); 14. dibenzo(a,h)anthracene (5 ng/g); 15. benzo(g,h,i)perylene (5 ng/g); and 16. indeno(1,2,3-cd)pyrene (5 ng/g); the black portion of the chromatogram used the following fluorescence excitation/emission wavelengths: 260 nm/352 nm; the red portion 260 nm/420 nm; the blue portion: 260 nm/440 nm. For acenaphthylene, UV detection at 230 nm was used.

### HPLC conditions

**Column:** Agilent ZORBAX Eclipse PAH C18, 4.6 x 50 mm, 1.8  $\mu$ m

**Flow rate:** 0.8 mL per minute

**Temperature:** 18  $^{\circ}$ C

**Injection volume:** 5  $\mu$ L

**Mobile phase:** A = deionized water, B = acetonitrile

#### Gradient:

Time (min):	%B
0	60
1.5	60
7	90
13	100

# Conclusions

The selectivity needed for the determination of targeted analytes in a complex matrix can be achieved anywhere in the analytical cycle. With a focus on the sample preparation portion, the concept of Just Enough sample preparation was presented. This concept relies heavily on the increased sensitivity and selectivity that can be achieved with tandem mass spectrometry coupled with chromatographic separation. Provided that ion suppression/enhancement contributions are held to a minimum, Just Enough sample preparation can provide the recoveries, minimum detectable limits (MDLs), and minimum detectable quantities (MDQs) consistent with the needs of the assay.

However, as illustrated in the example of PAH analysis in fish, other selective detection principles such as fluorescence can also be used. A note of caution: in some assays, sample processing (handling) is still the rate determining step and Just Enough sample preparation may be insufficient to meet the needs of the assay. In these cases, more sophisticated sample preparation protocols, such as SPE, liquid-liquid extraction, etc. may still be required.

## References

---

1. Majors, R.E. *LCGC No. America* **2012**, *30* (12), 1024-1031.
2. Turner, D. *LCGC No. America* **2012**, *30* (2), 100-110.
3. *Bioanalysis Application Note Determination of Fluticasone Propionate in Human Plasma*, Agilent Technologies Application Note #5990-6380EN, Santa Clara, CA, August, **2010**.
4. Anastasiades, M.; Lehotay, S. J.; Stajnbaher, D.; Schenck, F.J. *Journal of AOAC International (JAOAC)* **2003**, *86*, 412-431.
5. Pule, B.O.; Mmualefe, L.C.; Torto, N. *Analysis of Polycyclic Aromatic Hydrocarbons in Fish*, Agilent Technologies Application Note #5990-5441EN, Santa Clara, CA, **January, 2012**.



# Current Trends and Future Directions in Sample Preparation

Throughout this book, there are numerous citations on the vast number of improvements that have been made in the area of sample preparation for chromatography. Compared to a decade ago, many modern sample preparation techniques:

- Are faster
- Are safer
- Are easier to automate
- Have been miniaturized
- Use less organic solvent
- Equal or exceed sample recovery and reproducibility of older methods

However, in many circles, sample preparation is still considered to be the bottleneck in the analytical laboratory. Overall, it has not received the attention of academics that may consider sample preparation topics as too mundane and less challenging than focusing on the analysis itself. Nevertheless, workers in the field continue to develop new and improved sample preparation techniques some of which may provide breakaway performance and acceptance as mainstay, routine methodologies such as solid-phase microextraction (SPME), QuEChERS, and pressurized fluid extraction.

Accepted techniques find new applications such as the use of QuEChERS outside of the pesticide in fruits and vegetables domain, solid-phase microextraction in remote sampling, or dried blood spotting to other biological fluids. New sorbents for liquid-solid extractions continue to be developed such as the very selective molecularly imprinted polymers and immunosorbent phases. Entirely new techniques such as dispersive liquid-liquid microextraction, ionic-liquid extraction, and microscale salting out liquid-liquid extraction could become the next well accepted technique like solid-phase extraction. Automation of many of the time-consuming sample preparation techniques have been advancing in recent years, freeing up the analyst to spend time performing more challenging tasks. Full laboratory robotic systems of the 90's have given way to x-y-z benchtop liquid handling systems which are closer to and often integrated with the analytical instrument. Autosamplers with sample preparation capabilities beyond injection have been around for a few years and have proven to be useful for the last few crucial steps prior to injection. Sometimes, for liquid and solid samples, these autosamplers and benchtop sample preparation systems can provide a complete level of automation, even weighing the sample.

As was amply pointed out in Chapter 21, the increasing sensitivity/selectivity of mass spectrometers and more efficient and selective chromatographic separations have, in some cases, provided the selectivity that, in the past, rested on the shoulders of the sample preparation chemist. Thus, developing an analytical method that combines the optimized elements of sampling, sample preparation, analysis, detection, and even data analysis can provide a more encompassing robust solution for complex samples. The increasing popularity of multidimensional on-line column switching systems with orthogonal separation modes can provide a sample prep/analysis solution where method development may be faster and more selective than spending hours developing the optimum sample preparation technique.

The whole idea of further miniaturization driven by increased instrument sensitivity can reward the analyst in more ways than one. Smaller sample amounts are now required. Using 96-well flow-through SPE plates with each well containing only a few milligrams of sorbent not only speeds up the extraction time, but requires only a few microliters of elution solvent. Thus, solvent evaporation and reconstitution time is remarkably sped up. Using 96-well evaporation systems and plate handlers, sample preparation no longer becomes the rate-determining step and high-throughput sample handling is now becoming commonplace. And to top it off, the amount of solvent used is decreased proportionally to the level of miniaturization thereby lowering purchase and disposal costs. Although chip-based analysis systems are still not in routine use, there is no reason not to believe that down the road, such integrated systems may take the place of instruments now consuming entire laboratory benches. Field-portable analytical instruments, some with simple sample prep capabilities, are already in use and support a trend to bring the analysis closer to the source or to the manufacturing floor.

While we are on the topic of miniaturization, the future for nanomaterials in sample preparation looks very bright. Due to the "nanoscale" effect, nanomaterials have unique physical and chemical properties that make them superior candidates as sorbents. A wide variety of nanoparticles (e.g. metallic, metallic oxide, metal organic framework, siliceous and carbonaceous such as grapheme and carbon nanotubes) have been the subject of widespread studies, not only as  $\mu$ -SPE sorbents but also as coatings for SPME rods and fibers. In the latter case, immobilized nanoparticles appear to be as rugged as existing polymeric phases, have a higher surface area for increased sensitivity, and can be derivatized to impart new chemistries. Particularly interesting are the magnetic SPE particles that are directly dispersed into sample solutions to quickly extract analytes since they can be readily recovered by a magnet. Magnetic handling overcomes the problems of conventional SPE, such as eliminating packing of cartridges or plates, or the time consuming process of loading large volume of liquid samples.

Green chemistry has been discussed for a long time and there is some evidence that it is catching on in some large companies and institutions, not only in the manufacturing environment, but also in the chemistry laboratory. In the analytical and separations laboratory, green chemistry not only means changing solvents to more environmentally friendly and safer ones, but in reducing solvent consumption, reducing energy consumption, and considering solventless sample preparation techniques. In the latter consideration, SPME, single-drop microextraction, superheated water extraction, and supercritical fluid extraction (and chromatography) are just a few of the techniques that almost eliminate the use of conventional organic solvents. The jury is still out on the increased promotion of ionic liquids and eutectic solvents for greener extractions.



# Glossary

<b>96-well collection plate</b>	A fixed size polyethylene rectangular plate (127.8 mm x 85.5 mm) consisting of an array of 8 x 12 (96) small "test tubes" called wells; volumes of wells range from 0.5-2 mL; see Chapter 9.
<b>96-well filtration plate</b>	A fixed size polyethylene rectangular plate (127.8 mm x 85.5 mm) consisting of an array of 8 x 12 (96) small filter tubes (volumes range from 0.5-2 mL); a membrane filter placed at the bottom of the well is used to filter liquid samples; sometimes a prefilter is placed above the membrane filter to prevent clogging with particulate samples; see Chapter 5.
<b>96-well plate</b>	A small, rectangular plastic plate consisting of 96-well individual wells which are small volume test tubes arranged in an 8 x 12 well pattern; used for liquid handling and other such requirements; see Chapters 5 and 9.
<b>96-well solid phase extraction plate</b>	A small, rectangular plastic plate consisting of 96-well individual flow-through SPE wells arranged in an 8 x 12 array that have top and bottom frits to contain solid particles of sorbent or resin to perform SPE on a miniaturized scale; generally 1 mg-0.2 g of packing are placed into the well which can be up to 2 mL volume; used for automated SPE with x-y-z liquid handling systems or customized workstations; see Chapter 9.
<b>Accelerated solvent extraction</b>	Tradename for a Pressurized Fluid Extraction System introduced by Dionex and now sold by ThermoFisher Scientific; see pressurized fluid extraction in Chapter 14.
<b>ACN</b>	Abbreviation for acetonitrile, a popular solvent for reversed-phase LC as well as sample preparation.
<b>Active sampling</b>	In active gas sampling, a pump is used to push the sample through a mass flow controller and into the canister. Additional sample can be collected, relative to the amount that can be collected by passive sampling, by pressurizing the canister with sample. Commonly, the sample is pressurized to 15 psig, effectively doubling the sample volume.
<b>Active site</b>	A reactive or strongly attracting site on the surface of a chromatographic packing that may bind analytes or cause peak tailing; sometimes mobile phase additives (e.g. competing base) can negate the effects of active sites.
<b>Additive</b>	A substance added to the mobile phase to improve the separation or detection characteristics; examples would be a competing base to negate the effects of silanols, a chelating agent to block metal sites or addition of a UV-absorbing compound to perform indirect photometric detection.
<b>Adsorbent</b>	Packing used in adsorption chromatography. Silica gel and alumina are the most frequently used adsorbents in HPLC and sample preparation.

<b>Adsorption</b>	The process of retention in which the interactions between the solute and the surface of an adsorbent dominate. The forces can be strong forces (for example, hydrogen bonds) or weak (van der Waal's forces). For silica gel, the silanol group is the driving force for adsorption and any solute functional group which can interact with this group can be retained on silica. The term adsorption places emphasis on the surface vs. penetration or embedding in the stationary phase coated or bonded to a surface; see Chapters 9 and 10.
<b>Adsorption chromatography</b>	One of the basic LC and SPE modes which relies upon the adsorption process to effect the separation. Silica gel and alumina are the most frequently used normal phase adsorbents and molecules are retained by the interaction of their polar function groups with the surface functional groups (e.g. silanols of silica). Carbon is also used as an adsorbent in a reversed-phase mode; see Chapters 9 and 10.
<b>Adsorption isotherm</b>	In adsorption, a plot of the equilibrium concentration of sample in the mobile phase per unit volume versus the concentration in the stationary phase per unit weight. The shape of the adsorption isotherm can determine the chromatographic behavior of the solute such as tailing, fronting, overload, etc.
<b>Affinity chromatography</b>	A technique in which a biospecific adsorbent is prepared by coupling a specific ligand (such as an enzyme, antigen, or hormone) for the macromolecule of interest to a solid support (or carrier). This immobilized ligand will interact only with molecules that can selectively bind to it. Molecules that will not bind elute unretained. The retained compound can later be released in a purified state. Affinity chromatography is normally practiced as an "on-off" separation technique; see Chapter 10.
<b>Alumina</b>	A normal phase adsorbent used in adsorption chromatography. Aluminium oxide ( $Al_2O_3$ ) is a porous adsorbent which is available with a slightly basic surface; neutral and acidic modifications can also be made. Basic alumina can have advantages over silica, which is considered to have an acidic surface; alumina is seldom used as an HPLC column packing in practice; see Chapter 9.
<b>Amino phase</b>	A phase used in normal bonded phase chromatography which is a propylamino phase. It is a somewhat reactive phase for any solute molecule (e.g. aldehydes) or mobile phase additive that can react with amines. The amino phase has found some applications as a weak anion exchanger and for the separation of carbohydrates using a water-acetonitrile mobile phase. It is a relatively unstable phase; see Chapter 9.
<b>Amphoteric ion exchange resin</b>	Ion exchange resins that have both positive and negative ionic groups. These resins are most useful for ion retardation in which all ionic materials can be removed from solution since the anionic and cationic functionalities coexist on the same material; see Chapter 9.
<b>Analyte</b>	The compound of interest to be analyzed by injection into and elution from an HPLC or GC column.
<b>Analyte protectant</b>	In GC, a chemical compound that is added to a sample before injection to cut down on interactions between analytes that are unstable or behave poorly in the GC flow path on active sites; the protectants are chosen so that they do not interfere with the analysis of the compounds of interest yet prevent these compounds from interacting with the active sites in the flow path; these protectants are not generally required for LC and LC/MS; see Chapter 8.

<b>Anion exchange</b>	The ion exchange procedure used for the separation of anions. Synthetic resins, bonded phase silicas and other metal oxides are available for this mode. A typical anion exchange functional group is the tetraalkylammonium making a strong anion exchanger. An amino group on a bonded stationary phase would be an example of a weak anion exchanger; see Chapter 9.
<b>Argentation SPE</b>	The incorporation of a silver salt into the SPE stationary phase will help in retaining compounds with olefinic bonds. Normally used in organic solvents to maximize charge-transfer interactions; see Chapter 10.
<b>Array 96-well plate</b>	A 96-well SPE plate in which the 96 individual wells are removable from the base plate; such a setup allows the user to place different types and amounts of SPE sorbents into his/her own configuration in each of the 96-wells. This type of 96-well plate has also been referred to as a flexible 96-well plate configuration; see Chapter 9.
<b>Back extraction</b>	Use in liquid-liquid extraction to perform an additional extraction to further purify a sample; initially the extraction may take place with an aqueous solvent buffered at a high pH and an immiscible organic solvent; once the initial extraction takes place and interferences are removed, then by having another aqueous solution at a low pH, one can back extract the analyte into the organic layer based on the analyte now being in a neutral form. An example would be for the cleanup of an acidic substance containing -COOH groups; at high pH the carboxyl would be ionized and prefer the aqueous layer and impurities may migrate to the organic phase and be discarded; then the pH of the aqueous layer can be adjusted to a low value. Now the carboxyl group is in an unionized form and readily extracted into the organic layer as a purified substance; see Chapter 7.
<b>Backflushing</b>	A column switching technique in which, for LC a four-way valve placed between the injector and the column allows for mobile phase flow in either direction. In GC, pressure (or Deans) switching is used to control the direction of flow. Backflushing is used to elute strongly held compounds at the head of the column. It can be used for analysis of these compounds or merely to remove them from the column. By reversing the flow at the conclusion of a run, the analytes trapped at the head of the column can be flushed from the column since they have a shorter distance to travel; sometimes a strong solvent (LC) or higher temperature and/or flow rate (GC) will be needed to move them along; see Chapters 6, 9, 10, 13 and 21.
<b>Bar coding</b>	A bar code is an optical machine-readable representation of data relating to the object to which it is attached. Bar codes are sometimes used in chromatographic automation to track the sample through the analytical process; bar code strips can be adhered to vials, beakers, or other containers; vials can sometimes be given permanent bar codes; more recently, universal product codes and RFI tags have been proposed; bar code readers are available for autosamplers to aid in the sample tracking process; they are generally interfaced directly to the data system.
<b>Bind-elute</b>	In SPE, the normal mode of operation in which upon loading the sample onto a conditioned sorbent or resin, the analytes of interest are retained (bound) while interferences, and perhaps some of the matrix, is not retained by the packing; after a wash step to remove some of the undesired sample components, the elute step uses a strong solvent to elute the analyte(s) of interest in a small volume; see Chapter 9.
<b>Blank</b>	More correctly named <i>method blank</i> : a blank prepared to represent the matrix as closely as possible. The method blank is prepared/extracted/digested and analyzed exactly like the field samples. Purpose: assess contamination introduced during SP activities.

<b>Blending</b>	Refers to the process of making a heterogeneous sample into a more consistent and uniform sample by some type of blending operation; the most popular type of blender is the mechanical blender that chops a semi-soft material into smaller parts; see Chapters 4 and 16.
<b>Bonded phase</b>	A stationary phase which is covalently bonded to the support particles or inside the wall of a tube (capillary).
<b>Box car chromatography</b>	See <i>column switching</i> ; alternate name.
<b>Breakthrough capacity</b>	See <i>breakthrough volume</i> .
<b>Breakthrough volume</b>	The volume at which a particular solute pumped continuously through a column will begin to elute. It is related to the column volume plus the retention factor of the solute. It is useful to determine the total sample capacity of the column for a particular solute; see Chapter 9.
<b>Buffer</b>	A solution that maintains constant pH by resisting changes in pH as a result of dilution or addition of small amounts of acids and bases.
<b>Buffer strength</b>	See <i>ionic strength</i> .
<b>C4, C8, C18, etc.</b>	Refers to the alkyl chain length of a reversed bonded phase.
<b>Canister collection</b>	A stainless steel vessel designed to hold vacuum to less than 10 mTorr or pressure to 40 psig. Canisters are available in a range of volumes: 400 mL, 1.0 L, 3.0 L, 6.0 L, and 15 L. The size of canister used usually depends on the concentration of the analytes in the sample, sampling time, flow rate, and sample volume required for the sampling period. Typically, smaller canisters are used for more concentrated samples, such as soil gas collection, 3 L and 6 L canisters are used to obtain integrated (TWA) ambient air samples at sampling times of up to 24 hours, and large 15 L canisters are used for reference standards. Sampling time will be limited by the combination of canister size and the flow rate at which the sample is to be collected; see Chapter 6.
<b>Capacity factor</b>	A chromatographic parameter that measures the degree of retention. See $k'$ for calculation method. Now referred to as $k$ , the retention factor (IUPAC).
<b>Carbon load</b>	For a bonded phase silica, term usually used to describe the surface coverage or the degree to which the available silanols on the column packing's surface have reacted and been replaced with the bonded phase; the higher the carbon load, the lower number of residual silanols. The carbon load is normally expressed as a % carbon (e.g. 12% carbon). In reversed-phase LC or SPE, the higher the carbon load, the greater the analyte retention.
<b>Cartridge</b>	Generally refers to the container used in SPE or filtration; a cartridge may be as simple as a medical grade syringe barrel which is filled with packing contained at both ends by frits; it can also be a molded device or even a stainless steel device that contains similar sorts of packing material. In SPE, the device is also referred to as an SPE tube; see Chapters 4 and 9.
<b>Cation exchange chromatography</b>	The form of ion exchange chromatography that uses resins or packings with functional groups that can separate cations. An example of a strong cation functional group would be a sulfonic acid; a weak cation exchange functional group would be a carboxylic acid; see Chapters 9 and 10.

<b>Centrifugation</b>	A process that involves the use of the centrifugal force for the sedimentation of mixtures with a centrifuge (see centrifuge). This process is used to separate two immiscible liquids. More-dense components of the mixture migrate away from the axis of the centrifuge, while less-dense components of the mixture migrate towards the axis. Chemists and biologists may increase the effective gravitational force on a test tube so as to more rapidly and completely cause the precipitate ("pellet") to gather on the bottom of the tube. The remaining solution is properly called the "supernate" or "supernatant liquid." The supernatant liquid is then either quickly decanted from the tube without disturbing the precipitate, or withdrawn with a Pasteur pipette; see Chapters 1, 2, 4, 5, 7, 8, 9, 10, 14, 15, 16 and 21.
<b>Centrifuge</b>	A piece of equipment generally driven by an electric motor (some older models were spun by hand), that puts an object in rotation around a fixed axis, applying a force perpendicular to the axis; see <i>centrifugation</i> .
<b>Certify</b>	SPE products for drugs of abuse analysis; see Chapter 10.
<b>Chain length</b>	The length of carbon chain in the hydrocarbon portion of a reversed-phase packing. It is expressed as the number of carbon atoms (e.g. C8, C18). Specifically excludes the short chains typical methyl, isopropyl, and sec-butyl groups also attached to the silane.
<b>Chelating resin</b>	Contains functional groups that will interact with cationic species (e.g. metals such as copper, iron, heavy metal ions); useful for concentrating trace quantities or for separation.
<b>Chemical filtration</b>	A liquid sample is passed through a packing material (e.g. adsorbent, ion exchange, etc.) that selectively interacts with one or more compounds within the sample and acts as a chemical way to remove and purify the liquid sample. Regular filtration does not involve any chemical interaction but merely removes particulates; see Chapter 4.
<b>Chemisorption</b>	Sorption due to a chemical reaction with the packing. Most such interactions are irreversible. Usually occurs on packings with reactive functional groups such as silanol or bonded amino phases. Chemisorption is common with metal oxide phases that have strong Lewis acid sites.
<b>Chopping</b>	The process of mechanically cutting a sample into smaller parts; see Chapter 4.
<b>Co-ion</b>	An ion of the same sign of charge as the ionic groups making up the stationary phase.
<b>Column switching</b>	The use of multiple columns connected by switching valves to effect better chromatographic separations or for sample cleanup. Fractions from a primary column can be switched to two or more secondary columns, which in turn can be further diverted to additional columns or to the detector(s); sometimes referred to as multidimensional chromatography; see Chapters 10, 11 and 13.
<b>Concentration</b>	The process of increasing the strength or density of a diluted sample; a more concentrated sample will be easier to measure; concentration can be accomplished by a wide variety of sample prep techniques such as evaporation, adsorption, diffusion, etc.



**Conditioning (SPE)**

Generally considered to be the first step in SPE; the stationary phase must first be put into a chemical/physical state so that it can accept the sample solution loaded in the second SPE step; a conditioning solvent is passed through the SPE stationary phase where it will solvate the phase so that it will more easily sorb the sample of interest; for a reversed-phase SPE cartridge, methanol or acetonitrile serves as a conditioning solvent; sometimes the excess conditioning solvent must be removed but the packing shouldn't be allowed to dry out since that may affect the "conditioned" phase; see Chapter 9.

**Coning and quartering**

A sample size reduction technique in which a portion of free-flowing solid material (powder) is systematically divided into quadrants in order to achieve a statistically representative sample. A method used by analytical chemists to reduce the sample size of a powder without creating a systematic bias. The technique involves pouring the sample so that it takes on a conical shape, and then flattening it out into a cake. The cake is then divided into quarters; the two quarters which sit opposite one another are discarded, while the other two are combined and constitute the reduced sample. The same process is continued until an appropriate sample size remains. Analyses are made with respect to the sample left behind; see Chapter 4 .

**Continuous liquid-liquid extraction**

Useful when the  $K_D$  value is very low or the required sample volume is very large when multiple extractions are impractical; also if the extraction is slow, a long time may be required for equilibrium to be established; in continuous LLE, fresh solvent is continually recycled through the aqueous sample; continuous extractors are available for heavier-than-water and lighter-than-water solvents; see Chapter 7.

**Cool on-column injection**

A technique of introducing a sample as a liquid directly into a GC column; this lack of prior vaporization offers the following advantages: 1) Eliminates sample discrimination; 2) Eliminates sample alteration; and 3) Provides high analytical precision. However, there are some special requirements: 1) Requires relatively clean samples; 2) Real samples are often too concentrated for on-column injection and must be diluted; and 3) Peak splitting or peak distortion can occur due to differing polarities of solvent, stationary phase, and solutes; see Chapter 6.

**Counter-ion**

In an ion exchange process, the ion in solution used to displace the ion of interest from the ionic site. In ion pairing, it is the ion of opposite charge added to the mobile phase to form a neutral ion pair in solution.

**Coupled columns**

A form of column switching that uses a primary column connected to two secondary columns via a selector valve. Fractions from column 1 can be selectively transferred to columns 2 and 3 for additional separation to occur. Term also used to describe two or more columns connected in series to provide an increased number of plates; see Chapter 13.

**Coverage**

Refers to the amount of bonded phase on a silica support in bonded phase chromatography. Coverage is usually described in  $\mu\text{moles per m}^2$  or in terms of %C (W/W).

**Crash plate**

Refers to the process of precipitating protein from plasma by the addition of a miscible organic solvent such as acetonitrile; when a 96-well flow-through or fixed-well plate is used for this process, it is referred to as crashing and the plate a crash plate; see Chapter 16.

<b>Crosslinking</b>	For resins, during the process of copolymerization to form a three-dimensional matrix, a difunctional monomer is added in order to form crosslinkages between adjacent polymer chains. The degree of crosslinking is determined by the amount of this monomer added to the reaction. For example, divinylbenzene is a typical crosslinking agent for the production of polystyrene ion exchange resins. The swelling and diffusion characteristics of a resin are governed by its degree of crosslinking.
<b>Crushing</b>	Tungsten-carbide variable jaw crushers for reducing the size of large, extremely hard, brittle samples; see Chapter 4.
<b>Cutting</b>	Cutting mills can reduce soft-to-medium hard materials (<100 mm diameter); see Chapter 4.
<b>Cyano phase</b>	A chemically bonded phase that terminates with the -CN functional group; can be used in normal phase as a moderate polarity sorbent and in reversed-phase as a short chain bonded phase.
<b>Deep well plate</b>	A 96-well plate capable of handling up to 2 mL of liquid volume per well; see Chapter 9.
<b>Derivatization</b>	A technique used in chemistry which transforms a chemical compound into a product (the reaction's derivate) of similar chemical structure, called a derivative. Generally, a specific functional group of the compound participates in the derivatization reaction and transforms the compound(s) into one with a different reactivity, solubility, boiling point (volatility), melting point, aggregate state, or chemical composition. The resulting new chemical properties can be used for quantification (e.g. UV or fluorescence detection) or better separation properties; see Chapter 20.
<b>Desalting</b>	Technique in which low molecular weight salts and other compounds can be removed from non-ionic and high molecular weight compounds. For example, use of a reversed-phase packing to retain sample compounds by hydrophobic effects, yet allow salts to pass through unretained would be an example of desalting. Use of an SEC column to exclude large molecules and retain lower molecular weight salts is another example; desalting using dialysis is commonly used in protein purification; see Chapters 9, 11, and 15.
<b>Desorption</b>	The process in chromatography or SPE when a molecule residing on the surface of a packing material or another solid surface (e.g. column wall, frit, etc.) or stationary phase moves from the surface into the mobile phase.
<b>Dialysis</b>	Works on the principles of the diffusion of solutes and ultrafiltration of fluid across a semi-permeable membrane. Diffusion is a property of substances in water, which tend to move from an area of high concentration to an area of low concentration. A semi-permeable membrane is a thin layer of material that contains holes of various sizes, or pores. Smaller solutes and fluid pass through the membrane, but the membrane blocks the passage of larger substances (for example, red blood cells, large proteins). A technique used in biological sample prep to desalt biological fluids; see Chapters 15 and 18.

<b>Diatomaceous earth</b>	Also known as diatomite or kieselgur/kieselguhr, is a naturally occurring, soft, siliceous sedimentary rock that is easily crumbled into a fine white to off-white powder. Diatomaceous earth consists of fossilized remains of diatoms, a type of hard-shelled algae. It has a particle size ranging from less than 3 micrometers to more than 1 millimeter, but typically 10 to 200 micrometers. Depending on the granularity, this powder can have an abrasive feel, similar to pumice powder, and is very light as a result of its high porosity. The typical chemical composition of oven-dried diatomaceous earth is 80 to 90% silica, with 2 to 4% alumina (attributed mostly to clay minerals) and 0.5 to 2% iron oxide; highly purified diatomaceous earth is used as a support for chromatography and for supported liquid-liquid extraction, see Chapter 7.
<b>Diethylaminoethyl</b>	A popular weak anion exchange functionality (typically attached to cellulose or Sepharose, a product of GE Healthcare) used for the separation of biomolecules; functionality has also been attached to other polymeric materials and silica gel.
<b>Digestion</b>	The process of treating an insoluble chemical compound with a reactive substance (e.g. for inorganic compounds it might be a strong acid; for a biological compound it might be an enzyme) that will break it down or disintegrate the compound into a more soluble form that can be further treated or analyzed; see Chapters 2, 15 and 16.
<b>Digital chromatography</b>	The process of solid phase extraction (SPE) is sometimes referred to as digital chromatography – a substance is either on the SPE stationary phase or is off the stationary phase during its retention/elution; in chromatography, we are often trying to resolve closely related substances by exploiting subtle differences in retention in more of an analog separation mode; in terms of $k$ values, ideally the solute in SPE has a value of infinity when on the sorbent and zero when eluted into solution; see Chapter 9.
<b>Dilute and shoot</b>	A simple sample prep procedure in which one merely dilutes the sample with solvent, mobile phase, or a compatible liquid, and then injects the diluted sample into a chromatograph without any further sample preparation; see Chapters 2, 16 and 21.
<b>Dilution</b>	Reducing the concentration of a chemical by adding an inert substance; the substance can be a liquid, solid, or gas.
<b>Diol phase</b>	A hydrophilic phase useful in both normal and reversed-phase. It consists of a diol structure (two -OH groups on adjacent carbon atoms in an aliphatic chain). In normal phase work, it is less polar than silica, and in reversed-phase work, has been used for the separation of proteins and polypeptides; see Chapters 9, 10 and 16.
<b>Direct sampling</b>	A method of sample collection in which a sample is taken directly from the source. For example, a canister may be used to collect a gas sample exactly at its source. A river water sample can be obtained by lowering a collection vessel directly into the water. A thermal desorption tube can be used to concentrate volatile and semi-volatile analytes by passing a gas stream through the adsorbent contained within the tube.

**Direct thermal sampling**

The process of using temperature as a variable in sample volatile and semi-volatile substances; static headspace at a given temperature is an example of thermal sampling; by selecting a certain temperature, certain sample components can be ruled out since they may have extremely low volatility at a selected temperature; thermal sampling can occur in stages all the way up to pyrolysis when chemical bonds in the sample are purposely broken in order to access the structure of the material; see Chapter 6.

**Disk**

A number of SP and separation media take the form of a disk; the most popular disks are used in filtration and may consist of any number of porous polymeric materials; the most popular types of SPE disks would have embedded particles in a disk made of PTFE or other inert polymeric material, or a fiberglass matrix with interdispersed sorbent particles; some biological purification media employ the disk format. The stationary phases may contain ion exchange groups or other functionality that attracts solutes of interest or impurity that one may want to discard; see Chapter 9.

**Disk cartridge (SPE)**

See *disk*.

**Dispersive liquid-liquid microextraction**

Technique based on a three-component solvent system. The container is usually a centrifuge tube and the appropriate mixture of immiscible organic extraction solvent (usually a few microliters such as 8  $\mu$ L of tetrachloroethylene, TCE) and a dispersive solvent (e.g.  $\sim$  1 mL of acetone) is rapidly injected with a syringe into an aqueous solution ( $\sim$  5 mL) containing the analyte of interest. When the 3 solvents are rapidly mixed, a cloudy solution is formed consisting of droplets of extraction solvent; the entire mixture is centrifuged and the droplet of solvent containing extracted analytes (TCE) is removed by a microsyringe for direct injection. Extraction is almost instantaneous and enrichment values are quite high; see Chapter 7.

**Dispersive SPE**

Method in which loose SPE packing material is added directly to a solution rather than passing it through the packed material in a cartridge or tube; most often used as the second step in QuEChERS when matrix compounds are removed from the organic solvent salting out extraction of step 1; see Chapter 8.

**Disposable filter**

See *syringe filter*; see Chapter 5.

**Dissolution**

The process of having a sample dissolve in an appropriate solvent.

**Distillation**

A method of separating mixtures based on differences in volatility of components in a boiling liquid mixture. Distillation is a unit operation, or a physical separation process, and not a chemical reaction; it can be used to purify organic compounds or to remove solvent; fractional distillation is used to separate compounds with close boiling points; azeotropic distillation is using an azeotrope to remove a solvent that has a boiling point too close or equal to another compound that cannot be separated.

**Distribution constant (coefficient) ( $K_c$ )**

The equilibrium concentration of a component in or on the stationary phase divided by the equilibrium concentration of the component in the mobile phase; also called the distribution coefficient or in partition chromatography the partition coefficient; in partition chromatography  $K_c$  is used and refers to the case in which the concentration in the stationary phase is expressed per unit volume of the phase ( $V_R = V_M + K_c V_S$ ); in the case of a solid stationary phase,  $K_g$  is used and is expressed as per mass (weight) of the dry solid phase; in the case of adsorption chromatography with a well characterized adsorbent of known surface area, the concentration in the stationary phase is expressed as per unit surface area.

**Dividers**

A mechanical device used in subdividing solid powder samples into smaller units; they can be manual or automated; sample dividers will subdivide material samples into two smaller portions by a single pass or further subdivisions can be attained by multiple passes. The important feature sample dividers is that each subdivision retains the characteristics of the original sample; see Chapter 4.

**Dried blood spot analysis**

A newer method for sampling and transporting blood samples; a small (~15  $\mu$ L) sample of whole blood is placed on a cellulose or other paperlike material and is dried for 2 hours; the dried blood spot can be extracted to remove analytes of interest for further workup; has potential to replace drawing large quantities for blood analysis; used in conjunction with LC-MS/MS for high sensitivity and specificity; see Chapter 16.

**Dried media spot analysis**

In addition to DBS, other biological fluids (e.g. plasma, serum, CSF, saliva) as well as other non-biological liquid samples have been investigated; see Chapter 16.

**Drying**

Drying of sample extracts can be accomplished by heating (evaporation), vacuum desiccation, and other means; water can be removed (dried) from organic solvents by using anhydrous sodium sulfate; see Chapter 4.

**Dynamic headspace**

See *purge and trap*; see Chapter 6.

**Electrodialysis**

Used to transport salt ions from one solution through ion exchange membranes to another solution under the influence of an applied electric potential difference. This is done in a configuration called an electrodialysis cell. The cell consists of a feed (diluate) compartment and a concentrate (brine) compartment formed by an anion exchange membrane and a cation exchange membrane placed between two electrodes; can provide good enrichment factors; see Chapters 15 and 18.

**Eluotropic series**

A series of solvents (eluents) with an increasing degree of solvent strength generally used in LSC or adsorption chromatography. In normal phase chromatography and SPE, a non-polar solvent such as pentane would be at one end of the scale, an intermediate solvent such as dichloromethane would be in the middle of the scale, and a strongly polar solvent such as methanol would be near the upper end of the scale. In NPC, the reverse order of strength would be observed; water would be weak and hexane strong. Thus, when developing a method or running a gradient, an eluotropic series is useful for selecting solvents.

<b>Elution step (SPE)</b>	Generally considered to be the fourth step in SPE and occurs after the washing (rinsing) step; in the elution step, analytes are removed from the SPE stationary phase by elution with a strong solvent so that the analytes are now in a concentrated state; often, the strong solvent is removed by evaporation and reconstituted in a solvent more compatible with the chromatographic system; see Chapter 9.
<b>Emulsion</b>	A mixture of two or more liquids that are normally immiscible (nonmixable or unblendable). Emulsion is usually referred to when both the dispersed and the continuous phase are liquids. In an emulsion, one liquid (the dispersed phase) is dispersed in the other (the continuous phase). Emulsions are bothersome in LLE since they sometimes are hard to break so that the layers can be separated and further treated, if necessary. There are numerous ways to break emulsions; see Chapter 8.
<b>End capping</b>	A technique used to remove silanol groups on silica gel that may remain after reaction with a large silylating agent such as octadecyltrichlorosilane. The column is said to be endcapped when a small silylating reagent (e.g. trimethylchlorosilane, and dichlorodimethylsilane) is used to bond residual silanol groups on a silica gel-based packing surface. Most often used with reversed-phase packings to minimize undesirable adsorption of basic, ionizable and ionic compounds. For polymeric phases with terminal silanol groups, endcapping reactions are also used to remove them.
<b>Evaporation</b>	The process of removing a volatile compound for the purposes of isolating a compound of interest; solvent evaporation is one of the most often used sample preparation techniques.
<b>Exchange capacity</b>	See <i>ion exchange capacity</i> ; see Chapter 9.
<b>Exclusion chromatography</b>	See size exclusion chromatography and ion exclusion chromatography; see Chapters 11, 15 and 16.
<b>Exclusion limit</b>	In SEC, the upper limit of molecular weight (or size) beyond which molecules will elute at the same retention volume, called the exclusion volume. Many SEC packings are referred to by their exclusion limit. For example, a 10 <sup>5</sup> column of porous silica gel will exclude any compounds with a molecular weight over 100,000, based on a polystyrene calibration standard; see Chapter 11.
<b>Exclusion volume</b>	The minimum retention volume of a molecule on an SEC packing in which all molecules larger than the size of the largest pore are totally excluded. These molecules are incapable of penetrating the pores and elute at the interstitial (interparticle) volume of the column; see Chapter 11.
<b>Extraction</b>	The general term for removing analytes of interest from a matrix.
<b>Fiberglass disks (SPE)</b>	A format in which SPE particles are embedded in a fiberglass matrix; the disk format is especially useful for processing large volumes of sample (e.g. water) since the larger cross sectional area allows for high flow rate than can be used for a typical cartridge; see Chapter 9.

<b>Filter funnel</b>	A laboratory funnel used for separating solids from liquids via the laboratory process of filtering. In order to achieve this, a disk-shaped piece of filter paper is usually folded into a cone and placed within the funnel. The suspension of solid and liquid is then poured through the funnel. The solid particles are too large to pass through the filter paper and are left on the paper, while the much smaller liquid molecules pass through the paper to a vessel positioned below the funnel, producing a filtrate. The filter paper is used only once. If only the liquid is of interest, the paper is discarded; if the suspension is of interest, both the solid residue on the paper and the filtrate are kept for further analysis; see Chapter 5.
<b>Filter holder</b>	Membrane filter or membrane disk are sometimes furnished loose and can be placed in a holder (usually of stainless steel construction) for processing samples; once the filter is used, the holder is opened and the used filter replaced with a fresh one; see Chapter 5.
<b>Filter porosity</b>	Pore size relates to the filter's ability to filter out particles of a certain size. For example, a .05 micron ( $\mu\text{m}$ ) membrane will filter out particles with a diameter of .05 $\mu\text{m}$ or larger from a filtration stream. Filter porosity is typically not related to – nor controlled by – pore size. These two parameters are essentially independent. Porosity is also unrelated to thickness. Rather, it is a function of the polymer and casting process used in the manufacture of the filter; see Chapter 5.
<b>Filter vial</b>	A membrane filter unit that consists of two pieces: the filtration plunger, which contains a membrane filter suitable for the solvent being filtered; the second part of the filter vial is the vial body itself; once the sample is loaded and filtered, the filter vial can be placed directly in the autosampler without transferring the filtered sample to another vial; see Chapter 5.
<b>Filtration</b>	The process of passing a liquid through a paper, membrane, glass, or other type of filter for the purposes of removing particulates that could cause problems downstream during a chromatographic analysis; a chemical filter also removes certain chemical species; see chemical filtration; see Chapter 5.
<b>Fixed well plate</b>	A 96-well plate with fixed (non-removable) wells, not an array; see <i>96-well plate</i> and <i>array 96-well plate</i> .
<b>Flash chromatography</b>	A very fast form of classical liquid chromatography used by synthetic organic chemists to effect rapid purification. Done primarily in the normal phase mode, sometimes with RPC; see Chapter 12.
<b>Flexible well plate</b>	See <i>array 96-well plate</i> .
<b>Flow injection extraction</b>	An on-line extraction technique in which a sample is injected as a plug into an aqueous flow stream that is divided into small segments by an organic phase; the aqueous and organic segments are mixed during their passage down a coil and eventually the phases are separated at the end by a special fitting and the amount of extract compound can be measured in the organic phase; see Chapter 7.
<b>Fluoro-phase</b>	One of a family of aliphatic and aromatic reversed-phase materials in which a substantial fraction of the bonded phase is fluorinated. Sometimes called fluorinated phases or perfluoro phases. Typically have different selectivities than hydrocarbon phases.

<b>Fluted filter paper</b>	Filter paper which is folded in a systematic manner to allow more air space in the filter funnel; this allows liquid to flow faster through the filter paper; see Chapter 4.
<b>Forced-flow leaching</b>	Solid material is packed into stainless steel column and toluene (or other extraction solvent) is pumped into the column under pressure and with heating; hot solvent leaches (extracts) out extractable compounds which are collected at the exit of the column; see Chapter 14.
<b>Fraction of analyte extraction</b>	The expression is the fraction of analyte extracted (E): $E = C_o V_o / (C_o V_o + C_{aq} V_{aq}) = K_D V / (1 + K_D V)$ where $V_o$ is the volume of organic phase, $V_{aq}$ the volume of aqueous phase, and $V$ is the phase ratio $V_o / V_{aq}$ ; see Chapter 7.
<b>Fractionation range</b>	In SEC, refers to the operating range of a gel or packing. This is the range in which the packing can separate molecules based on their size. At one end of the range, molecules that are too large to diffuse into the pores are excluded. At the other end of the range, molecules that can diffuse into all of the pores totally permeate the packing eluting (unseparated) at the permeation volume; see Chapter 11.
<b>Freeze drying</b>	The process of removing water, mainly from biological samples, by using vacuum sublimation; see Chapter 4.
<b>Frit</b>	The porous element at either end of a column that serves to contain the column or SPE packing. It is placed at the very ends of the column tube or more commonly in the end fitting. Frits can be stainless steel or other inert metal or plastic, such as porous PTFE or polypropylene. The frit porosity must be less than the smallest particle in the HPLC column, otherwise particles will pass through the frit and packing will be lost.
<b>Gas-phase extraction</b>	See <i>direct thermal sampling</i> .
<b>Gel</b>	The solid packing used in gel chromatography or GPC. An actual gel really consists of two parts: the dispersed medium (solid portion) and the dispersing medium (the solvent). Also defined as a colloidal dispersion of a solid and liquid in which the solid is the continuous phase.
<b>Gel filtration chromatography</b>	Also called aqueous size exclusion chromatography; carried out with aqueous mobile phases. Generally refers to molecular size separations performance on soft gels such as polydextrans but highly cross-linked polymers, silica gels, and other porous media may also be used. Most gel filtration separations involve biopolymers and water-soluble polymers, such as polyacrylic acid; see Chapter 11.
<b>Gel permeation chromatography</b>	SEC carried out with organic mobile phases used for the separation and characterization of polymers. SEC with aqueous mobile phases is referred to as aqueous GPC or GFC; see Chapter 11.
<b>Grab sampling</b>	In gas sampling, an evacuated sample canister can be opened and sample rapidly collected at an uncontrolled rate, usually over several seconds, until the container reaches equilibrium with atmospheric pressure. Generally, this qualitative approach is used when unknown analytes must be identified, when the air contains high concentrations of analytes at certain (short) times, or when an odor is noticed and a sample must be obtained quickly. Paired grab samples (before/after or smell/no smell) often are employed to qualitatively diagnose a perceived problem; see Chapter 2.



<b>Graphitized carbon</b>	A graphitic carbon with more or less perfect three-dimensional hexagonal crystalline order prepared from non-graphitic carbon by graphitization heat treatment; this packing material has a strong affinity for polar compounds in aqueous samples and water miscible organic extracts. Commonly used in sample prep for pesticide analysis for removal of pigment in food samples; also known as graphitized carbon black (GCB); see Chapters 8 and 9.
<b>Grinding</b>	Both manual and automated mortar and pestles are available; grinding can be performed under wet or dry conditions; by this process particles of approx. 10 $\mu\text{m}$ can be achieved; see Chapter 4.
<b>Headspace sampling</b>	Headspace (HS) refers to the vapors that form above liquids and solids; if the sample is in thermodynamic equilibrium with the gas phase in a closed thermostatted vessel, the method is called static HS; if an inert gas passes over or through the sample and stripped sample volatiles accumulate in an adsorbent or cryogenic trap, the method is called dynamic HS or purge and trap sampling; see Chapters 2 and 6.
<b>Headspace single drop microextraction</b>	A single drop of solvent (a microliter or two) suspended in the headspace can partition volatile analytes into the solvent; the drop can be withdrawn into the syringe and injected into a GC; see Chapters 6 and 7.
<b>Headspace solid phase microextraction</b>	Instead of a drop of solvent, a polymer-coated fiber can be placed in the headspace; once the analytes adsorb on the polymer coat, the fiber can be transferred to a GC inlet and the sorbed analytes volatilized by thermal desorption; see Chapters 6 and 7.
<b>Heart cutting</b>	In preparative LC, refers to collection of the center of the peak where purity should be maximum. The term is also used in <i>column switching</i> ; see Chapter 13.
<b>High-abundance protein depletion</b>	Using antibody columns specific for the highest abundance proteins, they can be selectively removed from plasma allowing the biochemist to investigate the lower abundance proteins which may be biomarkers or other compounds of interest; see Chapter 15.
<b>HILIC</b>	Hydrophilic interaction liquid chromatography; a technique using polar stationary phases such as silica, amino, diol, etc. and polar mobile phases such as water and acetonitrile, at least 2.5% water is needed in mobile phase; mechanism is thought to involve analyte partitioning into sorbed water layer; high concentrations of acetonitrile or other water-miscible solvent are used; opposite of reversed-phase (RPC) LC, water is a strong solvent and a gradient increases its concentration with time; technique is best for small polar analytes that are weakly retained on RPC columns; see Chapter 9.
<b>Hollow fiber liquid phase microextraction (HF-LPME)</b>	A hollow fiber (HF) membrane technique in which an HF membrane separates two extraction phases; the membrane serves as a barrier and can be impregnated with solvent to permit liquid-liquid or liquid-liquid-liquid extractions to take place; the membrane can be selected to allow certain analytes to pass through but not others; see Chapters 7 and 18.

<b>Homogenization</b>	The process of making a sample more uniform by size reduction and blending; homogenizers with high speed blades are available to do the job; see Chapter 4.
<b>Hydrophilic (hydrophylic)</b>	"Water loving;" refers both to stationary phases that are fully compatible with water or to water-soluble molecules in general. Many columns used to separate proteins (ion exchange, SEC, affinity) are hydrophilic in nature and should not irreversibly sorb or denature protein in the aqueous environment.
<b>Hydrophobic</b>	"Water hating;" refers both to stationary phases that are not compatible with water and to molecules in general that have little affinity for water. Hydrophobic molecules have few polar functional groups; most have a high content of hydrocarbon (aliphatic and aromatic) functionality.
<b>ICAT</b>	Isotope-coded affinity tag; a gel-free method for quantitative proteomics that relies on chemical labeling reagents. These chemical probes consist of three general elements: a reactive group capable of labeling a defined amino acid side chain (e.g., iodoacetamide to modify cysteine residues), an isotopically coded linker, and a tag (e.g., biotin) for the affinity isolation of labeled proteins/peptides. For the quantitative comparison of two proteomes, one sample is labeled with the isotopically light (d0) probe and the other with the isotopically heavy (d8) version. To minimize error, both samples are then combined, digested with a protease (i.e., trypsin), and subjected to avidin affinity chromatography to isolate peptides labeled with isotope-coded tagging reagents. These peptides are then analyzed by liquid chromatography-mass spectrometry (LC-MS). The ratios of signal intensities of differentially mass-tagged peptide pairs are quantified to determine the relative levels of proteins in the two samples. The original tags were developed using deuterium, but later the same group redesigned the tags using <sup>13</sup> C instead to circumvent issues of peak separation during LC due to the deuterium interacting with the stationary phase of the column; see Chapter 15.
<b>Immobilized liquid extraction</b>	Similar to SPE, but a polymeric stationary phase is bonded to the inside of glass vial; experiment performed within the glass vial; analytes partition into polymeric phase and loading, washing, and elution steps are performed by addition of various solvents.
<b>Immunoaffinity SPE</b>	Phases based on molecular recognition using chemically attached mono- or poly-clonal antibodies; due to antibody-antigen interactions, these phases are some of the most selective phases available; immunoaffinity phases are commercially available for small molecules such as pollutants, toxins, etc.; an example of such a phase for large biomolecules; see <i>high abundance protein depletion</i> ; see Chapter 10.
<b>Immunosorbent</b>	See <i>immunoaffinity SPE</i> .
<b>Impinger</b>	Glass bubble tube designed for the collection of airborne hazards into a liquid medium. When using a personal air sampler, a known volume of air bubbles is pumped through the glass tube that contains a liquid specified in the method. The liquid is then analyzed to determine airborne concentrations. An impinger may be mounted on the side of an air sample pump or put into a holster and placed near a worker's breathing zone; see Chapter 6.

<b>Imprinted phases</b>	Polymer and silica phases generated in the presence of a "template" or "printing" molecule. Such phases have enhanced selectivity for the templating molecule; also called molecularly imprinted phases (MIPs); see Chapter 10.
<b>In situ derivatization (SPE)</b>	The act of derivatizing a compound of interest in its native environment; for example, for a tenaciously held analyte on a soil sample changing its chemical nature by performing an in situ derivatization, the compound may be more easily released and isolated for further workup or analysis; derivatization may also be formed in solution and the derivatized compound extracted by LLE; see Chapters 9 and 20.
<b>Internal standard</b>	In quantitative analysis, precision and accuracy are greatly improved by use of internal standards (ISs). The procedure involves the addition of a fixed amount of internal standard (IS) to a series of increasing concentrations of reference sample and to the unknown concentration. The ratio of the areas of the reference concentrations and the areas of the IS is plotted against the known concentration of the reference samples. The internal standard should be chemically similar to the substance being quantitatively determined and should have a retention time fairly close to it.
<b>Ion exchange capacity</b>	The number of ionic sites on the packing that can take place in the exchange process. The exchange capacity is expressed in milliequivalents per gram. A typical styrene-divinylbenzene strong anion exchange resin may have 3-5 meq/gm capacity. Exchangers for IC have very low capacity. Capacity of weak anion and cation exchangers varies dramatically with pH.
<b>Ion exchange chromatography</b>	A mode of chromatography in which ionic substances are separated on cationic or anionic sites of the packing. The sample ion (and usually a counterion) will exchange with ions already on the ionogenic group of the packing. Retention is based on the affinity of different ions for the site and a number of other solution parameters (pH, ionic strength, counterion type, etc.) Ion chromatography is basically an ion exchange technique.
<b>Ionic strength</b>	A characteristic of an electrolyte solution. It is typically expressed as the average electrostatic interactions among an electrolyte's ions. It is related to electrolyte concentration but the main difference between ionic strength and electrolyte concentration is that the former is higher if some of the ions are more highly charged. The higher the ionic strength of a mobile phase the more the mobile phase competes with the analyte for ionic or adsorptive sites.
<b>Ion pair chromatography</b>	Form of chromatography in which ions in solution can be "paired" or neutralized and separated as an ion pair on a reversed-phase column. Ion pairing agents are usually ionic compounds that contain a hydrocarbon chain which imparts a certain hydrophobicity so that the ion pair can be retained on a reversed-phase column. Retention is proportional to the length of the hydrophobic chain and the concentration of the ion pair additive. Ion pairing can also occur in normal phase chromatography when one part of the pair is dynamically loaded onto a sorbent, but this technique is not as popular as the RPC technique. Also known as ion-interaction (IIR) chromatography or dynamic ion exchange chromatography stressing the fact that the precise mechanistic details of how the additive controls retention are not always known.

<b>Irregular packing</b>	Refers to the shape of a column packing. These irregular packings are available in microparticulate sizes. The packings are obtained from grinding solid materials into small particles and then sizing them into narrow fractions using classification machinery. Spherical packings are now used more than irregular packings in analytical HPLC but the less expensive, irregular packings are still widely used in prep LC and SPE; see Chapter 9.
<b>Isolate</b>	Analyte to be isolated from matrix background and then analyzed; see analyte.
<b>Kieselguhr</b>	A diatomaceous earth used both in column chromatography and as a sample cleanup media. Only weakly adsorptive, it is also used as a support in liquid-liquid chromatography and in supported liquid extraction; see supported liquid extraction. Rarely used in HPLC; see diatomaceous earth and Chapters 2, 7 and 14.
<b>Langmuir adsorption isotherm</b>	A specific form of an isotherm $C_S = N_0 * C_M / (K_d + C_M)$ where $C_S$ and $C_M$ are the equilibrium stationary and mobile phase concentrations of the solute, $N_0$ the total number of surface sites available for sorption and $K_d$ the sorption binding constant.
<b>Large volume injection (LVI)</b>	A technique for introduction of larger than normal volumes of sample in a solvent into a capillary GC column; in this approach, the bulk of the solvent is evaporated before the sample transfers to the analytical column; there are two popular LVI techniques: programmed temperature vaporization and cool on-column injection with solvent vapor exit; both are approaches to lowering detection limits; see Chapter 6.
<b>Ligand</b>	In ligand exchange chromatography, refers to the analyte which undergoes ligand exchange with the stationary phase; in affinity chromatography, refers to the biospecific material (enzyme, antigen, or hormone) coupled to the support (carrier) to form the affinity column; in bonded phase chromatography, this denotes the moiety covalently bound to the surface.
<b>Limit of detection (LOD)</b>	The concentration of the analyte at which the resulting peak can be distinguished from baseline noise. Literature and norms describe different ways of determination of the LOD.
<b>Limit of quantitation (LOQ)</b>	The minimum concentration of the analyte at which the resulting peak can be quantified with a defined security level. Typically 3 to 5 times higher than LOD.
<b>Liquid-liquid extraction (LLE)</b>	An extraction technique for separating interferences from the analyte(s) by partitioning the analytes between two immiscible liquids (or phases); one phase is usually aqueous and the second phase an organic solvent; more hydrophilic compounds prefer the aqueous phase while more hydrophobic compounds will be found in the organic solvent; by the use of additives (e.g. buffers, ion pair reagents, etc.) equilibria can be shifted to "force" analytes or matrix compounds into one or other of the two layers; see Chapter 7.

<b>Liquid phase microextraction</b>	A liquid extraction technique when there is a great reduction in the acceptor-to-donor phase ratio; a hollow fiber is impregnated with an organic solvent used to accommodate or protect microvolumes of acceptor solution. This novel methodology proves to be an extremely simple, low-cost, and virtually solvent-free sample-preparation technique, which provides a high degree of selectivity and enrichment by additionally eliminating the possibility of carry-over between runs; see Chapters 6, 7 and 18.
<b>Liquid-solid extraction</b>	The general expression for extraction techniques that uses an organic solvent to extract analytes from a solid material. In its simplest form, the "shake flask" extraction takes place at room temperature and works well in cases when the matrix is porous and the analyte(s) are easily extractable; see Chapters 2 and 14.
<b>Loading step (SPE)</b>	The second step in SPE (after conditioning) when the sample is loaded onto the SPE phase (cartridge); see Chapter 9.
<b>Lyophilization</b>	The process of dehydrating a sample, often biological, containing water by using vacuum sublimation; also referred to as freeze drying; see Chapter 4.
<b>Maceration</b>	The process of breaking down a soft material into smaller parts by tearing, chopping, cutting, etc; see Chapter 4.
<b>Macroporous resin (macroreticular)</b>	Crosslinked ion exchange resins that have both micropores of molecular dimensions but also macropores of several hundred Angstroms wide. These are highly porous resins with large internal surface area accessible to large molecules.
<b>Magnetic bead technology</b>	Micro magnetic beads are uniform polymer particles, typically 0.5-500 micrometres in diameter, that have iron oxide particles (or other particles that may be attracted to magnets) contained within the polymer matrix. Bio-reactive molecules can be adsorbed or coupled to their surface, and used to separate biological materials such as cells, proteins, or nucleic acids; by the use of magnets/magnetic fields, the beads can be easily manipulated in test tubes or 96-well plates. These microbeads are used for isolation and handling of specific material or molecules, as well as for analyzing sensitive molecules, or those that are in low abundance, e.g. in miniaturized and automated settings.
<b>Matrix</b>	In sample prep, matrix normally refers to the substance in which the analyst is attempting to measure a solute or series of solutes; often the matrix is of no interest and its concentration must be reduced or eliminated in order for a separation and measurement to take place; the matrix can be organic, inorganic or biological.
<b>Matrix adsorption mode (SPE)</b>	A lesser used mode of SPE in which the sorbent is chosen to maximize retention of the matrix and other interferences while the analyte of interest is unretained; the opposite of the normal process (bind-elute) of SPE, there is no concentration of the analytes; see Chapter 9.

<b>Matrix solid phase dispersion</b>	Technique uses bonded phase solid supports as abrasives to produce disruption of sample architecture and as a bound solvent to aid complete sample disruption during the sample blending process; the finely divided sample is gently blended with a mortar and pestle and transferred to a column and analytes eluted with appropriate solvents; see Chapter 10.
<b>Matrix solid phase extraction</b>	See <i>matrix solid phase dispersion</i> .
<b>Membrane filtration</b>	Membrane filter; membrane disk.
<b>Method development</b>	A process of optimizing the separation including the sample pre-treatment so as to obtain a reproducible and robust separation. It usually emphasizes the search for the stationary phase, eluent and column temperature which provides an adequate separation or sample enrichment.
<b>Method validation</b>	A process of testing a method to show that it performs to the desired limits of precision and accuracy in retention, resolution and quantitation of the sample components of interest.
<b>Microdialysis</b>	A minimally-invasive sampling technique that is used for continuous measurement of free, unbound analyte concentrations in the extracellular fluid of virtually any tissue. Analytes may include endogenous molecules (e.g. neurotransmitter, hormones, glucose, etc.) to assess their biochemical functions in the body, or exogenous compounds (e.g. pharmaceuticals) to determine their distribution within the body. The microdialysis technique requires the insertion of a small microdialysis catheter (also referred to as microdialysis probe) into the tissue of interest. Once inserted into the tissue or (body) fluid of interest, small solutes can cross the semi-permeable membrane by passive diffusion. The microdialysis probe is designed to mimic a blood capillary and consists of a shaft with a semi-permeable hollow fiber membrane at its tip, which is connected to inlet and outlet tubing; see Chapters 15 and 18.
<b>Microextraction</b>	The general process of liquid extraction using small amounts of organic solvent where the phase ratio $V_o/V_{aq}$ is quite low; other techniques using hollow microfibers as a barrier is also referred to as microextraction; see Chapters 7 and 18.
<b>Micropipette tip</b>	See <i>pipette tip</i> .
<b>Micropipette tip (SPE)</b>	A form of SPE in which the packing material is embedded or adsorbed on the inner walls of a pipette tip; useful for the SPE of very small amounts of liquid sample; often used with x-y-z liquid handling systems for automation purposes; see Chapter 9.
<b>Microporous resin</b>	See <i>microreticular resin</i> .

<b>Microreticular resin</b>	Crosslinked synthetic ion exchange resins which have pores with openings corresponding to molecular sizes. Diffusion into the narrow pores can be impaired and low exchange rates can occur as well as poor performance, especially for large molecules.
<b>Microwave-assisted extraction (MAE)</b>	The use of microwave energy to heat samples in the presence of a solvent allowing for rapid extraction; MAE can be performed in open vessels where a non-microwave absorbing solvent is used and the sample containing a substance with a high dielectric constant (e.g. water) is rapidly heated with the extracted analytes passing into the extraction solvent. A variation of this is the addition of an inert microwave absorbing solid substance that transfers the heated energy to the surrounding solvent. MAE can also take place in closed vessels which are non-microwave absorbing containers; in these cases, microwave absorbing is used and the temperature and pressure inside the vessel rises to assist in the rapid extraction of analytes; see Chapter 14.
<b>Milling</b>	Devices for reducing particle sizes of solid materials. Disk mills pulverize <20 mm diameter hard samples by feeding between stationary and rotating disks with adjustable gap settings; samples are generally reduced to 100 µm diameter; rotor speed mills combine impact and shearing processes to grind soft-to-medium hard and fibrous materials to 80 µm; ball mills grind material to sub-micron size by developing high-grinding energy via centrifugal or planetary actions using agate, tungsten carbide or PTFE-coated stainless steel balls; see Chapter 4.
<b>Mincing</b>	The process of breaking down a meat or vegetable product into smaller parts by tearing, chopping, cutting, dicing, etc; see Chapter 4.
<b>Mixed bed column</b>	Combination of two or more stationary phases in the same column used most often in ion exchange separations (IEC) (mixed anion and cation resins) and SEC (mixture of different pore size packings). Advantage in IEC is the total removal of both cationic and anionic compounds; useful in SEC because a wider molecular weight range can be accommodated by the same column.
<b>Mixed mode separation</b>	A separation that takes place in a single column due to retention and selectivity provided by a dual retention mechanism. For example, at intermediate-to-high pH values, a reversed-phase column with residual silanols can separate by hydrophobic interactions as well as ionic interactions by virtue of the ionized silanols; sometimes mixed mode separations can be quite beneficial to the selectivity (band spacing) but can cause peak asymmetry and the precise balance of interactions may be difficult to reproduce with subsequent batches of packing. Also useful in SPE.
<b>Modifier</b>	An additive that changes the character of the mobile phase. For example, in reversed-phase, water is the weak solvent and methanol, the strong solvent, is sometimes called the modifier; sometimes other additives such as competing bases (triethylamine or ion pair reagents) are referred to as modifiers, but they should more correctly be called additives; see <i>additives</i> .
<b>Molecularly imprinted polymers (MIPs)</b>	See <i>imprinted phases</i> .

**Multidimensional chromatography**

The use of two or more columns or chromatographic techniques to effect a better separation. It is useful for sample cleanup, increased resolution, and increased throughput. It can be used off-line by collecting fractions and reinjecting onto a second column or on-line by the use of a switching valve. Also called coupled column chromatography, column switching, multi-column chromatography, or box car chromatography; see Chapter 13.

**Multimodal SPE**

The practice of SPE when two different phases or modes are used to clean up a sample; the process can refer to two separate cartridges placed in series and analytes separated on the two different cartridges; a second process can be used when two different phases are present in the same cartridge or even on the same packing; sometimes referred to as mixed-mode SPE; see Chapter 10.

**Non-polar**

A non-polar molecule is one that the electrons are distributed more symmetrically and thus does not have an abundance of charges at the opposite sides. The charges all cancel out each other. Non-polar compounds, solvents or bonded phases readily dissolve in organic solvents, such as hexane, or prefer such solvents in place of water. Non-polar substances do not readily dissolve in water.

**Octadecylsilane (ODS)**

The most popular reversed-phase in HPLC and SPE. Octadecylsilane phases are bonded to silica or polymeric packings. Both monomeric and polymeric phases are available.

**Octylsilane**

A popular stationary phase in reversed-phase chromatography; usually has slightly less retention than the more popular C18; both monomeric and polymeric phases available.

**Off-line SPE**

The normal practice of SPE in which SPE cartridges, disks, pipette tips, etc. are handled using manual processes (i.e. vacuum manifolds, pipette transfer, etc.); opposite of on-line SPE.

**On-column injection**

In GC, refers to the process of injecting the entire liquid sample directly onto the head of the column using a fine needle that fits inside the capillary; see Chapter 6.

**On-line column switching**

See on-line SPE for operating principle; in column switching the second column is usually another HPLC or GC column, rather than a short SPE column; the main purpose of column switching is to resolve more complex mixtures than can be handled by a single chromatographic column; in GC, the use of Deans switching when differential pressure is used to control the relative flow of gas through the two columns; in LC, switching valves are most frequently used; see Chapter 13.



<b>On-line preconcentration</b>	A precolumn is placed in front of the separation column to concentrate analytes prior to their separation; different mechanisms may be used (e.g. hydrophobic interaction, adsorption, enzymatic reaction) to retain analyte as a function of time and then by a displacement process (e.g. solvent elution, pH change, etc.), concentrated analyte(s) are transferred to the separation column.
<b>On-line SPE</b>	Refers to the use of small cartridges packed with SPE packings placed across two ports of a 6- or 10-port injection or column switching valve; the SPE trap is loaded with sample by an external pump or syringe transfer and then the valve is switched so that the SPE trap becomes part of the HPLC flow stream and analytes can be swept into the column based on the solvent being used for displacement; on-line SPE columns are usually used multiple times while off-line SPE cartridges are generally used once; see Chapter 13.
<b>Packing</b>	The adsorbent, gel, or solid support used in the HPLC or SPE column. Most modern analytical HPLC packings are less than 10 $\mu\text{m}$ in average diameter with 5 $\mu\text{m}$ currently being the favorite. SPE particles are much larger (>20 micron).
<b>Paper filtration</b>	Using porous filter paper (mainly cellulose) to remove particulates from liquid samples; papers with different porosities are available. Low porosity filters will remove very fine particulates but may have a lower flow rate while high porosity filters filter out larger particulates at a higher flow rate; paper filtration is often used in wet chemistry to filter, combust, and then weigh insoluble materials; ashless filter paper is also used for this purpose; see Chapter 5.
<b>Particle size reduction</b>	The general process of reducing larger particles down to a size that can be more conveniently extracted; the smaller the particle, the more quickly it will dissolve, or if insoluble the more quickly analytes can be extracted for further sample cleanup. Typical methods for reducing particle size include pulverizing, milling, homogenizing, chopping, blending, and so on; see Chapter 4.
<b>Particulates</b>	Generally refers to small particles found in the mobile phase that can cause backpressure problems by lodging in frits; can also refer to the small particles packed into HPLC columns.
<b>Passive sampling</b>	In passive gas sampling, an air sample is pulled through a flow controller into an evacuated canister over a chosen period of time, ranging from 5 minutes to 24 hours. The sampling period and the flow rate determine the canister volume required.
<b>Peak tracking</b>	A way of matching peaks that contain the same compound between different experimental runs during method development; relies upon detection parameters of each pure analyte; diode array detectors and mass spectrometers are among the best detectors for peak tracking due to their specificity.

<b>Phenol extraction</b>	A sample preparation technique used for the isolation of DNA from biological samples; see Chapter 15.
<b>Pipette tip</b>	Replaceable tips used in automation of liquid handling chores; used once and discarded to avoid contamination.
<b>pK<sub>a</sub></b>	An acid dissociation constant, K <sub>a</sub> , (also known as acidity constant, or acid-ionization constant) is a quantitative measure of the strength of an acid in solution. It is the equilibrium constant for a chemical reaction known as dissociation in the context of acid-base reactions. The equilibrium can be written symbolically as: HA $\rightleftharpoons$ H <sup>+</sup> + A <sup>-</sup> where HA is a generic acid that dissociates by splitting into A <sup>-</sup> , known as the conjugate base of the acid, and the hydrogen ion or proton, H <sup>+</sup> , which, in the case of aqueous solutions, exists as the hydronium ion – in other words, a solvated proton; The dissociation constant is usually written as a quotient of the equilibrium concentrations (in mol/L), denoted by [HA], [A <sup>-</sup> ] and [H <sup>+</sup> ]: K <sub>a</sub> = ([H <sup>+</sup> ] [A <sup>-</sup> ]) / [HA]; due to the many orders of magnitude spanned by K <sub>a</sub> values, a logarithmic measure of the acid dissociation constant is more commonly used in practice. The logarithmic constant, pK <sub>a</sub> , which is equal to $-\log_{10} K_a$ , is sometimes also (but incorrectly) referred to as an acid dissociation constant.
<b>Polar</b>	A molecule may be polar as a result of polar bonds or as a result of an asymmetric arrangement of non-polar bonds and non-bonding pairs of electrons; Polar molecules are generally able to dissolve in water (H <sub>2</sub> O) due to the polar nature of water; polar molecules do not prefer non-polar organic solvents such as hexane. Polar molecules have slightly positive and slightly negatively charged ends; oftentimes we refer to a compound's polarity.
<b>Polarity index (P')</b>	A measure of the relative polarity of a solvent and is useful for identifying suitable mobile phase or extraction solvents. The polarity index increases with polarity; examples: hexane P' = 0.0; isopropanol P' = 3.9; THF P' = 4.0; methanol P' = 5.1; acetonitrile P' = 5.8; water P' = 9.0.
<b>Polymeric packings</b>	Packings based on polymeric materials, usually in the form of spherical beads. Typical polymers used in LC and SPE are polystyrene-divinyl-benzene (PS-DVB), polydivinylbenzene, polyacrylamide, polymethylacrylate, polyethyleneoxide, polydextran, or polysaccharide.
<b>Polymeric SPE</b>	The use of a polymeric base material (e.g. PS-DVB, methacrylate) rather than an inorganic material (e.g. silica, alumina); polymers generally have a wider pH range and higher sample capacity than some of the inorganic materials; see Chapter 9.
<b>Polystyrene-divinylbenzene resin</b>	The most common base polymer for ion exchange chromatography. Ionic groups are incorporated by various chemical reactions. Neutral PS-DVB beads are used in RPC. Porosity and mechanical stability can be altered by variation of the crosslinking through the variation of the DVB content.
<b>Pore size</b>	The average size of a pore in a porous packing. Its value is expressed in Å or in nm. The pore size determines whether a molecule can diffuse into and out of the packing; see <i>mean pore diameter</i> .
<b>Post-column derivatization</b>	See <i>post-column reaction</i> ; see Chapter 20.

<b>Precolumn derivatization</b>	See precolumn reaction; see Chapter 20.
<b>Prefilter (SPE)</b>	In some cases when samples contain a large amount of particulates, regular SPE cartridges and disks may become clogged and flow is reduced; prefilters are filter devices that have higher porosity that will filter out large particles and allow the SPE bed to operate more efficiently; some SPE devices have prefilters built in, others one can add a prefilter; in some cases, the use of an inert packing such as glass beads serve the same purpose as an actual filter; see Chapter 9.
<b>Pressing</b>	The general process of squeezing liquid from a semi-solid material (e.g. plants, fruit, meat); see Chapter 4.
<b>Pressurized fluid extraction</b>	See accelerated solvent extraction; see Chapter 14.
<b>Pressurized solvent extraction</b>	See accelerated solvent extraction; see Chapter 14.
<b>Primary sampling</b>	The collection of one or more increments or units initially taken from a population; the primary sample is that taken from the primary source; proper statistical sampling protocols are recommended; see Chapter 4.
<b>Programmed temperature vaporization (PTV)</b>	Sample introduction technique in which sample is introduced into the inlet liner at a temperature slightly below the boiling point of the solvent; the solvent is continually evaporated and vented through the inlet split line; once the solvent is gone, the temperature of the inlet is heated very rapidly to transfer the sample into the column; using PTV, there is less sample discrimination and less thermal degradation of sensitive compounds compared to hot inlet injections; see Chapter 6.
<b>Protein crashing</b>	Term used in removing/reducing the protein concentration in a biological fluid such as plasma; after slight dilution, an organic solvent such as acetonitrile is added to the plasma and the proteins being insoluble are precipitated (crashed). By the use of centrifugation or filtration, the protein is removed and the supernatant liquid used for injection into an HPLC or worked up further; see Chapter 16.
<b>Protein precipitation</b>	See <i>protein crashing</i> .
<b>Pulsed splitless injection</b>	A form of GC injection recommended for large volumes (up to 5 $\mu$ L) of sample in which a short-term high pressure pulse is imposed on the inlet such that there is not a large volume of solvent vapor generated and most or all of the sample is directed to the column; once the sample is transferred, then normal pressure is resumed; using this technique, highly volatile compounds cannot be lost through the split vent line and thermally unstable compounds spend less time in the hot injection port so there is less degradation; see Chapter 6.

<b>Pulverizing</b>	Electromechanically driven rod or vibrating base devised to reduce particle size of solid samples; a freezer mill can be used with liquid nitrogen to treat malleable polymers or those with low glass transition temperatures; see Chapter 4.
<b>Purge and trap sampling</b>	Dynamic headspace technique in which the headspace vapors over a liquid or solid sample are continuously removed by flow of gas over the sample (purging); volatilized analytes are usually concentrated by trapping on an adsorbent or by cryogenic means. Most often used for volatile trace analytes when concentration is needed; see Chapters 2 and 6.
<b>Pyrolysis</b>	The process of heating a sample hot enough to break its chemical bonds, thereby forming smaller molecules that can be analyzed by GC; see Chapter 6.
<b>Quaternary methyl amine</b>	A strong anion exchange functionality popular in resin-based packings; usually supplied in chloride form.
<b>QuEChERS</b>	A technique initially used for the extraction of pesticides from fruits and vegetables. It consists of two steps: 1) Salting out extraction using buffered or unbuffered solvent (usually acetonitrile), and 2) Dispersive SPE in which solid adsorbent is used to treat an aliquot from step 1 to remove interferences and matrix compounds. QuEChERS is mostly used with GC/MS and LC/MS (or MS-MS) to more selectively analyze the pesticide extracts; more recently, QuEChERS has expanded to other matrices such as cooking oil, meat, fish, biological fluids, etc., and to other analytes (e.g. pharmaceuticals, antioxidants, toxins, etc.); see Chapter 8.
<b>Removable well plates</b>	See <i>array 96-well plate</i> ; see Chapter 9.
<b>Representative sample</b>	A sample resulting from a statistically worked out sampling plan; it can be expected to adequately reflect the properties of interest of the parent population.
<b>Residual silanols</b>	The silanol (-Si-OH) groups that remain on the surface of a packing after chemically bonding a phase onto its surface. These silanol groups that may be present in very small pores may not be accessible to the reacting bulky organosilane (e.g., octadecyldimethylchlorosilane), but may be accessible to small polar compounds. Often, they are removed by endcapping with a small organosilane such as trimethylchlorosilane. See <i>endcapping</i> .
<b>Resin</b>	A solid polymeric packing used in ion exchange separations. The most popular resins are polystyrene-divinylbenzene co-polymers of small particle size (<10 μm). Ionic functionality is incorporated into the resin.
<b>Restricted access media (RAM)</b>	Sorbents used for the direct injection of biological fluids, such as plasma or serum, into an HPLC flow stream; they contain an outer hydrophilic surface that provides minimal interaction with proteins and when combined with small pores on the sorbent exclude them; the inner surface is hydrophobic and when small molecules diffuse into the pores, they interact by reversed-phase mechanisms and are retained; the small molecules, such as drugs and their metabolites, can be removed by rinsing with an organic solvent; RAMs are most successfully used in a column switching setup in which the secondary column is used to resolve the small molecules and the proteins are directed to waste so as not to foul the secondary column; see Chapter 10.

<b>Riffler</b>	A manual or automated mechanical device used in sub-dividing solid powder samples into smaller units; sub-division is achieved when material samples are cut into two smaller portions by a single pass; further sub-divisions can be attained by multiple passes; see Chapter 4.
<b>Rinse step (SPE)</b>	Also known as the <i>wash step</i> , the third step in the SPE process; once the sample is loaded, the rinse step is designed to eliminate interferences including various matrix compounds; here, a solvent(s) or buffer is selected to remove interferences, but not the analytes of interest; see Chapter 9.
<b>Round well plates</b>	96-well plates that have round-shaped wells resembling 96 small test tubes; see <i>96-well plates</i> .
<b>Salting out effect</b>	The use of a high concentration of salt buffer in the mobile phase to cause a low polarity analyte to have a decreased solubility in water and therefore precipitate or come out of solution; most often used for the hydrophobic interaction chromatography of proteins when proteins are first precipitated at high salt concentrations then eluted by gradual dilution using reverse gradient elution; can also be used in liquid-liquid extraction; see salting out extraction; see Chapter 8.
<b>Salting out extraction</b>	See QuEChERS or salting out effect; in this extraction approach, high concentrations of salt in the aqueous phase will cause certain compounds to migrate into an organic phase or perhaps vice-versa; high concentrations of salt will also force normally miscible solvents (e.g. water and acetonitrile) to become immiscible and be used for further partitioning more polar analytes than could be achieved by an extraction using a non-polar organic solvent; see Chapter 8.
<b>Sample division</b>	The process in sample reduction to divide the sample into smaller portions while retaining the representative character of the primary sample; see Chapter 4.
<b>Sample pre-treatment</b>	Often synonymous with sample preparation; the process of manipulating the sample to make it easier to analyze later.
<b>Sample size reduction</b>	The process in sample reduction to divide the sample into smaller portions while retaining the representative character of the primary sample; see Chapter 4.
<b>Sample tracking</b>	The process of tracking primary, secondary, laboratory, and further samples through the analytical cycle; it is important for chain or custody reasons to be able to ensure that the sample finally analyzed in the instrument was from the original sample collected at the source; sample tracking can be as simple as writing a sample number on a container to have bar coded vials or RFI tags to automatically keep track of sample flow.
<b>Sampling</b>	The process of collecting a representative sample at the source; sampling can also refer to further sample division as it more closely approaches the laboratory analysis; it is important to make sure that the final sample analyzed represents a sub-sample of the original sample without any imposed bias or discrimination.

<b>Sampling error</b>	Incurred when the statistical characteristics of a population are estimated from a subset or sample of that population. Since the sample does not include all members of the population, statistics on the sample, such as means and quantiles, generally differ from parameters on the entire population. Since sampling is typically done to determine the characteristics of a whole population, the difference between the sample and population values is considered a sampling error. Exact measurement of sampling error is generally not feasible since the true population values are unknown; however, sampling error can often be estimated by probabilistic modeling of the sample; see Chapter 4.
<b>Scavenger</b>	Special type of solid phase particle that, instead of molecular interactions that occur in SPE, uses chemical reactions to remove undesired species, such as undesired reaction products or excess starting material from an organic synthesis; mostly operate on the basis of covalent bonding; packing materials contain reactive groups that can be used for organic or inorganic species such as catalysts; see Chapter 9.
<b>Secondary sampling</b>	Refers to the process of taking a representative portion of the primary sample in order to further reduce its particle size, or to prepare a laboratory sample for eventual analysis; see Chapter 4.
<b>Sieving</b>	Process of passing a sample of solid particles through a metal or plastic mesh of a uniform cross-sectional area (square opening from 3 $\mu\text{m}$ -123 mm) to separate particles into uniform sizes; can be performed under wet and dry conditions; see Chapter 4.
<b>Silanol</b>	The Si-OH group found on the surface of silica gel. There are different strengths of silanols depending on their location and relationship to each other and based on the metal content of the silica. The strongest silanols are acidic and often lead to undesirable interactions with basic compounds during chromatography.
<b>Silanophile</b>	A compound which has high affinity for active (acidic) silanol groups on the surface of silicas. Usually a strongly basic amine.
<b>Silica gel</b>	The most widely used HPLC packing. It has an amorphous structure, is porous, and consists of siloxane and silanol groups. It is used in all modes of LC as a bare packing for adsorption, as the support for LLC, or for chemically bonded phases, and, with various pore sizes, as an SEC packing. Microparticulate silicas of 3, 5, and 10 $\mu\text{m}$ average particle diameter are used in HPLC. Compared to irregular silicas, in modern analytical HPLC columns, spherical silicas are preferred due to their packing reproducibility and because they have lower pressure drops; sometimes referred to as silica.
<b>Single drop microextraction</b>	One drop of solvent (a microliter or two) suspended in the headspace can partition volatile analytes into the solvent; the drop can be withdrawn into the syringe and injected into a GC; see Chapter 7.

<b>Solid phase extraction (SPE)</b>	A widely used technique for sample preparation using a solid phase packing (dp of 20-40 $\mu\text{m}$ ) contained in a small plastic cartridge, disk, or well of a 96-well flow-through plate. The solid stationary phases used are no different than HPLC packings. However, although related to chromatography, the principle is different and is sometimes referred to as digital chromatography. The process as most often practiced requires four steps: 1) Conditioning the sorbent, 2) Adding the sample, 3) Washing away the impurities, and 4) Eluting the sample in the smallest volume possible with a strong solvent; Can be performed in a variety of formats: cartridges, disks, pipette tips, 96-well plates, etc., and in a variety of modes, such as reversed-phase, ion exchange, normal phase, etc.; see Chapters 9 and 10.
<b>Solid phase microextraction (SPME)</b>	A technique in which a small polymer-coated solid fiber is placed into a solution or above the headspace of a solid or liquid sample; analytes will diffuse into the coating until equilibrium is established; for GC, the fiber containing the sorbed sample is transferred to the GC and the trapped analytes are thermally desorbed into the column; in HPLC, solvent is used to rinse the sorbed analytes for eventual injection into the LC column; less popularly used in LC than in GC; see Chapters 2, 6, 7, 9 and 10.
<b>Solid phase trapping</b>	The use of an SPE cartridge or packed column to trap specific analytes that flow through the device; the packing material is chosen to selectively retain the analytes of interest and let non-interest compounds to pass through unretained.
<b>Solvent exchange</b>	The process of exchanging one solvent that may not be compatible with the analysis method for a solvent that is more compatible; in some cases, evaporation is used to remove a volatile solvent and the sample is reconstituted in a different solvent.
<b>Solvent strength</b>	Refers to the ability of a solvent to elute a particular solute or compound from a column. Described for HPLC by Lloyd Snyder for LEAC (LSC) adsorption chromatography on alumina; solvents were quantitatively rated in an eluotropic series. Less extensive data is available for silica and carbon adsorbents.
<b>Sonication</b>	Use of ultrasound to create vigorous agitation at the surface of a finely divided solid material; direct method: uses a specially designed inert acoustical tool (horn or probe = sonotrode) placed in sample-solvent mixture; indirect method: sample container is immersed in ultrasonic bath with solvent and subject to ultrasonic radiation; Dissolution is aided by ultrasonic process; heat can be added to increase rate of extraction; safe, rapid, best for coarse, granular materials; for indirect method, multiple samples can be done simultaneously; efficient contact with solvent; see Chapters 2 and 14.
<b>Soxhlet extraction</b>	A well-accepted technique for the extraction of compounds from a solid sample; the sample is placed in a disposable porous container (thimble); constantly refluxing fresh condensed solvent flows through the thimble and dissolves analytes that are continuously collected in a boiling flask; special glassware (a Soxhlet extractor) is designed to perform the extraction unattended; see Chapters 2 and 14.

<b>Spin column</b>	A small column that usually contains a packing material for sample cleanup or isolation; the sample is added to the column, which has a selective packing material; the column, in turn, fits into a small collector tube and is placed in a centrifuge; the spin tubes are very popular in handling biological samples for isolating DNA, RNA, and other biocompounds of interest; see Chapter 15.
<b>Spin filter</b>	Similar to a spin column, but, rather than the packing portion, a membrane filter is placed; the purpose of the filter is to remove particulates.
<b>Spin tube</b>	See <i>spin column</i> .
<b>Split injection</b>	An injection technique for GC in which only a portion of the sample is directed to the column (called the split ratio, 100:1, 50:1, etc.) so as not to overload the column and to ensure a representative sample reaches the column; the technique is simple, rugged, and protects the column. However, sample discrimination is possible; splitless injections are usually performed automatically; see Chapter 6.
<b>Splitless injection</b>	Rather than splitting the sample going to the GC column, all of the sample is directed into the GC column; this process ensures higher sensitivity than split injections, but flashback can occur, and a higher possibility of sample degradation is possible due to longer residence time in the hot injection port; see Chapter 6.
<b>Square well plates</b>	96-well plates that have square-shaped wells rather than the normal round bottom wells; see Chapter 9.
<b>Standard addition</b>	Process used to improve quantitation; necessary to have a pure standard of known concentration. An unknown concentration of sample is first injected to give a peak area; then to the unknown concentration is added a measured amount of pure compound. As a result of a new peak area, one can determine the amount of the original concentration; an alternative procedure is to add a constant amount of unknown concentration to a series of standards of pure substances and to plot the peak areas obtained against the known concentrations of the original standards. The slope of the line obtained gives the concentration of the unknown.
<b>Standards</b>	A sample that contains known quantities of the compounds of interest; Used to help identify sample peaks by comparing the time in which they elute to the retention times obtained through the injection of the sample under the same conditions. For quantitation, external standards are compounds that are used to construct calibration curves of detector output (peak area or peak height) vs. concentration; the concentration of unknowns are determined by fitting the detector output to the calibration curve. Internal standards are compounds of known concentration with different retention times that are added to the sample and relative detector responses between the internal standard and the unknown are compared in order to quantitatively measure unknown compounds.
<b>Stepwise elution</b>	Use of eluents of different compositions during the chromatographic run. These eluents are added in the stepwise manner with a pump or by a selector valve. Gradient elution is the continuous version of changing of solvent composition.



<b>Steric exclusion chromatography</b>	A major mode of LC in which samples are separated by virtue of their size in solution. Also known as size exclusion chromatography (SEC), gel permeation chromatography, gel filtration chromatography, or gel chromatography. SEC is most often used for polymer separation and characterization and sample cleanup; see Chapter 11.
<b>Stir bar sorbent extraction</b>	Principle similar to solid phase microextraction (SPME), but rather than the use of a coated fiber, a polymer-coated stir bar is used, greatly increasing the surface area, thus higher capacity and greater mass sensitivity; similar to SPME, equilibration requires tens of minutes; for GC, a special thermal desorption unit is needed to handle stir bar; in LC, bar is usually rinsed off-line; see Chapter 9.
<b>Straight phase chromatography</b>	See normal phase chromatography; see normal phase SPE.
<b>Strong anion exchanger</b>	Anion exchange packing with strongly basic ionogenic groups (e.g. tetraalkylammonium).
<b>Strong cation exchanger</b>	Cation exchange packing with strongly acidic ionogenic groups (e.g. sulfonic).
<b>Strong solvent</b>	In general, refers to a solvent that is a good solvent for a chemical compound; in chromatography, refers to the mobile phase constituent that provides a higher solvent strength that causes an analyte to elute more quickly from the column; in a water-acetonitrile binary solvent system for reversed-phase LC, acetonitrile would be considered to be the strong solvent.
<b>Sulfonyl cation exchanger</b>	A strong cation exchange functionality found in resin-based packings; usually propyl-SO <sub>3</sub> H; may come in other cationic forms such as sodium, ammonium, silver, and calcium.
<b>Supercritical fluid extraction (SFE)</b>	Uses supercritical fluid, most often carbon dioxide along with, or containing a small % of organic modifier for more polar analyte, to extract analytes from solid materials; supercritical fluid has the diffusivity of a gas and the solvent power of a liquid; requires a special SFE unit allowing precise control of pressure and temperature; analytes are collected in a cold trap, on an adsorbent, or in a liquid; a "green" extraction technique; see Chapter 14.
<b>Superheated water extraction</b>	Water is heated well above its boiling point in a closed pressurized system; heating changes dielectric constant and increases the solvating power such that it becomes "organic-like;" a "green" method for extracting organic analytes from solid matrices.
<b>Supported liquid extraction (SLE)</b>	A technique based on the principles of liquid-liquid extraction in which the aqueous phase is supported on a bed of highly purified, high surface area diatomaceous earth (in a tube, cartridge, or 96-well format); this aqueous phase may be buffered and may contain the sample to be partitioned; the organic phase is then percolated through the packed bed allowing for intimate contact with the dispersed aqueous phase. The effluent collected at the exit of the column contains the extracted analytes; compared to LLE, the SLE technique is miniaturized, easily automated, and provides excellent extraction efficiency; see Chapter 7.

<b>Surface area</b>	In an adsorbent, refers to the total area of the solid surface as determined by an accepted measurement technique, such as the BET Method, which uses nitrogen adsorption. The surface area of a typical porous adsorbent, such as silica gel, can vary from 100-600 square meters per gram.
<b>Surrogate samples</b>	A pure analyte which is extremely unlikely to be found in any sample, and which is added to a sample aliquot in known amounts before extraction, and is measured with the same procedures used to measure other sample components. A surrogate behaves similarly to the target analyte and is most often used with organic analytical procedures. The purpose of a surrogate analyte is to monitor method performance with each sample.
<b>Syringe filter</b>	A small plastic holder containing a membrane filter which has Luer lock fittings at both the top and the bottom so that it can be affixed to a syringe (which also has a Luer lock fitting) to pass a sample through the filtration media; syringe filter diameters can range up to 90 mm; see Chapter 5.
<b>Tedlar® bags</b>	Used for grab sampling of air or other gases; sampling bags are a whole-air sampling device for high-level VOCs and permanent gases. Several EPA, NIOSH, and OSHA methods exist for bag sampling for a variety of applications: stationary sources emissions, workplace atmospheres, ambient, indoor air quality, and breath analysis. The unique design of these Tedlar® sample bags incorporates the sampling septum directly in the valve (polypropylene or stainless steel construction), providing easier use and lighter weight than other styles.
<b>Thermal desorption</b>	The use of heat to desorb analytes from SPME fibers, SBSE bar, or solid matrices placed in a thermal desorption tube; see Chapter 6.
<b>Thermal extraction</b>	Uses high temperatures (below pyrolysis temperatures) to extract stable analytes from porous solid matrices; samples are placed in thermal desorption tubes, just like in thermal desorption; see Chapter 6.
<b>Time-integrated sampling</b>	In gas sampling, in order to obtain a more representative sample, time-integrated sampling is required. A flow restrictor is used to spread the sample collection flow over a specific time period to ensure an "average" composited or time-weighted average (TWA) sample. A TWA sample will accurately reflect the mean conditions of the ambient air in the environment and is preferred when, for regulatory or health reasons, a typical exposure concentration is required for a situation that may have high variability, as in an occupational setting.
<b>Titania</b>	TiO <sub>2</sub> , an uncommon adsorbent used in adsorption chromatography; also used as an SPE sorbent primarily for removal of phosphorous-containing compounds (e.g phospholipids).
<b>Trace enrichment</b>	Technique in which trace amounts of compounds are retained on an HPLC or precolumn packing out of a weak mobile phase or solution and then are eluted by the addition of a stronger mobile phase in a concentrated form. The technique has been most successfully applied in the concentration of trace amounts of hydrophobic compounds (e.g. polynuclear aromatic hydrocarbons) out of water using a reversed-phase packing. A strong solvent such as acetonitrile serves to elute the enriched compounds; see Chapters 2, 7, 9, 13, 16 and 18.
<b>Trapping</b>	Process of using a solid material (e.g. silica gel, polymer, inorganic sorbent, etc.) or liquid solution to physically or chemically retain solutes of interest from a diluted stream of liquid or gas; frequently used to concentrate analytes for more sensitive analysis.

<b>Tryptic digestion</b>	A method of selectively and reproducibly dissecting peptide chains of proteins to yield a characteristic pattern of smaller units which allow analysis of the parent protein by gradient elution RPLC; see Chapter 15.
<b>Turbulent flow chromatography</b>	Chromatography performed at very high linear velocities with large particles under conditions using high Reynolds numbers; at these conditions the H vs. v curves show a decrease in H with increase in v turbulent flow chromatography can be used for separation or sample preparation; see Chapters 16 and 17.
<b>Two-dimensional electrophoresis</b>	Two-dimensional gel electrophoresis, abbreviated as 2DE or 2D electrophoresis, is a form of gel electrophoresis commonly used to analyze proteins. Mixtures of proteins are separated by two properties in two dimensions on 2D gels. 2D electrophoresis begins with 1D electrophoresis, but then separates the molecules by a second property in a direction 90 degrees from the first. In 1D electrophoresis, proteins (or other molecules) are separated in one dimension, so that all the proteins/molecules will lie along a lane but that the molecules are spread out across a 2D gel. Because it is unlikely that two molecules will be similar in two distinct properties, molecules are more effectively separated in 2D electrophoresis than in 1D electrophoresis; see Chapter 15.
<b>Ultrafiltration</b>	Variety of membrane filtration in which hydrostatic pressure forces a liquid against a semi-permeable membrane. Suspended solids and solutes of high molecular weight are retained, while water and low molecular weight solutes pass through the membrane. This separation process is used for purifying and concentrating macromolecular (103-106 Da) solutions, especially protein solutions. Ultrafiltration is not fundamentally different from microfiltration, nanofiltration, or gas separation, except in terms of the size of the molecules it retains. Ultrafiltration is applied in cross-flow or dead-end mode, and separation in ultrafiltration undergoes concentration polarization; see Chapters 2, 15, 17 and 18.
<b>Ultrasonic sieving</b>	Used for the acceleration of sieving processes alternatively or complementary to the classical low frequency vibrators; especially useful for very fine powders in cases when ultrasound is often the only possibility to enable the sieving process.
<b>Ultrasonication</b>	The irradiation of a liquid sample with ultrasonic (>20 kHz) waves resulting in agitation. Sound waves propagated into the liquid media result in alternating high-pressure (compression) and low-pressure (rarefaction) cycles. During rarefaction, high-intensity sonic waves create small vacuum bubbles or voids in the liquid, which then collapse violently (cavitation) during compression, creating very high local temperatures; several regulatory methods for environmental samples (e.g. soils, solid waste) specify ultrasonication; see Chapters 2 and 14.
<b>Vacuum distillation</b>	Method of distillation whereby the pressure above the liquid mixture to be distilled is reduced to less than its vapor pressure (usually less than atmospheric pressure), causing evaporation of the most volatile liquid(s) (those with the lowest boiling points). This distillation method works on the principle that boiling occurs when the vapor pressure of a liquid exceeds the ambient pressure. Vacuum distillation is used with or without heating the mixture. Often used for higher boilers that might degrade at atmospheric pressure distillation; see Chapters 2 and 7.
<b>Vacuum filtration</b>	Using a vacuum to help pull liquids through a filter; especially useful for viscous liquids or very fine, low porosity filters; see Chapter 5.

<b>Vacuum manifold</b>	A manifold designed for SPE cartridges and SPE disks that uses a vacuum to pull liquids through the packed beds; pressurized manifolds are also available. Vacuum manifolds can process multiple samples from 8 to 24 at a time; see Chapter 9.
<b>Wash step (SPE)</b>	See <i>rinse step</i> ; see Chapter 9.
<b>Weak anion exchanger</b>	Anion exchange packing with weakly basic ionogenic groups (e.g. amino, diethylamino ethyl).
<b>Weak cation exchanger</b>	Cation exchange packing with weakly acidic ionogenic groups (e.g. carboxyl).
<b>Weighing</b>	A most fundamental sample preparation process in conducting sample preparation.
<b>Zirconia</b>	Porous zirconium oxide; used as a chromatographic sorbent usually coated or bonded with polymeric organic phase.
<b>Zwitterionic packing</b>	A packing material for HPLC that carries both positive and negative charges on its surface; zwitterionic packings are useful in the HILIC mode.

# Index

## A

- 2D electrophoresis.....212-215, 266
- 96-well plate, SPE .....(see *SPE formats*)
- 96-well plates.....33, 261
- 96-well plates, array/flexible.....121
- 96-well plates, filtration.....33, 238-239
- Accelerated solvent extraction (ASE).....13, (see *PFE*)
- Alumina, trap .....51
- American Association of Analytical Chemists (see *AOAC*) .....80
- Analyte adsorption in LLE .....63
- Analyte protectorates .....88
- Analytical cycle.....1-2, 17, 298
- Antibody purification .....196
- AOAC Method 2007.1 QuEChERS .....80
- ASTM, American Society for Testing Materials .....11
- Automation .....5, 33, 67, 109, 200, 203, 214, 223

## B

- Ball mill.....24
- Bead beater, tissue preparation .....247
- Bioanalysis, sample preparation.....227-254
- Biochromatography sample cleanup....196-198
- Biological fluids, organic volatiles.....49
- Biological tissue sample preparation....242-252
- Biological tissue sample preparation, workflow .....245

- Blending.....22
- Blood analysis, sample preparation.....228-235
- Breakthrough capacity, SPE .....122
- Breakthrough capacity, trapping .....48
- Buffer exchange (by SEC).....188
- Buffers .....61, 65, 196

## C

- Captiva filtration .....33
- Captiva ND Lipids .....33, 238-242, 303
- CaptiVac vacuum manifold .....108
- Cartridge, filter.....30
- Cartridges, SPE .....29, 99-100
- Centrifugation .....16
- Certify, for drugs of abuse .....153-155
- Chemical filtration.....114
- Chopping .....22
- Column switching cleanup .....172-180, 262
- Comprehensive multidimensional chromatography .....180
- Coning and quartering.....25-26
- Countercurrent distribution.....62
- Crushing.....22, 24
- Cryogenic focussing.....51-52

## D

dSPE .....	80-85, 91
Derivatization .....	9, 288-296
Derivatization, fluorescence detection .....	290, 292-293, 305
Derivatization, GC .....	295-296
Derivatization, GC, reagents .....	295
Derivatization, LC .....	287-293
Derivatization, LC, reagents .....	288
Derivatization, post-column .....	291-293
Derivatization, precolumn .....	290
Derivatization, UV-detection .....	289
Desalting using SPE .....	98
Desalting, biological samples .....	186, 196
Detergent removal .....	197, 266
Dialysis .....	198, 269
Dialysis, micro- .....	266, 271
Diatomaceous earth .....	65, 67
Dilution .....	3-4, 7, 9, 14-15, 153
Direct injection .....	35
Dispersive liquid-liquid microextraction (DLLME) .....	70-72
Dispersive liquid-liquid microextraction (DLLME), workflow .....	71
Dispersive SPE (see dSPE)	
Dispersive SPE, sorbent selection .....	85-87
Dispersive SPE, sorbents .....	80, 85-87
Dissolution .....	12
Distillation .....	15, 55, 300

Distribution coefficient (KD) .....	60-62
Dividers, laboratory .....	26
DNA purification, high-throughput .....	203
Dried blood spot analysis .....	232-235
Dried media spot analysis .....	232-235
Drugs of abuse (by SPE) .....	153-155
Drying .....	28

## E

Ecospheres .....	161, 163
Electrodialysis .....	199
Electromembrane extraction (EME) .....	278-279
Emulsions in LLE .....	63, 65
Environmental samples, proprietary pollutant SEC cleanup (EPA Method 3640A) .....	161-164
Error, sources of .....	4, 17
European Union QuEChERS Method (EN15662) .....	80

## F

Filter paper, fluted .....	30
Filter plate, 96-well (Captive).....	33
Filter vial .....	34
Filter, membrane.....	29-32
Filter, membrane, chemical resistance .....	32
Filter, membrane, holdup volume.....	31
Filter, paper.....	29-30
Filter, spin .....	31
Filter, syringe .....	30
Filtration.....	16, 29-34, 197
Filtration, vacuum .....	30
Flash chromatography cleanup .....	170-171
Flashback, GC injection .....	36
Flow injection extraction .....	76
Food priority pollutant SEC cleanup (EPA Method 3640A).....	161
Forced-flow leaching.....	182
Formic acid removal .....	282-283
Freeze drying .....	see <i>lyophilization</i>
Freezer mill .....	22, 24, 244, 247
Funnel, separatory.....	56

## G

Gas phase extraction.....	14
Grinding .....	22, 24, 246
Grinding mill.....	24
Grinding, dry and wet.....	23

## H

Headspace single drop microextraction (HS-SDME).....	46-47, 75
Headspace solid phase microextraction (HS-SPME).....	46
Headspace, dynamic (purge and trap).....	10, 36, 43, 48-50
Headspace, static .....	10, 42-43
Heart cutting .....	173, 179, 300
HF-LPME, three phase.....	276
HF-LPME, two phase.....	276
Hollow fiber liquid-liquid-liquid microextraction (HF-LLLME).....	276
Hollow fiber liquid-phase microextraction (HF-LPME) .....	273-277
Homogenization .....	12, 22, 246, 251
Hydromatrix .....	67

## I

Injection, COC with solvent vapor exit (SVE) .....	40
Injection, cool on-column (COC).....	36-37
Injection, large volume (LVI) .....	39-40
Injection, programmed temperature vaporization (PTV).....	37-38
Injection, split/splitless .....	37
Injection, splitless/pulsed .....	39
Injection, syringe.....	35
Inlet, multimode (for GC) .....	38
Inlet, sample (for GC).....	36-41
Internal standard .....	5-6, 47, 70, 81, 83, 91, 109, 120, 233, 251, 257
Ion pairing.....	59, 65

## J

Just enough sample preparation.....297-306

## L

LC-MS adduct formation .....257, 264, 266

LC-MS sample pre-treatment.....255-268

LC-MS, ion suppression/ion enhancement.....255, 257, 264-266

LC-MS, macromolecule sample preparation.....265-266

LC-MS, small molecule sample preparation.....261-264

LC-MS, volatile buffers and solvents....259-260

Liquid-liquid extraction (LLE) .....15, 55-64

Liquid-liquid extraction (LLE), back extraction .....61

Liquid-liquid extraction (LLE), bioanalysis .....261

Liquid-liquid extraction (LLE), continuous .....61

Liquid-liquid extraction (LLE), theory...58-59

Liquid-phase microextraction (LPME).....70, 273

Liquid-solid extraction.....11-12

LLE, solvents .....60

LLE, theory .....58-59

LLE, workflow .....57

Luke method.....79

Lyophilization .....3, 16, 28, 55, 198, 205, 246, 282, 300

## M

Macerating .....22

Magnesium sulfate, anhydrous (for QuEChERS) .....79, 82, 85-87

Matrix solid phase dispersion (MSPD).....14, 143-144, 247

Membrane extraction with sorbent interface (MESI) .....49-50

Membrane techniques .....269-280

Metal removal, biological samples.....197

Microextraction .....70

Microextraction, solid phase .....(see *SPME*)

Microextraction, solid phase, headspace (HS-SPME).....45

Microwave-accelerated extraction .....(see *MAE*)

Microwave-assisted extraction (MAE) .....11, 13, 191

Milling.....22, 24

Mincing.....22

Molecular-imprinted polymers (MIPs) .....148-149

Multidimensional liquid chromatography .....204-213

Multiple reaction monitoring (MRM) (in mass spectrometry) .....68, 79, 91, 155, 241, 256, 264, 302

Multiple headspace extraction (MHE) .....43



## N

- Nucleic acid constituent sample preparation, high-throughput .....203
- Nucleic acid constituent sample preparation, traditional.....200-202

## P

- Particle size reduction .....21-24
- Peptide mapping, automation .....223
- Peptide mapping, sample preparation.....216-222, 266
- Pesticides.....39-41, 79, 162
- Plant fibers.....52
- Plasmid purification .....197
- PLgel, SEC sample cleanup .....163-164
- Polarity index (P<sup>i</sup>).....60
- Polymers, synthetic.....52
- Pressing .....22
- Pressurized fluid extraction (PFE) .....11, 13, 192
- Primary-secondary amine (PSA).....80, 84-87, 91, 145
- Protein aggregate cleanup (by SEC) ....168-169
- Protein concentration .....198-199
- Protein precipitation .....235-239, 303
- Protein precipitation, lipophilic compound removal.....240-242

- Protein removal techniques .....235-239
- Protein removal, high-abundance .....206, 210
- Protein sample preparation, automation .....214-215
- Protein sample preparation, modern....211-215
- Protein sample preparation, removal from gels .....212
- Protein sample preparation, traditional.....205-209
- Pulverizing.....22, 24, 247
- Purge and trap.....(see *dynamic headspace*)
- Pyrolysis .....10, 51-52

## Q

- QuEChERS .....76, 80-92
- QuEChERS, applications .....88-89
- QuEChERS, workflow .....81, 90
- QuEChERS, steps in performing.....81-84

## R

- Removal of electrophilic reagents .....282
- Restricted access media (RAM) .....147, 262
- Rhodium removal.....284-285
- Riffing.....26

## S

- Salting out effect .....59, 70, 78
- Salting out extraction.....78-79
- Sample prep for genomics.....200-203
- Sample prep for proteomics .....204-215
- Sample size reduction.....25-27
- Sample tracking.....17
- Sample, biological .....195-223
- Sample, collection .....3
- Sample, drying.....28
- Sample, gas .....9
- Sample, solid .....181-193
- Sample, storage.....3, 18
- Sample, transport .....3, 18
- Sampling.....17-20
- Sampling plan.....17
- Sampling, error .....27
- Sampling, grab .....9
- Sampling, headspace .....10
- Sampling, primary.....1, 17-18
- Sampling, secondary .....25-27
- Scavengers .....281-285
- SEC calibration curve.....166-167
- Sedimentation.....16
- SFE (supercritical fluid extraction) .....11, 13
- SFE, method development.....188-190
- Shake-flask .....181
- Sieving .....22, 26
- Silica gel .....9, 49, 119, 170
- Single drop microextraction (SDME) ....46, 73-75
- Single drop microextraction (SDME),  
solvents.....74
- Size-exclusion chromatography  
(SEC) .....160-169
- Solid phase extraction .....(see *SPE*)
- Solid phase microextraction .....(see *SPME*)
- Solubility, phase solubility in LLE .....10, 64
- Solute binding in LLE .....64
- Solvent extraction .....(see *LLE*)
- Sonication (ultrasonic agitation) .....12, 181, 246
- Sorbents, dispersive SPE .....80
- Soxhlet extraction, modern.....184
- Soxhlet extraction, traditional.....11-12, 181-182
- SPE (solid phase extraction)
- SPE apparatus .....107-108
- SPE apparatus, vacuum manifold  
(96-well plate) .....108
- SPE apparatus, vacuum manifold  
(cartridge) .....107-108
- SPE automation .....104, 109

SPE formats	
SPE formats, 96-well plate .....	104-105
SPE formats, cartridge .....	29, 99-100
SPE formats, coated fiber (for SPME) ....	105-106
SPE formats, coated stir bar (for SBSE) .....	106
SPE formats, disk .....	29, 101-103
SPE formats, pipette tip .....	103
SPE uses .....	97-98
SPE vs. HPLC .....	96
SPE vs. LLE .....	95-96
SPE, advantages/disadvantages .....	95
SPE, affect of flow rate .....	127
SPE, bind-elute mode .....	110
SPE, dispersive (dSPE) .....	80-82, 84-87, 91
SPE, drugs of abuse .....	153-155
SPE, immobilized phases .....	152-153
SPE, immunoaffinity extraction .....	150-151, 264
SPE, ion removal .....	155
SPE, ion-specific .....	152
SPE, matrix adsorption mode .....	114
SPE, method development .....	112, 116-125
SPE, method development workflow ...	125
SPE, method validation .....	126
SPE, mixed-mode .....	156-157, 261-262
SPE, multimodal extractions .....	156-157
SPE, mycotoxin phase .....	156
SPE, on-line (column switching) .....	172-180
SPE, phases .....	112, 115
SPE, polymeric sorbents .....	261
SPE, recommended textbooks .....	131-132
SPE, specialty phases .....	145-146
SPE, steps .....	110-114
SPE, uses of .....	97-98
Split ratio .....	37
SPME .....	10, 70, 105-106, 133-141, 263
SPME, advantages/disadvantages .....	140
SPME, fiber chemistry .....	136
SPME, headspace .....	45
SPME, in-tube .....	263
SPME, principles .....	135-136
SPME, steps .....	136-139
Stir bar sorbent extraction (SBSE) .....	16, 106
StratoSpheres .....	283-285
Stripping, gas phase .....	48, (see <i>dynamic headspace/purge and trap</i> )
Supercritical fluid extraction (SFE) .....	13, 185-190
Supported liquid extraction (SLE) .....	65-69
Supported liquid extraction (SLE), solvents .....	68
Supported liquid membrane (SLM) .....	272
Supported liquid extraction (SLE), 96-well format .....	67
Supported liquid extraction (SLE), steps in .....	66-67

## T

- Thermal desorption.....10, 48-49, 51
- Thermal extraction.....10, 50
- Time, typical sample preparation.....4
- Tissue sample preparation,  
instrumentation.....246-247, 250
- Tissue, digestion .....249
- Trapping, liquid .....9
- Trapping, adsorbents for .....48, 51-52
- Trapping, cold .....48, 51
- Trapping, solid phase .....9, 11, 48-49
- Turbulent flow chromatography.....262

## U-V

- Ultrafiltration.....199, 271
- United States Department of  
Agriculture (USDA) .....79
- United States Environmental  
Protection Agency .....(see *USEPA*)
- United States Pharmacopoeia .....(see *USP*)
- USEPA Method 3535A, disk SPE .....102
- USEPA Method 3550, sonication .....181
- USEPA Method 3640A, SEC cleanup ....161
- USEPA Method 8330A,  
nitroaromatics.....79
- USEPA SEC calibration mixture .....162-164
- USP, Method 467, residual solvents ....45
- Volatile organic compounds (VOCs) .....35-54

## W

- Whole blood processing.....230
- Worksheet, questions .....6-7

# Matrix/Analyte Index

## A

Air, volatile organic compounds .....	51
Animal fibers .....	52
Animal food origin, pesticides (QuEChERS) .....	89
Animal tissue, PCBs .....	192
Animal tissue, pesticides .....	243
Apples, pesticides (by QuEChERS) .....	90-92
Avocados, pesticides (QuEChERS) .....	89

## B

Baby food, pesticides (QuEChERS) .....	89, 144
Bananas, pesticides (QuEChERS) .....	89
Beans, pesticides (QuEChERS) .....	89
Beverages, fragrances in .....	49
Bivalves, polyaromatic hydrocarbons .....	144
Blood, alcohol in .....	42, 45
Bovine liver, quinolone antibiotics (QuEChERS) .....	89
Bovine liver, sulphonamide antibiotics (QuEChERS) .....	89

## C

Carrots, pesticides (QuEChERS) .....	89
Chicken muscle, sulphonamide antibiotics .....	89
Clover leaves, isoflavones .....	144
Coffee, flavor components .....	45
Cooking oil, acrylamide (QuEChERS) .....	89
Cork stopper, chloroanisoles .....	134
Corn, aflatoxins .....	151
Cucumbers, pesticides (QuEChERS) .....	89

## D

Drugs, residual solvents .....	46-47
--------------------------------	-------

## F

Fish, lipids .....	191
Fish, methyl mercury .....	134
Fish, mycotoxins .....	248
Fish, pesticides (QuEChERS) .....	89
Fish, PCBs (QuEChERS) .....	89
Fish, polynuclear aromatic hydrocarbons .....	89, 303-305
Food, vitamins .....	191
Foodstuff, antibacterial residues .....	144
French fries, acrylamide (QuEChERS) .....	89
Fruit juice, flavor components .....	45, 144
Fruit, pesticides (by MSPD) .....	144
Fruits and vegetables, alternaria toxins .....	128-130
Fruits and vegetables, pesticides (QuEChERS) .....	76, 79, 80-86, 89, 303

## G

Green pepper, pesticides (QuEChERS) .....	89
Green tea, pesticides (QuEChERS) .....	89
Ground water, beta-blockers .....	179

## H

Honey, pesticides in .....	68-69
Human plasma, ribavirin .....	152-153
Human serum, digoxin .....	179
Hydrocarbon processing stream, oxygenates and aromatics .....	179

## K

Ketones and aldehydes in air (EPA TO-11) .....	11
Ketones and aldehydes in air, ASTM (Method D5197-03) .....	11

## L

Lemon oil, pesticides (QuEChERS) .....	89
Lemons, pesticides .....	157
Lettuce, pesticides (QuEChERS) .....	89

## M

Meat, veterinary drugs (QuEChERS) ....	89
Milk, antibiotics .....	144, 179

## O

Olive oil, pesticides (QuEChERS) .....	89
Oranges, pesticides (QuEChERS) .....	89

## P

Peanut butter, aflatoxins .....	151
Pear, pesticides (QuEChERS) .....	89
Pepper, pesticides (QuEChERS) .....	89
Plasma, 17-beta-estradiol .....	179
Plasma, fluticasone propionate .....	302
Plasma, immunosuppressants .....	179
Plasma, indometacin .....	179
Plasma, nortriptyline .....	179
Plasma, vitamins .....	179
Polymer, additives .....	49-50, 191
Pork sausage, SEC cleanup .....	165

## R

Rat brain tissue, desipramine .....	246-248
Rice, pesticides (QuEChERS) .....	89

## S

Sediment, organochlorine pesticides.....	191
Sediment, organochloro pesticides .....	191
Shrimp, hormones (QuEChERS).....	89
Soil, BTEX .....	49
Soil, non-volatile and semi-volatile organic compounds .....	134, 181
Soil, petroleum hydrocarbons.....	50
Soil, polynuclear aromatic hydrocarbons (QuEChERS) .....	89
Soil, polynuclear aromatic hydrocarbons SEC cleanup.....	164
Soil, sandy, pentachlorophenol.....	184
Soils and sludges, organochloro pesticides .....	186, 191
Solid waste, pesticides, PCBs, hydrocarbons .....	192
Spices, Sudan dye (by column switching) .....	175-177
Spinach, pesticides (QuEChERS) .....	89
Strawberries, pesticides (QuEChERS) .....	89

## T

Tea, black and green, pesticides (QuEChERS) .....	89
Tea, organochloro pesticides (by SPME).....	134
Tissue, veterinary drugs.....	144
Tomato, pesticides .....	89, 157

## V

Vegetable oil, flavor components .....	45
Vegetables, non-ionic pesticides .....	79

## W

Water, acidic pesticides.....	98
Water, carbamate pesticides .....	292-293
Water, Demerol .....	279
Water, drinking, non-halogenated volatiles (EPA 502.1) .....	49
Water, drinking, volatile aromatics (EPA 503.1) .....	49
Water, flavor components .....	45
Water, herbicides (trace enrichment)....	178
Water, nitroaromatic explosives .....	75, 79
Water, pesticides (by DLLME) .....	72
Water, pesticides (by SLE) .....	67
Water, pesticides (by trace enrichment) .....	97
Water, phenols .....	277
Water, phenylurea herbicides.....	134
Water, phthalates .....	134, 141-142
Water, polynuclear aromatic hydrocarbons .....	70
Water, rain, hydrocarbons in .....	49, 134
Water, synthetic sweeteners .....	127
Water, trace explosives .....	79
Water, trace organics .....	75
Water, trace organics (EPA Method 3535A) .....	102
White flour, pesticides (QuEChERS) ....	89
Whole blood, pharmaceuticals (QuEChERS) .....	89
Wine, isobutylpyrazine.....	134

## Notes



## Notes

## Notes



## Reliably extract and concentrate samples from complex matrices

Sample preparation is an essential part of successful chromatography. It extends column lifetime, reduces the need for repeated samples, and minimizes interferences that can jeopardize your separation, detection, and quantification.

Agilent offers the most complete line of sample prep products across the full spectrum of instrumentation. These include:

- **Pre-packaged QuEChERS kits** – make sample preparation faster, easier, and more reliable.
- **Captiva Filtration products** – improve both system performance and analytical quality and prevent extractables, proteins, lipids, or other contaminants from interfering with the accuracy of your analyses.
- **Chem Elut products** – for supported liquid extraction (SLE) reduce solvent usage and time over traditional liquid-liquid extraction.
- **Bond Elut SPE products** – selectively remove interferences and/or analytes from challenging matrices. Choose from the largest selection of sorbent formats on the market today.

[www.agilent.com/chem/sampleprep](http://www.agilent.com/chem/sampleprep)

## For more information

To learn more about the Agilent Sample Preparation portfolio, visit [agilent.com/chem/sampleprep](http://agilent.com/chem/sampleprep)

To find your local Agilent Representative or Agilent Authorized Distributor, visit [agilent.com/chem/contactus](http://agilent.com/chem/contactus)

Buy online:  
[agilent.com/chem/store](http://agilent.com/chem/store)

U.S. and Canada  
**1-800-227-9770**  
[agilent\\_inquiries@agilent.com](mailto:agilent_inquiries@agilent.com)

Europe  
[info\\_agilent@agilent.com](mailto:info_agilent@agilent.com)

Asia Pacific  
[adinquiry\\_aplsca@agilent.com](mailto:adinquiry_aplsca@agilent.com)

India  
[lsca-india\\_marketing@agilent.com](mailto:lsca-india_marketing@agilent.com)

This information is subject to change without notice.

© Agilent Technologies, Inc. 2013  
Printed in Canada November 13, 2013  
5991-3326EN

